

SYSMAC C1000H/C2000H

SYSMAC C60H

Smallest PLC in the SYSMAC C Series

Programmable Controllers

SYSMAC CPM1A

SYSMAC C200H
/C200HS

SYSMAC C20H
/C28H
/C40H

V1-type CPU Units
Now Available

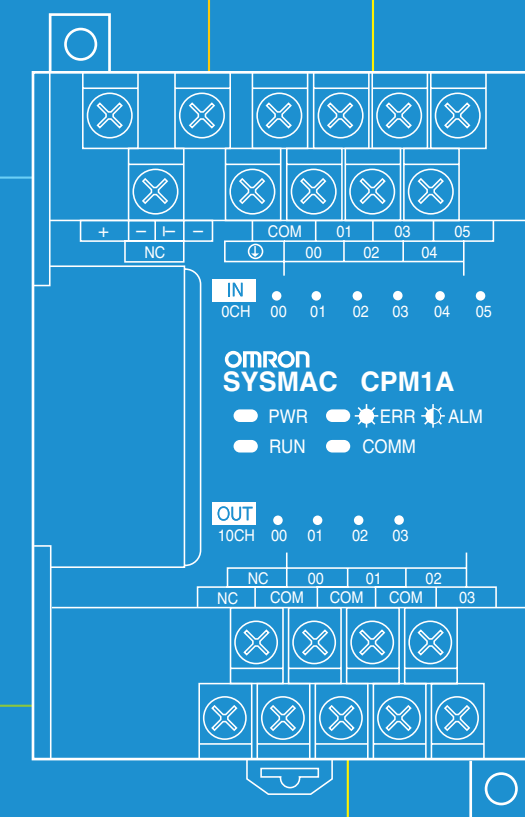

SYSMAC CPM1A

SYSMAC C20P/C28P/C40P

Transistor output models are new additions to the CPM1A Series.

OMRON Corporation

FA Systems Division H.Q.
66 Matsumoto
Mishima-city, Shizuoka 411-8511
Japan
Tel: (81)55-977-9181
Fax: (81)55-977-9045

Regional Headquarters

OMRON EUROPE B.V.
Wegalaan 67-69, NL-2132 JD Hoofddorp
The Netherlands
Tel: (31)2356-81-300/Fax: (31)2356-81-388

OMRON ELECTRONICS LLC
1 East Commerce Drive, Schaumburg, IL 60173
U.S.A.
Tel: (1)847-843-7900/Fax: (1)847-843-8568

OMRON ASIA PACIFIC PTE. LTD.
83 Clemenceau Avenue,
#11-01, UE Square,
Singapore 239920
Tel: (65)6835-3011/Fax: (65)6835-2711

Authorized Distributor:

Note: Specifications subject to change without notice.

Cat. No. P039-E1-11
Printed in Japan
0404-1M

SYSMAC

CPM1A

Programmable Controllers

The Smallest PLC in the SYSMAC Family Shows Just How Far Downsizing Can Go

The SYSMAC C Series began developing a wide range of Programmable Controllers to meet factory automation needs in 1973. And now the CPM1A joins the C Series history as a small PLC that has all the power of previous small PLCs but requires far less mounting space. The CPM1A also provides flexibility in I/O capacity ranging from 10 to 100 I/O points. The CPM1A can replace relay control, help distribute I/O, work as a miniature machine controller or sensor controller, or fill many other vital roles in factory automation.

The 10-point CPU is approximately the size of a PC Card.

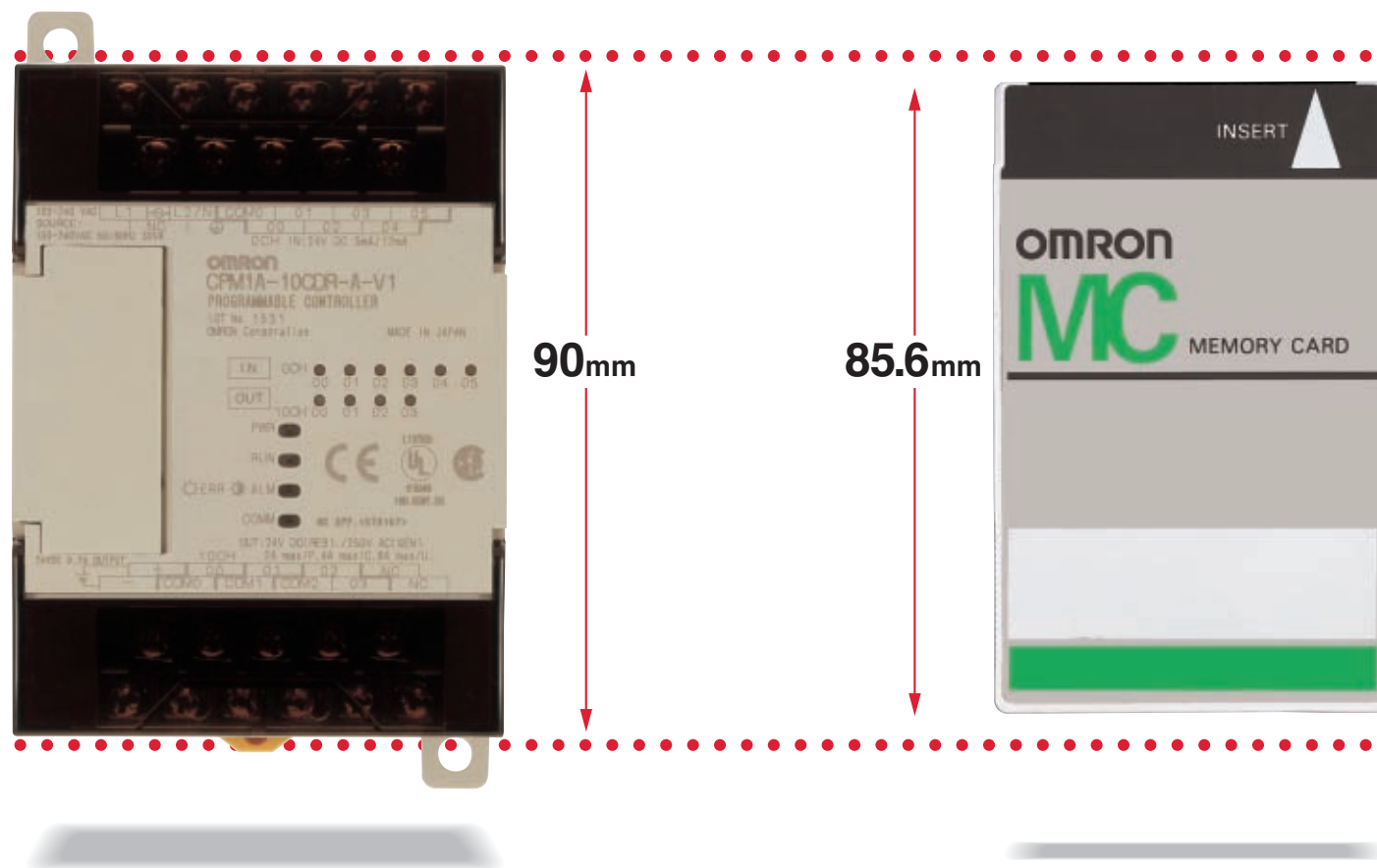

Contents

| | |
|-------------------------------------|--------------|
| System Configuration | 6-7 |
| CPM1A Line-up | 6 |
| CPM1A System Configuration | 7 |
| External Dimensions | 7 |
| Specifications | 8-15 |
| General Specifications | 8 |
| Power Consumption for DC Models | 8 |
| Performance Specifications | 9 |
| I/O Specifications | 10 |
| CPM1A-DRT21 DeviceNet I/O Link Unit | 13 |
| Temperature Sensor Units | 13 |
| Communications Adapter | |
| Specifications CPM1-CIF01/CIF11 | 14 |
| CPM2C-PA201 AC Power Supply Unit | 15 |
| Functions | 16-21 |
| Input Interrupts | 16 |
| Quick-response Inputs | 17 |
| High-speed Counter | 17 |
| Interval Timer Interrupts | 18 |
| Analog Setting | 18 |
| Pulse Output Function | 19 |
| Communications | 20 |
| Programming Instructions | 22-25 |
| Peripheral Devices | 26 |
| Standard Models | 27-29 |
| Expansion Memory Unit | 30 |

This catalog contains information necessary to select models.

It does not include precautionary information. Please refer to the CPM1A manuals for the required information.

Flexible Control and Plenty of Power in the Minimum Body Size

The CPM1A can be easily built into a wide array of machines or control panels. For example, you can use the CPM1A to control a few more I/O points on existing lines without having to install a new control panel. Just install the CPM1A in available space to control only the required number of I/O. The CPM1A was born to reduce waste in the factories by effectively using valuable space.

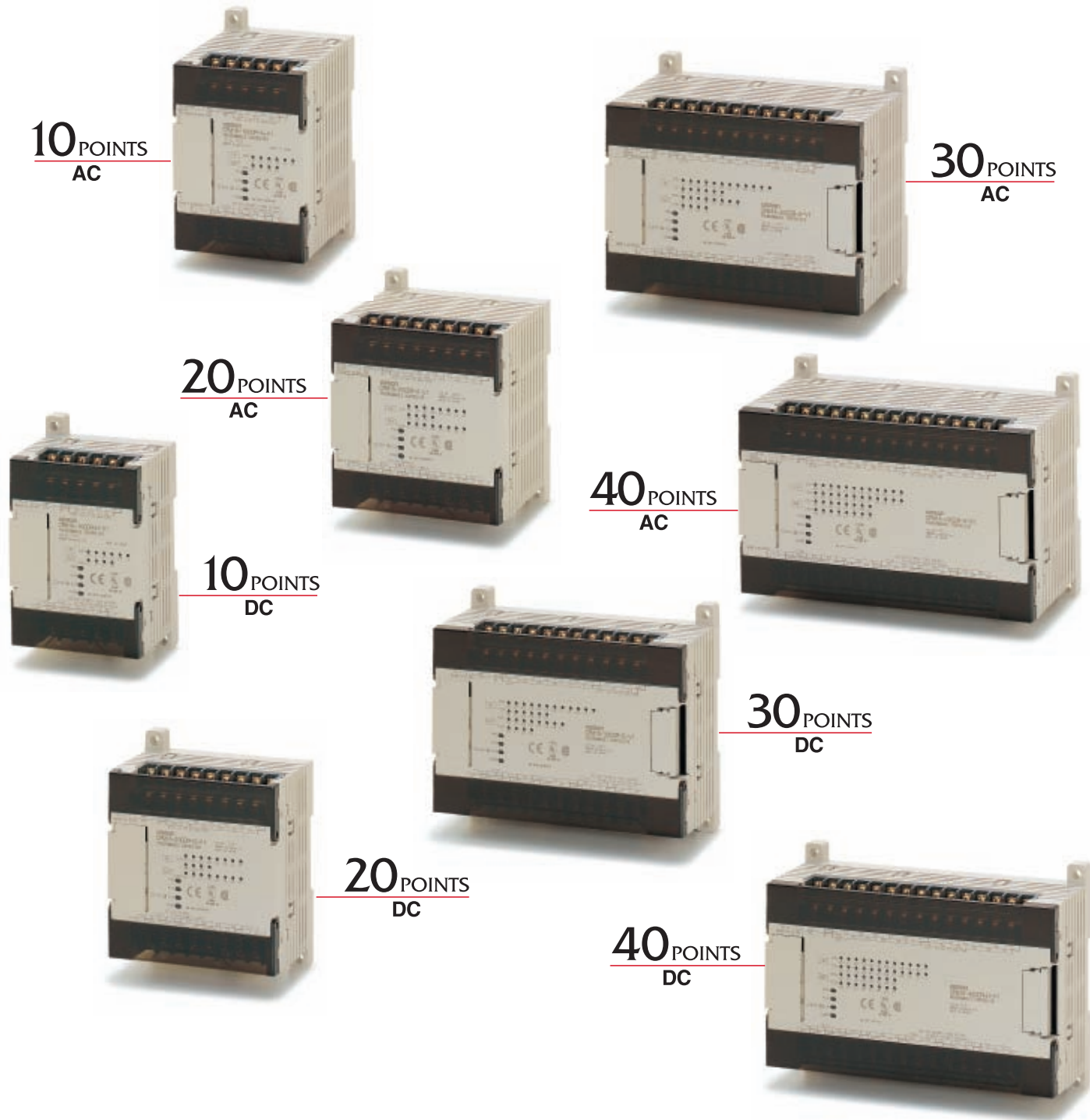

Select Units to Control from 10 to 100 I/O Points

CPUs are available with from 10 to 40 I/O points and, in combination with Expansion I/O Units, can be used to control a total of from 10 to 100 points.

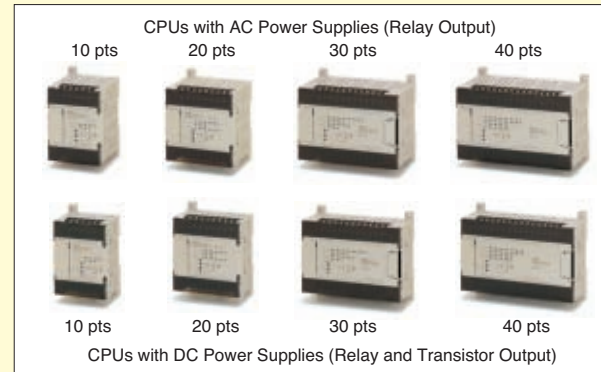

Only 30- and 40-point CPUs support Expansion I/O Units. Up to three Expansion I/O Units can be connected.

CPM1A-20EDR1/-20EDT(1)
CPM1A-8ED/-8ER/8ET(1)

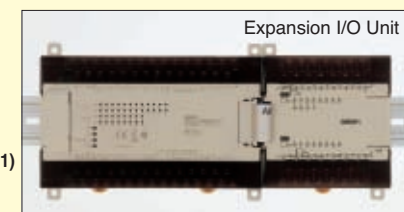

SYSMAC CPM1A

Easy Connection to Programmable Terminals

An optional Communications Adapter supports Host Link or NT Link connections for high-speed communications with OMRON PTs.



Windows-based Support Software

The Windows-based CX-Programmer Support Software reduces software development time and provides powerful monitoring and debugging functions. Other Windows applications can be used and the programming environment has been greatly improved.

Reduce Software Development Time with Windows-based CX-Programmer

CX-Programmer's many monitoring and debugging functions provide powerful support for multiple program development.

- User-friendly operations
- Powerful display/monitoring functions
- Powerful debugging functions
- Remote programming and monitoring
- Maintenance functions
- Data compatibility with Windows applications

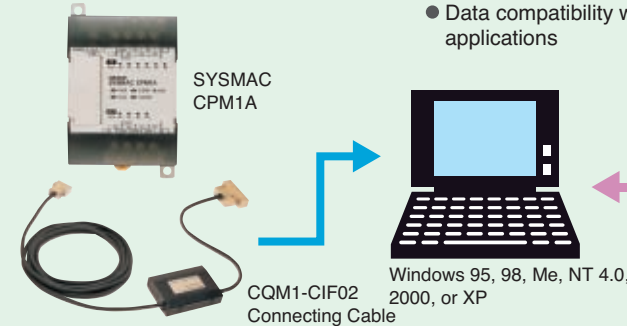

Programming Consoles

Hand-held Programming Consoles are ideal for onsite startup and adjustments.



Full Functionality in a Compact Body

Plenty of programming capacity and a large instruction set handle even complex control operations.

| | |
|--------------------------|--------------------------|
| User memory: 2,048 words | Basic instructions: 14 |
| Data memory: 1,024 words | Special instructions: 79 |
| Timers/Counters: 128 | Analog adjustments: 2 |

High-speed Execution

LOAD instructions execute at 1.7 μ s and MOVE instructions execute at 16.3 μ s for fast program execution. High-speed scanning is thus possible even with large programs. Interrupt inputs and quick-response inputs can be used to handle high-speed pulses that are too fast for the scan time.

System Configuration

■ CPM1A Line-up

- CPU with AC Power Supply** • DC input • RY output / TR output
CPU with DC Power Supply • DC input • RY output / TR output

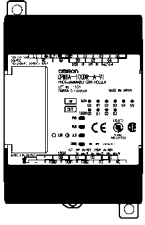

10 I/O points
(Expansion not possible)

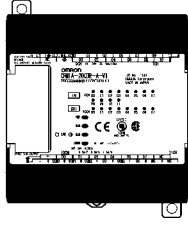

20 I/O points
(Expansion not possible)

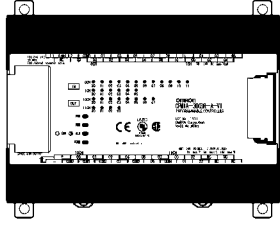

30 I/O points

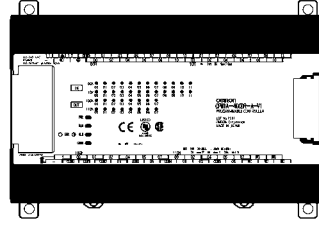

40 I/O points

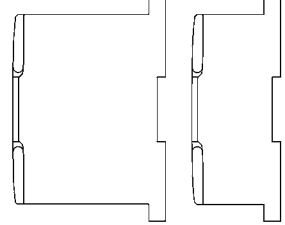

Expansion I/O Unit

- DC input
- RY output / TR output

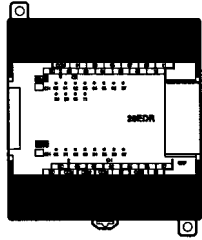

20 I/O points

Expansion I/O Unit

- DC input
- RY output / TR output

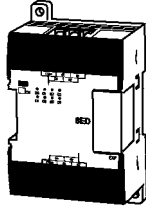

DeviceNet I/O Link Unit

CPM1A-DRT21

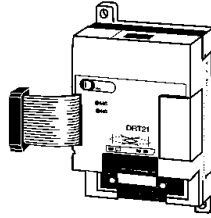

CompoBus/S I/O Link Unit

CPM1A-SRT21

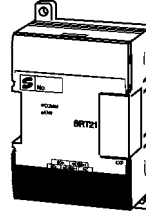

Analog I/O Unit

CPM1A-MAD01
-MAD11

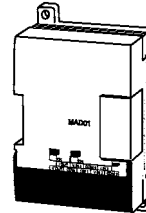

Temperature Sensor Units

CPM1A-TS001
TS002
TS101
TS102



RS-232C Adapter

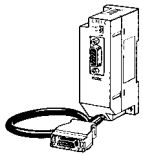

CPM1-CIF01

RS-422 Adapter

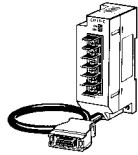

CPM1-CIF11

System Configuration

■ CPM1A System Configuration

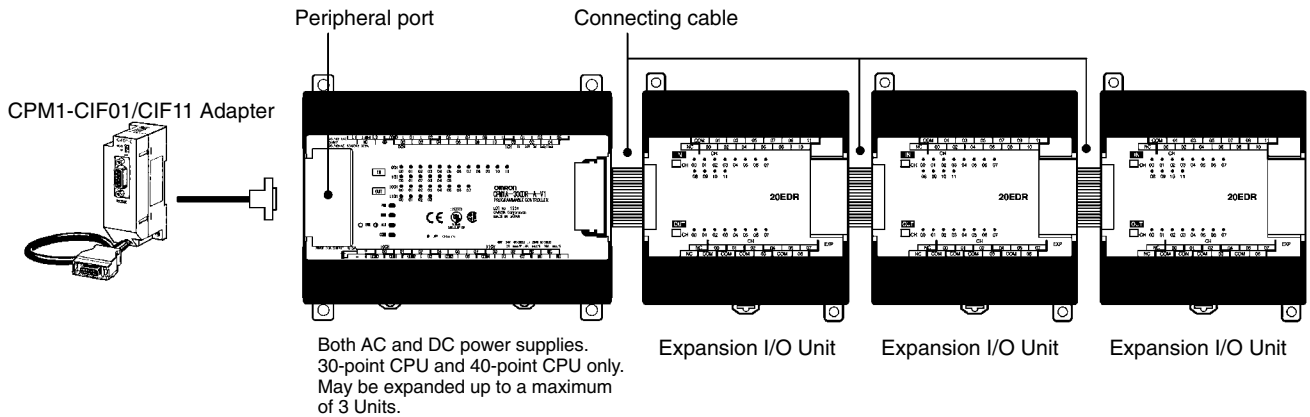

Connection Groups for Expansion Units

| Group 1 (G1) | Group 2 (G2) |
|--|-----------------|
| Expansion I/O Units, Analog I/O Unit, CompoBus/S I/O Link Unit DeviceNet I/O Link Unit CPM1A-TS001/101 | CPM1A-TS002/102 |

In addition to the CPU Unit, Expansion Units from the groups indicated in the above table can be combined as shown below.

Possible Expansion Unit Combinations

| Expansion Unit 1 | Expansion Unit 2 | Expansion Unit 3 |
|------------------|------------------|------------------|
| G1 | G1 | G1 |
| G2 | G1 | --- |

- Note:**
- Expansion Units 1, 2, and 3 can be mounted in any order.
 - Only one Expansion Unit can be mounted if an NT-AL001 is connected to the RS-232C port.

■ External Dimensions

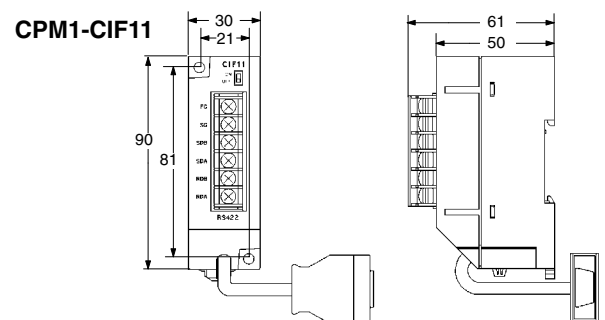
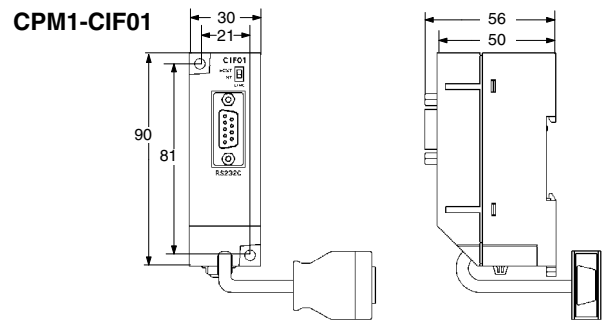
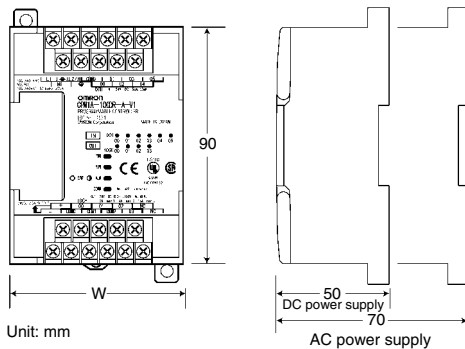

| Model | W (mm) |
|-----------------------|-------------------|
| CPM1A-10CD□-A-V1/D-V1 | 66 |
| CPM1A-20CD□-A-V1/D-V1 | 86 |
| CPM1A-30CD□-A-V1/D-V1 | 130 |
| CPM1A-40CD□-A-V1/D-V1 | 150 |
| CPM1A-20ED□ | 86 (depth: 50 mm) |
| CPM1A-8E□/SRT21 | 66 (depth: 50 mm) |
| CPM1A-MAD01 | 66 (depth: 50 mm) |
| CPM1A-TS□□/MAD11 | 86 (depth: 50 mm) |
| CPM1A-DRT21 | 60 (depth: 50 mm) |

Specifications

■ General Specifications

| Item | | 10-point I/O | 20-point I/O | 30-point I/O | 40-point I/O |
|------------------------------------|---------------------------------|--|--|--|--|
| Power supply voltage/ frequency | AC power supply | 100 to 240 VAC, 50/60 Hz | | | |
| | DC power supply | 24 VDC | | | |
| Operating voltage range | AC power supply | 85 to 264 VAC | | | |
| | DC power supply | 20.4 to 26.4 VDC | | | |
| Power consumption | AC power supply | 30 VAC max. | | 60 VAC max. | |
| | DC power supply | (See below.) | | | |
| Inrush current | | 30 A max. | | 60 A max. | |
| External power supply (AC only) | Power supply voltage | 24 VDC | | | |
| | Power supply output capacity | 200 mA | | 300 mA | |
| Insulation resistance | | 20 MΩ min. at 500 VDC between the AC terminals and the protective earth terminal. | | | |
| Dielectric strength | | 2,300 VAC at 50/60 Hz for one minute with a leakage current of 10 mA max. between all the external AC terminals and the protective earth terminal. | | | |
| Noise resistance | | Conforms to IEC61000-4-4, 2 kV (power lines) | | | |
| Vibration resistance | | 10 to 57 Hz with an amplitude of 0.075 mm, and 57 to 150 Hz with an acceleration of 9.8 m/s ² in the X, Y, and Z directions for 80 minutes each (i.e. swept for 8 minutes, 10 times). | | | |
| Shock resistance | | 147 m/s ² in the X, Y and Z directions 3 times each. | | | |
| Ambient temperature (operating) | | 0° to 55°C | | | |
| Ambient humidity (operating) | | 10% to 90% (no condensation) | | | |
| Ambient environment (operating) | | With no corrosive gas | | | |
| Ambient temperature (storage) | | -20° to 75°C | | | |
| Terminal screw size | | M3 | | | |
| Power supply holding time | | 10 ms min. for AC models, and 2 ms min. for DC models | | | |
| Weight | | AC model: 400 g max. DC model: 300 g max. | AC model: 500 g max. DC model: 400 g max. | AC model: 600 g max. DC model: 500 g max. | AC model: 700 g max. DC model: 600 g max. |

Note: The specifications of the Expansion I/O Unit are the same as for the CPU except that the power is supplied from the CPU and the weight is 300 g.

■ Power Consumption for DC Models

The power consumptions for CPM1A CPU Units and Expansion I/O Units are given in the tables below. Use them to calculate the required power supply capacity. The CPM2C-PA201 provides a 15-W power supply. Any surplus power that is beyond that required for the PLC itself can be used for servicing devices such as sensors.

| CPM1A CPU Unit | Power consumption | Expansion |
|------------------------|-------------------|---------------|
| CPM1A-10CDR-D-V1 | 3.5 W | Not supported |
| CPM1A-20CDR-D-V1 | 4.5 W | Not supported |
| CPM1A-30CDR-D-V1 | 5.5 W | Supported |
| CPM1A-40CDR-D-V1 | 6.5 W | Supported |
| CPM1A-10CDT-V1/T1-D-V1 | 3 W | Not supported |
| CPM1A-20CDT-V1/T1-D-V1 | 3.5 W | Not supported |
| CPM1A-30CDT-V1/T1-D-V1 | 4 W | Supported |
| CPM1A-40CDT-V1/T1-D-V1 | 4.5 W | Supported |

| CPM1A Expansion I/O Unit | Power consumption |
|--------------------------|-------------------|
| CPM1A-20EDR1 | 2.5 W |
| CPM1A-20EDT/T1 | 1.5 W |
| CPM1A-8ED | 1 W |
| CPM1A-8ER | 2 W |
| CPM1A-8ET/T1 | 1 W |
| CPM1A-SRT21/DRT21 | 1 W |
| CPM1A-MAD01/MAD11 | 3.5 W |
| CPM1A-TS001/TS101 | 3 W |
| CPM1A-TS002/TS102 | 3 W |

Note: The power consumption for CPU Units includes the power consumption of Programming Consoles and Units such as RS-232C Adapters

Specifications

■ Performance Specifications

| Item | | 10-point I/O | 20-point I/O | 30-point I/O | 40-point I/O |
|--|-------------------------|--|---|---------------------------------------|--|
| Control method | | Stored program method | | | |
| I/O control method | | Combination of the cyclic scan and immediate refresh processing methods. | | | |
| Programming language | | Ladder diagram | | | |
| Instruction word | | 1 step per instruction, 1 to 5 words per instruction | | | |
| Types of instructions | Basic instructions | 14 types | | | |
| | Special instructions | 79 types, 139 instructions | | | |
| Instruction execution time | Basic instructions | 0.72 to 16.2 μ s | | | |
| | Special instructions | MOV instruction = 16.3 μ s | | | |
| Program capacity | | 2,048 words | | | |
| Maximum I/O points | CPU only | 10 points (6 input/4 output points) | 20 points (12 input/8 output points) | 30 points (18 input/12 output points) | 40 points (24 input/16 output points) |
| | With Expansion I/O Unit | --- | --- | 90 points (54 input/36 output points) | 100 points (60 input/40 output points) |
| Input bits | | 00000 to 00915 (Words 0 to 9) | | | |
| Output bits | | 01000 to 01915 (Words 10 to 19) | | | |
| Work bits (IR Area) | | 512: IR 20000 to IR 23115 (IR 200 to IR 231) | | | |
| Special bits (SR Area) | | 384: SR 23200 to SR 25515 (SR 232 to SR 255) | | | |
| Temporary bits (TR Area) | | 8: TR 0 to TR 7 | | | |
| Holding bits (HR Area) | | 320: HR 0000 to HR 1915 (HR 00 to HR 19) | | | |
| Auxiliary bits (AR Area) | | 256: AR 0000 to AR 1515 (AR 00 to AR 15) | | | |
| Link bits (LR Area) | | 256: LR 0000 to LR 1515 (LR 00 to LR 15) | | | |
| Timers/Counters | | 128: TIM/CNT 000 to 127 100-ms timer: TIM 000 to TIM 127 10-ms timer: TIM 000 to TIM 127 Decremental counter, reversible counter | | | |
| Data memory | Read/Write | 1,024 words (DM 0000 to DM 1023) | | | |
| | Read only | 512 words (DM 6144 to DM 6655) | | | |
| Interrupt processing: External interrupt | | 2 points (Response time of 0.3 ms max.) | 4 points (Response time of 0.3 ms max.) | | |
| Memory protection | | Maintains the contents of the HR, AR, Counter and Data Memory Areas. | | | |
| Memory backup | | Flash memory: User program, data memory (Read only) (Non-battery powered storage) Super capacitor: Data memory (Read/Write), holding bits, auxiliary memory bits, counter (20-day storage at an ambient temperature of 25°C) | | | |
| Self-diagnostic function | | CPU error (watchdog timer), memory errors, I/O bus errors | | | |
| Program check | | No END instruction programming errors (constantly checked during operation) | | | |
| Pulse output | | 1 point: 2 kHz | | | |
| High-speed counter | | 1 point: Single phase at 5 kHz or two-phase at 2.5 kHz (linear counting method) Incremental mode: 0 to 65535 (16-bit) Decremental mode: -32767 to 32767 (16-bit) 1 point: Single phase at 5 kHz or two-phase at 2.5 kHz (linear counting method) Incremental mode: 0 to 65535 (16-bit) Decremental mode: -32767 to 32767 (16-bit) | | | |
| Quick-response inputs | | Together with the external interrupt input (minimum pulse width of 0.2 ms) | | | |
| Input time constant | | Can be set at 1 ms, 2 ms, 4 ms, 8 ms, 16 ms, 32 ms, 64 ms, or 128 ms. | | | |
| Analog settings | | 2 points: (0 to 200) | | | |

Note: Bits that are not used for the I/O bits can be used as work bits.

Specifications

■ I/O Specifications

Input Circuit

CPU

| Item | Specifications | Circuit |
|-------------------------|--|---------|
| Input voltage | 24 VDC +10%/−15% | |
| Input impedance | IN00000 to IN00002: 2 kΩ Others: 4.7 kΩ | |
| Input current (typical) | IN00000 to IN00002: 12 mA Others: 5 mA | |
| ON voltage | 14.4 VDC min. | |
| OFF voltage | 5.0 VDC max. | |
| ON delay (see note 1) | 1 to 128 ms max. (default: 8 ms) (see note 1) | |
| OFF delay (see note 1) | 1 to 128 ms max. (default: 8 ms) (see note 1) | |

Note The polarity of the input power supply can be either positive or negative.
Resistance values in parentheses are for inputs IN00000 to IN00002.

Note: 1. The actual ON/OFF delay includes an input constant of 1, 2, 4, 8, 16, 32, 64, or 128 ms (default: 8 ms).

2. The delays for IN00000 to IN00002 are as follows when used for the high-speed counter.

| Input | Increment mode | Differential phase mode |
|-------------------|----------------------------------|-------------------------|
| IN00000 (A-phase) | 5 kHz | 2.5 kHz |
| IN00001 (B-phase) | Normal input | |
| IN00002 (Z-phase) | ON: 100 μs max. OFF: 500 μs max. | |

3. The delays for IN00003 to IN00006 are as follows when used for the high-speed counter.

| | |
|-------|---|
| Delay | 0.3 ms max. (From the time of input ON until the interrupt subroutine is executed.) |
|-------|---|

Expansion I/O Unit

| Item | Specifications | Circuit |
|-------------------------|--|---------|
| Input voltage | 24 VDC, +10%/−15% | |
| Input impedance | 4.7 kΩ | |
| Input current (typical) | 5 mA | |
| ON voltage | 14.4 VDC min. | |
| OFF voltage | 5.0 VDC max. | |
| ON delay | 1 to 128 ms max. (default: 8 ms) (see note) | |
| OFF delay | 1 to 128 ms max. (default: 8 ms) (see note) | |

Note The polarity of the input power supply can be either positive or negative.

Note: The actual ON/OFF delay includes an input constant of 1, 2, 4, 8, 16, 32, 64, or 128 ms (default: 8 ms).

Specifications

Output Circuit

CPU and Expansion I/O Unit

Relay Output

| Item | | Specifications | Circuit | |
|----------------------------|------------|---|---------|---|
| Maximum switching capacity | | 250 VAC/2 A (cos $\phi = 1$) 24 VDC/2 A (4 A/common) | | |
| Minimum switching capacity | | 5 VDC, 10 mA | | |
| Relay service life | Electrical | Resistance load | | 150,000 times (at 24 VDC) |
| | | Inductive load | | 100,000 times (at 220 VAC, cos $\phi=0.4$) |
| | Mechanical | | | 20 million times |
| ON delay | | 15 ms max. | | |
| OFF delay | | 15 ms max. | | |

Transistor Output (Sink Type/Source Type) (CPU/Expansion I/O Unit)

| Item | | Specifications | Circuit |
|----------------------------|--|---|---------|
| Maximum switching capacity | | 24 VDC $+10\%/-15\%$, 300 mA (see note 1) | |
| Leakage current | | 0.1 mA max. | |
| Residual voltage | | 1.5 V max. | |
| ON delay | | 0.1 ms max. | |
| OFF delay | | 1 ms max. (see note 2) | |

Note: 1. The maximum switching capacity of the CPM1A with transistor outputs (sink type and source type) are limited to the currents shown in the following table for the common and for the Unit.

| Item | 10CDT-V1/ 10CDT1-A-V1/D-V1 | 20CDT-D-V1/ 20CDT1-A-V1/D-V1 | 30CDT-D-V1/ 30CDT1-A-V1/D-V1 | 40CDT-D-V1/ 40CDT1-A-V1/D-V1 | 20EDT/ 20EDT1 | CPM1A-8ET/ 8ET1 |
|-------------------------|-------------------------------|---------------------------------|---------------------------------|---------------------------------|----------------------------|--------------------|
| Max. switching capacity | 0.9 A/Unit | 0.9 A/common 1.8 A/Unit | 0.9 A/common 2.7 A/Unit | 0.9 A/common 3.6 A/Unit | 0.9 A/common 1.8 A/Unit | |

2. When using the pulse output function of the CPM1A with transistor outputs (sink type and source type):
The output current must be within a range from 100 to 200 mA when using the output 01000 or 01001 as a pulse output with the maximum frequency of 2 kHz. The outputs 01000 and 01001 will vary depending on the output current.

| Load current | OFF delay |
|--|-------------|
| 100 to 200 mA | 0.2 ms max. |
| 0 to 300 mA except for the above range | 0.5 ms max. |

Specifications

■ Analog I/O Unit

| | | CPM1A-MAD01 | | CPM1A-MAD11 | |
|---------------------------------|--|---|--|--|--------------------------------|
| | | Voltage I/O | Current I/O | Voltage I/O | Current I/O |
| Analog inputs | Number of inputs | 2 | | 2 (2 words allocated) | |
| | Input signal range | 0 to 10 V/1 to 5 V | 4 to 20 mA | 0 to 5 V/1 to 5 V/0 to 10 V/-10 to 10 V | 0 to 20 mA/ 4 to 20 mA |
| | Maximum rated input | ±15 V | ±30 mA | ±15 V | ±30 mA |
| | External input impedance | 1 MΩ min. | 250 Ω rated | 1 MΩ min. | 250 Ω |
| | Resolution | 1/256 | | 1/6,000 (full scale) | |
| | Overall precision | 1.0% of full scale | | 25°C: ±0.3% of full scale | 25°C: ±0.4% of full scale |
| | | | | 0 to 55°C: ±0.6% of full scale | 0 to 55°C: ±0.8% of full scale |
| Converted A/D data | 8-bit binary | | Binary data (hexadecimal, 4 digits) -10 to 10 V input range: Full scale = F448 to 0BB8 Hex Other input ranges: Full scale = 0000 to 1770 Hex | | |
| Analog outputs (See note 2.) | Averaging | --- | | Supported (Set for each input using a DIP switch.) | |
| | Disconnection detection | --- | | Supported | |
| | Number of outputs | 1 | | 1 (1 word allocated) | |
| | Output signal range | 0 to 10 V/ -10 to 10 V | 4 to 20 mA | 1 to 5 V/0 to 10 V/ -10 to 10 V | 0 to 20 mA/ 4 to 20 mA |
| | External output max. current | 5 mA | --- | --- | --- |
| | External output allowed load resistance | --- | 350 Ω | 1 kΩ min. | 600 Ω max. |
| | External output impedance | --- | | 0.5 Ω max. | --- |
| | Resolution | 1/256 (1/512 for output signal range -10 to 10 V) | | 1/6,000 (full scale) | |
| | Overall precision | 1.0% of full scale | | 25°C: ±0.4% of full scale | |
| | | | | 0 to 55°C: ±0.8% of full scale | |
| Data setting | 8-bit binary with sign bit | | --- | | |
| Set D/A data | --- | | Binary data (hexadecimal, 4 digits) -10 to 10 V input range: Full scale = F448 to 0BB8 Hex Other input ranges: Full scale = 0000 to 1770 Hex | | |
| Conversion time | 10 ms/Unit max. (See note 1.) | | 2 ms/point (6 ms for all points) | | |
| Isolation method | Photocoupler isolation between I/O terminals and PLC (There is no isolation between the analog I/O signals.) | | Photocoupler isolation between analog I/O and internal circuits (There is no isolation between the analog I/O signals.) | | |

Note 1. The conversion time is the total time for 2 analog inputs and 1 analog output.

2. The voltage output and current output can be used at the same time, but the total output current cannot exceed 21 mA.

■ CompoBus/S I/O Link Unit

Specifications

| Item | Specification |
|--|---|
| Model number | CPM1A-SRT21 |
| Master/Slave | CompoBus/S Slave |
| Number of I/O bits | 8 input bits, 8 output bits |
| Number of words occupied in CPM1A I/O memory | 1 input word, 1 output word (Allocated in the same way as other Expansion Units) |
| Node number setting | Set using the DIP switch. |

Note: See the *CompoBus/S Catalog (Q103)* for more details on CompoBus/S communications.

Specifications

■ CPM1A-DRT21 DeviceNet I/O Link Unit

By connecting the DeviceNet I/O Link Unit (CPM1A-DRT21), the CPM2A can function as the slave of a DeviceNet D Master Unit. In this configuration, I/O links for up to 32 inputs and 32 outputs can be created.

Specifications

| Item | Specification |
|---|---|
| Master/slave | DeviceNet slave |
| Model number | CPM1A-DRT21 |
| Number of I/O points between Unit and Master | Input: 32 points Output: 32 points |
| Number of words allocated from CPM2A's I/O memory | Input: 2 words Output: 2 words (Allocated in the same way as other Expansion Units.) |
| Node address setting method | Set using DIP switch. |
| Maximum number of connectable nodes | 63 (CS1) 32 (CVM1/CV) 25 (C200HX/HG/HE) 16 (C200HS) (The series names in parentheses are for the CPU Unit to which the Master Unit is mounted.) |

■ Temperature Sensor Units

By mounting a Temperature Sensor Unit (CPM1A-TS001/TS002/TS101/TS102) to the PC, input can be obtained from a thermocouple or platinum resistance thermometer, and temperature measurements can be converted to binary data (4-digit hexadecimal) and stored in the input area of the CPU Unit. For details on the maximum number of connectable Units, refer to 7.

Specifications

| Item | Specification | |
|----------------------------|---|---|
| Model number | CPM1A-TS001/002 | CPM1A-TS101/102 |
| Number of inputs | 2 (TS001), 4 (TS002) | 2 (TS101), 4 (TS102) |
| Input types | K, J switchable (Note: Same input for all input points.) | Pt100, JPt100 switchable (Note: Same input for all input points.) |
| Indication accuracy | [The larger of the indicated value $\pm 0.5\%$ and $\pm 2^\circ\text{C}$] ± 1 digit max. | [The larger of the indicated value $\pm 0.5\%$ and $\pm 1^\circ\text{C}$] ± 1 digit max. |
| Conversion time | 250 ms/2 points (TS001, TS101); 250 ms/4 points (TS002, TS102) | |
| Converted temperature data | Binary (4-digit hexadecimal) | |
| Isolation method | Photocoupler isolation between the temperature input signals. | |

Note: The indication accuracy when using a K-type thermocouple for temperatures less than -100°C is $\pm 4^\circ\text{C} \pm 1$ digit max.

Input Temperature Ranges for CPM1A-TS001/002

The rotary switch can be used to make of the following range and input type settings for CPM1A-TS001/002 models.

| Input type | Range ($^\circ\text{C}$) | | Range ($^\circ\text{F}$) |
|------------|----------------------------|--|----------------------------|
| K | -200 to 1300 | | -300 to 2300 |
| | 0.0 to 500.0 | | 0.0 to 900.0 |
| J | -100 to 850 | | -100 to 1500 |
| | 0.0 to 400.0 | | 0.0 to 750.0 |

Input Temperature Ranges for CPM1A-TS101/102

The rotary switch can be used to make of the following range and input type settings for CPM1A-TS101/102 models.

| Input type | Range ($^\circ\text{C}$) | | Range ($^\circ\text{F}$) |
|------------|----------------------------|--|----------------------------|
| Pt100 | -200.0 to 650.0 | | -300 to 1200.0 |
| JPt100 | -200.0 to 650.0 | | -300 to 1200.0 |

Specifications

■ Communications Adapter Specifications CPM1-CIF01/CIF11

RS-232C Adapter and RS-422 Adapter

| Item | Specifications | |
|---------------------------------|---|--|
| | CPM1-CIF01 | CPM1-CIF11 |
| Functions | Level conversion between the CMOS level (CPU side) and the RS-232C (peripheral device side) | Level conversion between the CMOS level (CPU side) and the RS-422 (peripheral device side) |
| Insulation | The RS-232C (peripheral device side) is insulated by a DC/DC converter and photocoupler. | The RS-422 (peripheral device side) is insulated by a DC/DC converter and photocoupler. |
| Power supply | Power is supplied by the CPU. | |
| Power consumption | 0.3 A max. | |
| Transmission speed | 38.4 Kbits/s max. | |
| Vibration resistance | 10 to 57 Hz with an amplitude of 0.075 mm, and 57 to 150 Hz with an acceleration of 9.8 m/s ² in the X, Y and Z directions for 80 minutes each in accordance (i.e. swept for 8 minutes, 10 times). | |
| Shock resistance | 147 m/s ² in the X, Y and Z directions 3 times each. | |
| Ambient temperature (operating) | 0° to 55°C | |
| Ambient humidity (operating) | 10% to 90% (with no condensation) | |
| Ambient environment (operating) | With no corrosive gas | |
| Ambient temperature (storage) | -20° to 75°C | |
| Weight | 200 g max. | |

■ Memory Backup

The user program and memory area data in the CPU Unit are backed up by either one of the following methods.

- Flash Memory:
User program, read-only DM area (DM 6144 to DM 6599), and PC Setup area (DM 6600 to DM 6655).
- Internal Capacitor:
DM areas other than the above, HR area, AR area, and Counter area.

The capacitor provides backup for a power interruption lasting 20 days at room temperature. If the power is expected to remain OFF for a period exceeding this data backup period, consideration must be given to the design of the system so that no problems will occur when the set values become undefined ones. For further details, refer to *CPM1A Operation Manual (W317)*.

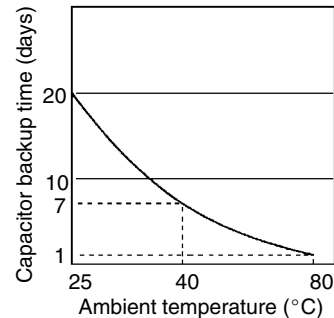

Specifications

■ CPM2C-PA201 AC Power Supply Unit

The CPM2C-PA201 is a compact, streamlined Unit that can be used as the power supply for PCs, such as the CPM1A and CPM2A, and indicators. (When using the CPM2C-PA201, connection must be performed by the user.)

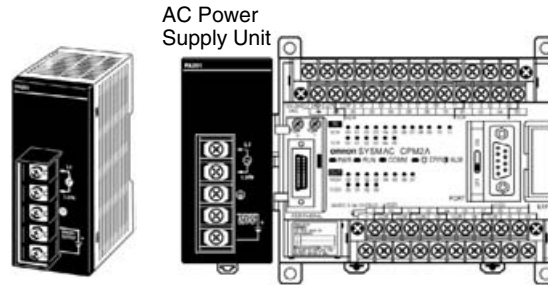

Specifications

| Item | | Specification | |
|-------------------------------|---|---|-------------------------------|
| Rated output | | 15 W | |
| Output voltage | | 24 VDC | |
| Output current | | 600 mA | |
| Efficiency | | 75% min. (at rated output) | |
| Input conditions | Rated voltage | 100 to 240 VAC | |
| | Allowable voltage range | 85 to 264 VAC | |
| | Frequency | 47 to 63 Hz | |
| | Current | 100 V | 0.4 A |
| | | 200 V | 0.2 A |
| | Leakage current | 100 V | 0.5 mA max. (at rated output) |
| | | 200 V | 1 mA max. (at rated output) |
| Inrush current | 100 V | 15 A (at 25°C cold start) | |
| | 200 V | 30 A (at 25°C cold start) | |
| Output characteristics | Output voltage accuracy | 5%/–10% max.; 10%/–15% max. (including input, load, and temperature fluctuations) | |
| | Minimum output current | 30 mA | |
| | Ripple noise voltage | 2% (p-p) max. | |
| | Input fluctuation | 0.75% max. | |
| | Load fluctuation | 4% max. | |
| | Temperature fluctuation | 0.05%/°C max. | |
| | Startup time | 300 ms max. (at input voltage of 100 VAC or 200 VAC and the rated output) | |
| Output hold time | 10 ms (at input voltage of 100 VAC or 200 VAC and the rated output) | | |
| Overcurrent protection | | Self-resetting, operates at 105% to 335% of the rated current, suspended and intermittent operation | |
| Overvoltage protection | | None | |
| Ambient operating temperature | | 0 to 55°C | |
| Ambient storage temperature | | –20 to 70°C (no condensation or icing) | |
| Ambient operating humidity | | 10% to 90% | |
| Dielectric strength | | 2,000 V for 1 min between all inputs and GR Detection current: 10 mA 3,000 V for 1 min between all inputs and all outputs Detection current: 10 mA 1,000 V for 1 min between all outputs and GR Detection current: 10 mA | |
| Insulation resistance | | 100 MΩ min. at 500 VDC between all outputs and any input, and between all outputs and GR | |
| Vibration resistance | | 10 to 57 Hz, double amplitude of 0.075 mm, 57 to 150 Hz, acceleration: 9.8 m/s ² in X, Y, and Z directions for 80 minutes according (Time coefficient: 8 minutes × coefficient factor 10 = total time 80 min.) | |
| Shock resistance | | 147 m/s ² 3 times each in X, Y, and Z directions | |
| Noise terminal voltage | | FCC class A | |
| Weight | | 250 g max. | |
| External dimensions | | 40 × 65 × 90 mm (W × H × D) | |

Functions

■ Input Interrupts

There are two input interrupts in the CPM1A 10-point I/O CPU and four in the 20-, 30-, and 40-point I/O CPUs. Input interrupts are available in two modes.

10-point I/O CPU

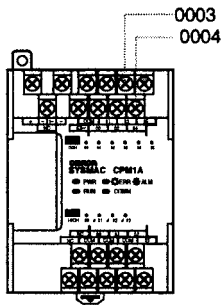

20-, 30-, and 40-point I/O CPU

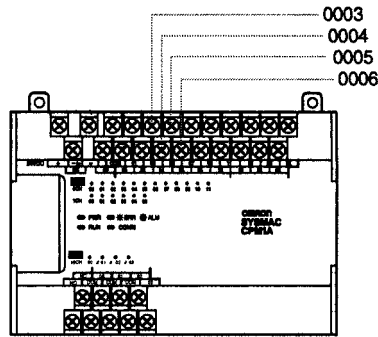

Application Example:

Cutting Metal Sheets to Specified Lengths

The proximity sensor detects the edge of a metal plate to operate the cutter. Metal sheets can be cut continuously to the specified lengths at a high speed.

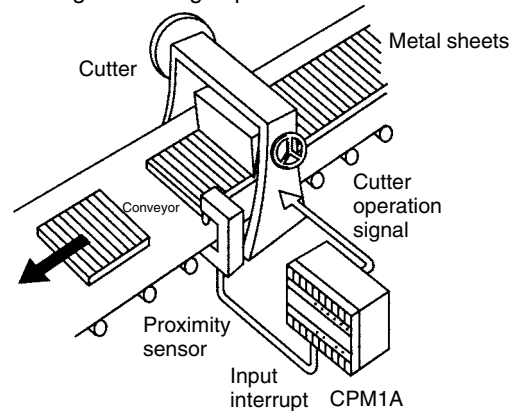

Input Interrupt Mode

If an input interrupt occurs, the regular program shuts down irrelevant of the cycle time, and the interrupt processing program is executed immediately.

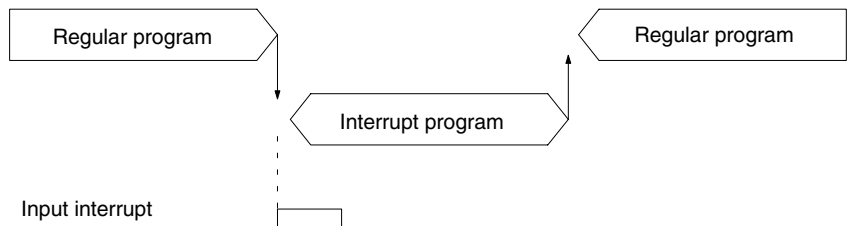

Counter Mode

When the number of external signals counted at high speed reaches a specified number of counts, the regular program shuts down, and the interrupt processing program is executed at fixed counts. The count can be set between 0 and 65535.

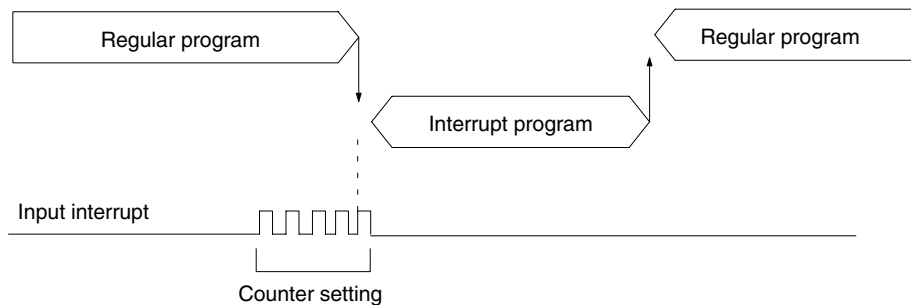

■ Quick-response Inputs

There are two quick-response inputs for the CPM1A 10-point I/O CPU and four for the 20-, 30-, and 40-point I/O CPU (shared with the interrupt inputs). Since an internal buffer is provided, the quick-response input function can even detect signals modified within one cycle.

| CPU | Input no. | Minimum input pulse width |
|--------------------------------------|----------------|---------------------------|
| 10-point I/O CPU | 00003 to 00004 | 0.2 ms |
| 20-point, 30-point, 40-point I/O CPU | 00003 to 00006 | |

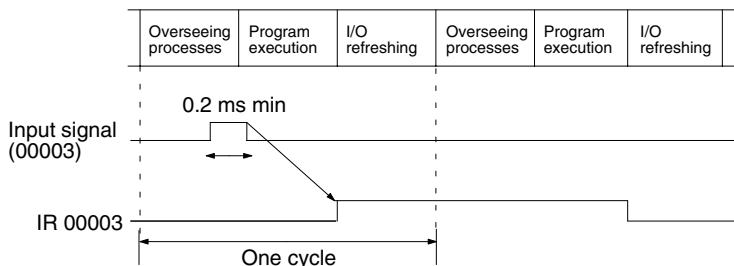

Application Example:

Calculating the Number of Chips

The metal sensor counts the number of parts that have passed. Steady counting can be achieved even when the input-ON time is short.

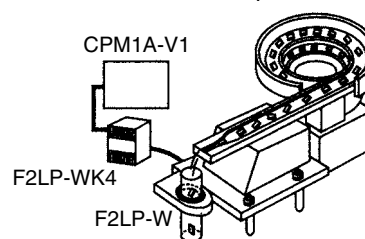

■ High-speed Counter

The CPM1A has a high-speed counter function that can be used in the incrementing and up/down mode. Using this function together with the input interrupts enables zone comparison control or target value control irrelevant of the cycle time.

| Item | Incrementing mode | Up/Down mode |
|-----------------|--------------------|-----------------------------|
| Input no. | 00000 | Count input |
| | 00001 | --- |
| | 00002 | Reset input |
| Input method | Single-phase input | Phase-difference, 4× inputs |
| Count frequency | 5.0 kHz | 2.5 kHz |
| Count range | 0 to 65535 | -32767 to 32767 |

Note: When using in the incrementing mode, the input 00001 can be used as an input contact.

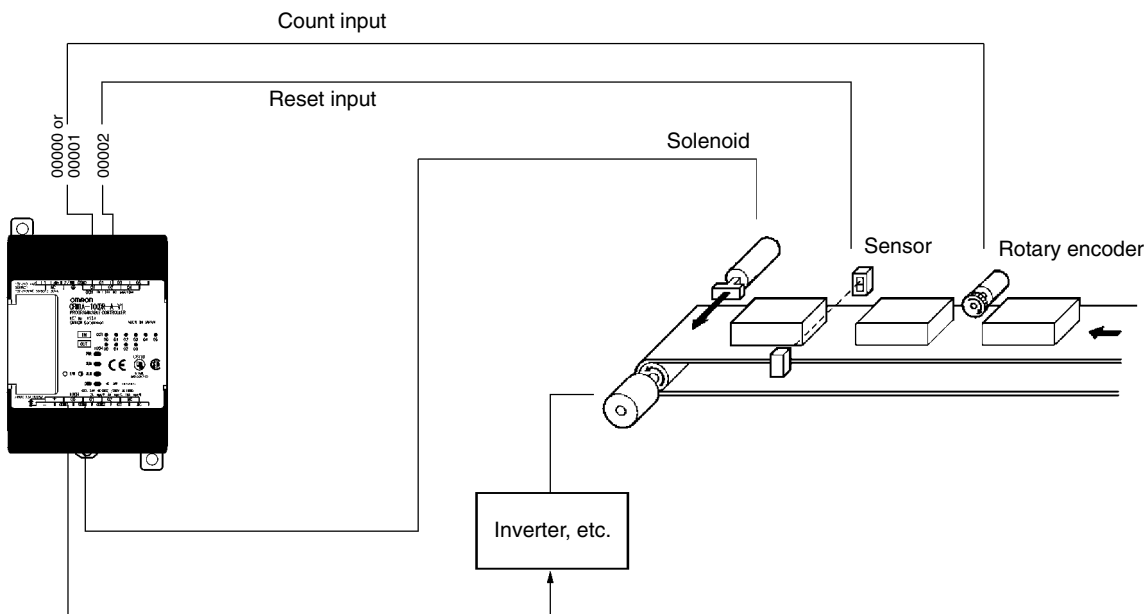

Functions

■ Interval Timer Interrupts

The CPM1A has one interval timer. The interval timer shuts down the regular program irrelevant of the point in the cycle once the time is up, and immediately executes an interrupt processing program. Interval timers are used in the following two modes.

| Item | One-shot mode | Scheduled interrupt mode |
|--------------|---|--|
| Operation | An interrupt is executed only once when the time is up. | Interrupts are executed repeatedly at fixed periods. |
| Setting time | 0.5 ms to 319,968 ms (0.1-ms units) | |

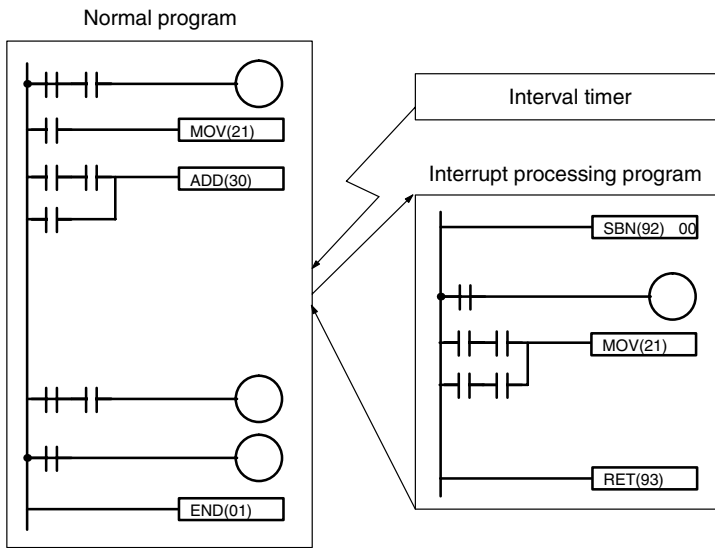

Application Example:

Computing the Sheet Speed

The number of pulse inputs is computed in the interrupt mode at a fixed time to calculate the speed.

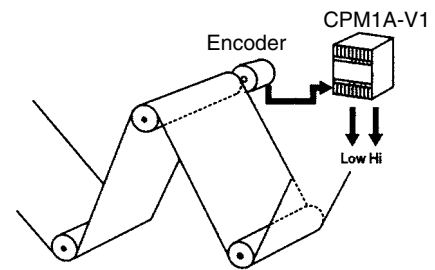

■ Analog Setting

The CPM1A contains two analog setting controls that can be used for a broad range of analog timer and counter settings. Turning the setting control stores values of 0 to 200 (BCD data) in the SR area.

| Analog setting | Storage area | Setting value (BCD) |
|------------------|--------------|---------------------|
| Analog setting 0 | SR 250 | 0000 to 0200 |
| Analog setting 1 | SR 251 | |

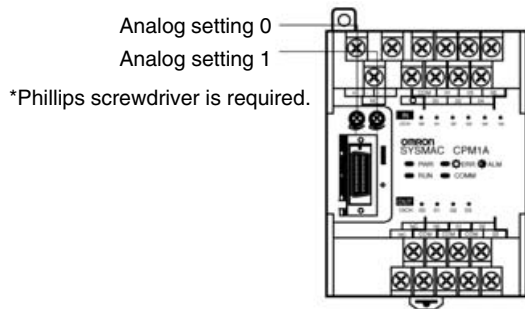

Application Example:

Tact Operation Control of Conveyor Lines

A conveyor can be stopped temporarily as required for assembly processes. When the timer function and limit switches are used in a combination, conveyors can be stopped for a fixed time or can be run at a constant speed for a fixed distance. Fine adjustment of the stopping time can be easily done by using the analog setting controls.

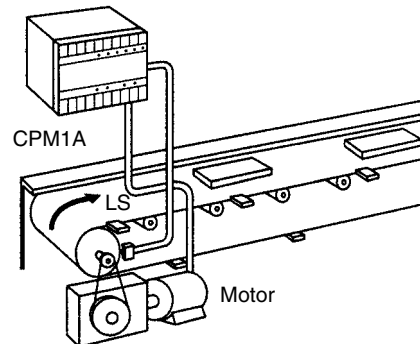

Program Example

1. Analog timer for 0.0 to 20.0 seconds

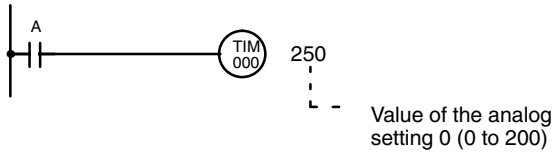

2. Analog timer for 0.0 to 60.0 seconds

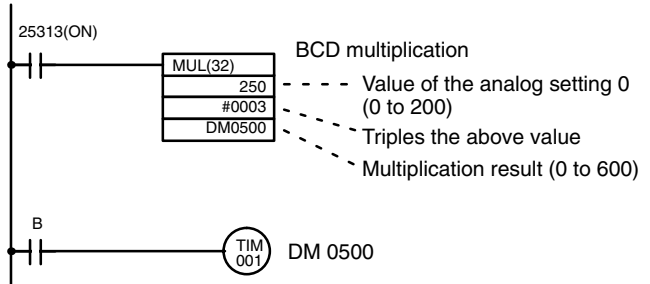

■ Pulse Output Function

The CPM1A with transistor output has a function that is capable of outputting a pulse of up to 2 kHz.

When used in combination with a Stepping Driver or Servodriver, positioning can be easily performed.

Application Example

Changing the speed of the Stepping Motor.

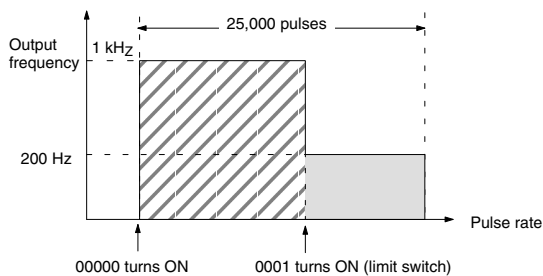
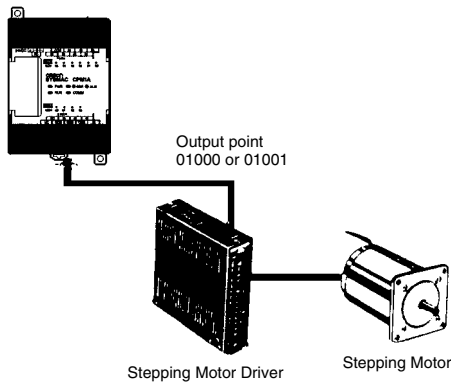

Program Example

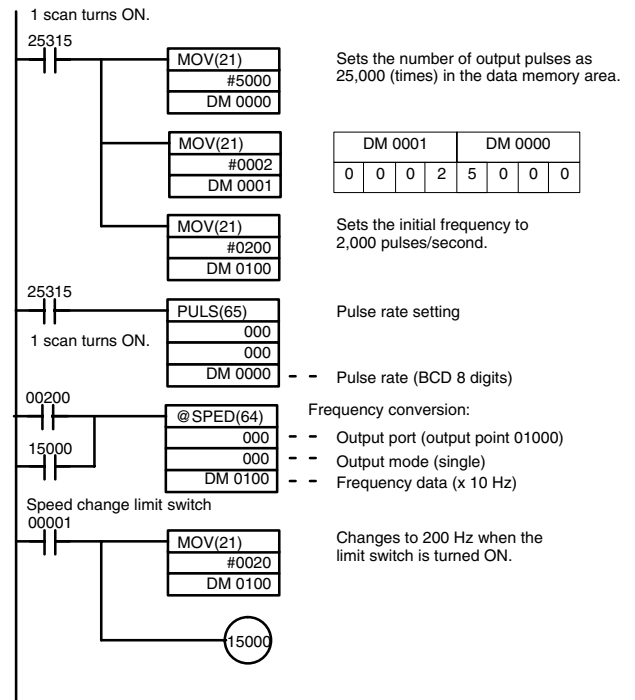

Functions

■ Communications

Host Link Communications

CPM1A host link communications consist of interactive procedures whereby the CPM1A returns a response to a command sent from the IBM PC/AT or compatible computer. These communications allow the IBM PC/AT or compatible computer to read and write in the CPM1A's I/O Areas and Data Memory Areas as well as in areas containing the status of various settings.

1:1 Host Link Communications

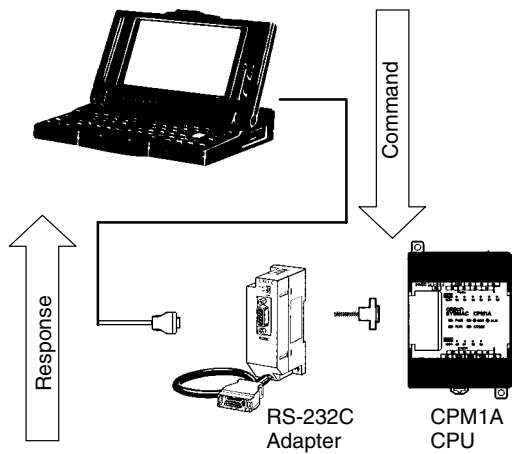

1:n Host Link Communications

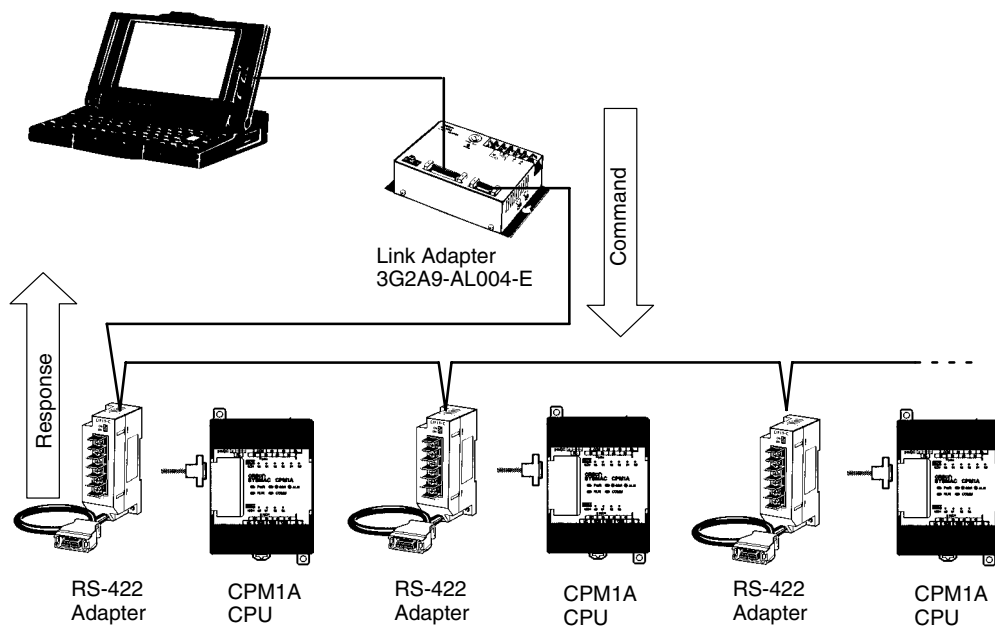

1:1 Links

With a 1:1 link, two CPM1As or a CPM1A and CQM1 or C200H□ are connected 1:1 with one side as the Master and the other as the Slave to provide an I/O link of a maximum of 256 points (LR 0000 to LR 1515).

Example of a 1:1 Link between CPM1As

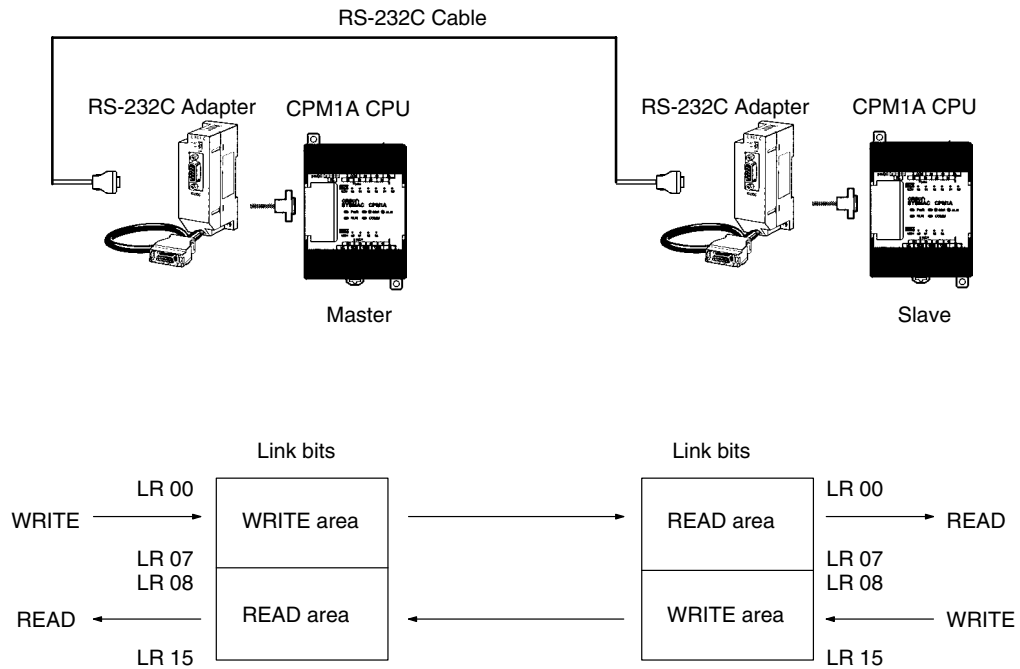

Limitations of the CPM1A 1:1 Link

CPM1A I/O links are limited to 16 words (LR 00 to LR 15). Therefore, use these 16 words (LR 00 to LR 15) on the CQM1 or C200H□ side when forming 1:1 links with a CQM1 or C200H□.

NT Links

High-speed communications can be achieved by providing a direct access through the use of the NT Link between the CPM1A and Programmable Terminal.

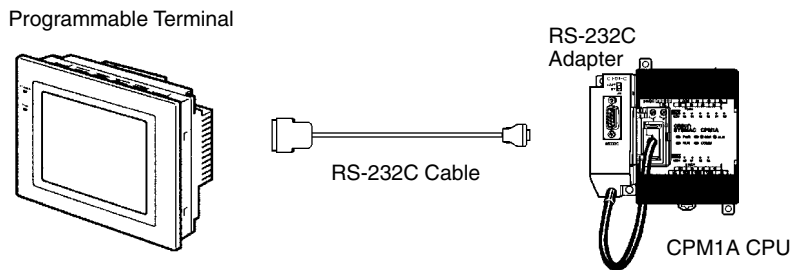

Programming Instructions

Summary of Programming Instructions

■ Function Code Chart

| Table symbols | Details | Key operations for specifying programming instructions |
|---------------|--|--|
| ○ | Allocated to instruction keys on the Programming Console. These need not be specified with function codes. | --- |
| Code | Special instructions specified with function codes. | FUN → Code → WRITE |

■ Differentiated Instructions

Differentiated instructions can sometimes be used for CPM1A special instructions. Instructions marked with (@) in the mnemonics can also be used as differentiated instructions. Here the input rise time (shift from OFF to ON) is used to execute the instruction in just one cycle.

To specify an instruction, press the NOT Key after the function code.

Example: Specifying the @MOV (21) instruction

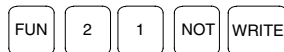

■ Sequence Instructions

Sequence Input Instructions

| Instruction | Mnemonic | Code | Function |
|-------------|----------|------|---|
| LOAD | LD | ○ | Connects an NO condition to the left bus bar. |
| LOAD NOT | LD NOT | ○ | Connects an NC condition to the left bus bar. |
| AND | AND | ○ | Connects an NO condition in series with the previous condition. |
| AND NOT | AND NOT | ○ | Connects an NC condition in series with the previous condition. |
| OR | OR | ○ | Connects an NO condition in parallel with the previous condition. |
| OR NOT | OR NOT | ○ | Connects an NC condition in parallel with the previous condition. |
| AND LOAD | AND LD | ○ | Connects two instruction blocks in series. |
| OR LOAD | OR LD | ○ | Connects two instruction blocks in parallel. |

Note: ○: Instruction keys allocated to the Programming Console.

Sequence Output Instructions

| Instruction | Mnemonic | Code | Function |
|--------------------|----------|------|--|
| OUTPUT | OUT | ○ | Outputs the result of logic to a bit. |
| OUT NOT | OUT NOT | ○ | Reverses and outputs the result of logic to a bit. |
| SET | SET | ○ | Force sets (ON) a bit. |
| RESET | RSET | ○ | Force resets (OFF) a bit. |
| KEEP | KEEP | 11 | Maintains the status of the designated bit. |
| DIFFERENTIATE UP | DIFU | 13 | Turns ON a bit for one cycle when the execution condition goes from OFF to ON. |
| DIFFERENTIATE DOWN | DIFD | 14 | Turns ON a bit for one cycle when the execution condition goes from ON to OFF. |

Note: ○: Instruction keys allocated to the Programming Console.

Sequence Control Instructions

| Instruction | Mnemonic | Code | Function |
|-----------------|----------|------|---|
| NO OPERATION | NOP | 00 | --- |
| END | END | 01 | Required at the end of the program. |
| INTERLOCK | IL | 02 | If the execution condition for IL(02) is OFF, all outputs are turned OFF and all timer PVs reset between IL(02) and the next ILC(03). |
| INTERLOCK CLEAR | ILC | 03 | ILC(03) indicates the end of an interlock (beginning at IL(02)). |
| JUMP | JMP | 04 | If the execution condition for JMP(04) is ON, all instructions between JMP(04) and JME(05) are treated as NOP(00). |
| JUMP END | JME | 05 | JME(05) indicates the end of a jump (beginning at JMP(04)). |

■ Timer/Counter Instructions

| Instruction | Mnemonic | Code | Function |
|--------------------|----------|------|--|
| TIMER | TIM | ○ | An ON-delay (decrementing) timer. |
| COUNTER | CNT | ○ | A decrementing counter. |
| REVERSIBLE COUNTER | CNTR | 12 | Increases or decreases PV by one. |
| HIGH-SPEED TIMER | TIMH | 15 | A high-speed, ON-delay (decrementing) timer. |

Note: ○: Instruction keys allocated to the Programming Console.

Programming Instructions

■ Step Instructions

| Instruction | Mnemonic | Code | Function |
|--------------|----------|------|---|
| STEP DE-FINE | STEP | 08 | Defines the start of a new step and resets the previous step when used with a control bit. Defines the end of step execution when used without a control bit. |
| STEP START | SNXT | 09 | Starts the execution of the step when used with a control bit. |

■ Increment/Decrement Instructions

| Instruction | Mnemonic | Code | Function |
|-------------|----------|------|--|
| INCREMENT | (@)INC | 38 | Increments the BCD content of the specified word by 1. |
| DECREMENT | (@)DEC | 39 | Decrements the BCD content of the specified word by 1. |

■ BCD/Binary Calculation Instructions

| Instruction | Mnemonic | Code | Function |
|---------------------|----------|------|--|
| BCD ADD | (@)ADD | 30 | Adds the content of a word (or a constant). |
| BCD SUBTRACT | (@)SUB | 31 | Subtracts the content of a word (or constant) and CY from the content of a word (or constant). |
| BCD MULTIPLY | (@)MUL | 32 | Multiplies the contents of two words (or constants). |
| BCD DIVIDE | (@)DIV | 33 | Divides the content of a word (or constant) by the content of a word (or constant). |
| BINARY ADD | (@)ADB | 50 | Adds the contents of two words (or constants) and CY. |
| BINARY SUBTRACT | (@)SBB | 51 | Subtracts the content of a word (or constant) and CY from the content of a word (or constant). |
| BINARY MULTIPLY | (@)MLB | 52 | Multiplies the contents of two words (or constants). |
| BINARY DIVIDE | (@)DVB | 53 | Divides the content of a word (or constant) by the content of a word and obtains the result and remainder. |
| DOUBLE BCD ADD | (@)ADDL | 54 | Add the 8-digit BCD contents of two pairs of words (or constants) and CY. |
| DOUBLE BCD SUBTRACT | (@)SUBL | 55 | Subtracts the 8-digit BCD contents of a pair of words (or constants) and CY from the 8-digit BCD contents of a pair of words (or constants). |
| DOUBLE BCD MULTIPLY | (@)MULL | 56 | Multiplies the 8-digit BCD contents of two pairs of words (or constants). |
| DOUBLE BCD DIVIDE | (@)DIVL | 57 | Divides the 8-digit BCD contents of a pair of words (or constants) by the 8-digit BCD contents of a pair of words (or constants). |

■ Data Conversion Instructions

| Instruction | Mnemonic | Code | Function |
|--------------------|----------|------|--|
| BCD TO BINARY | (@)BIN | 23 | Converts 4-digit BCD data to 4-digit binary data. |
| BINARY TO BCD | (@)BCD | 24 | Converts 4-digit binary data to 4-digit BCD data. |
| 4 TO 16 DECODER | (@)MLPX | 76 | Takes the hexadecimal value of the specified digit(s) in a word and turns ON the corresponding bit in a word(s). |
| 16 TO 4 DECODER | (@)DMPX | 77 | Identifies the highest ON bit in the specified word(s) and moves the hexadecimal value(s) corresponding to its location to the specified digit(s) in a word. |
| ASCII CODE CONVERT | (@)ASC | 86 | Converts the designated digit(s) of a word into the equivalent 8-bit ASCII code. |

Data Comparison Instructions

| Instruction | Mnemonic | Code | Function |
|----------------|----------|------|---|
| COMPARE | CMP | 20 | Compares two four-digit hexadecimal values. |
| DOUBLE COMPARE | CMPL | 60 | Compares two eight-digit hexadecimal values. |
| BLOCK COMPARE | (@)BCMP | 68 | Judges whether the value of a word is within 16 ranges (defined by lower and upper limits). |
| TABLE COMPARE | (@)TCMP | 85 | Compares the value of a word to 16 consecutive words. |

Programming Instructions

■ Data Movement Instructions

| Instruction | Mnemonic | Code | Function |
|------------------------|----------|------|---|
| MOVE | (@)MOV | 21 | Copies a constant or the content of a word to a word. |
| MOVE NOT | (@)MVN | 22 | Copies the complement of a constant or the content of a word to a word. |
| BLOCK TRANSFER | (@)XFER | 70 | Copies the content of a block of up to 1,000 consecutive words to a block of consecutive words. |
| BLOCK SET | (@)BSET | 71 | Copies the content of a word to a block of consecutive words. |
| DATA EXCHANGE | (@)XCHG | 73 | Exchanges the content of two words. |
| SINGLE WORD DISTRIBUTE | (@)DIST | 80 | Copies the content of a word to a word (whose address is determined by adding an offset to a word address). |
| DATA COLLECT | (@)COLL | 81 | Copies the content of a word (whose address is determined by adding an offset to a word address) to a word. |
| MOVE BIT | (@)MOVB | 82 | Copies the specified bit from one word to the specified bit of a word. |
| MOVE DIGIT | (@)MOVD | 83 | Copies the specified digits (4-bit units) from a word to the specified digits of a word. |

■ Logic Instructions

| Instruction | Mnemonic | Code | Function |
|---------------|----------|------|--|
| COMPLEMENT | (@)COM | 29 | Turns OFF all ON bits and turns ON all OFF bits in the specified word. |
| LOGICAL AND | (@)ANDW | 34 | Logically ANDs the corresponding bits of two words (or constants). |
| LOGICAL OR | (@)ORW | 35 | Logically ORs the corresponding bits of two words (or constants). |
| EXCLUSIVE OR | (@)XORW | 36 | Exclusively ORs the corresponding bits of two words (or constants). |
| EXCLUSIVE NOR | (@)XNRW | 37 | Exclusively NORs the corresponding bits of two words (or constants). |

■ Shift Instructions

| Instruction | Mnemonic | Code | Function |
|-----------------------------|----------|------|--|
| SHIFT REGISTER | SFT | ○/10 | Copies the specified bit (0 or 1) into the rightmost bit of a shift register and shifts the other bits one bit to the left. |
| WORD SHIFT | (@)WSFT | 16 | Creates a multiple-word shift register that shifts data to the left in one-word units. |
| ASYNCHRONOUS SHIFT REGISTER | (@)ASFT | 17 | Creates a shift register that exchanges the contents of adjacent words when one is zero and the other is not. |
| ARITHMETIC SHIFT LEFT | (@)ASL | 25 | Shifts a 0 into bit 00 of the specified word and shifts the other bits one bit to the left. |
| ARITHMETIC SHIFT RIGHT | (@)ASR | 26 | Shifts a 0 into bit 15 of the specified word and shifts the other bits one bit to the right. |
| ROTATE LEFT | (@)ROL | 27 | Moves the content of CY into bit 00 of the specified word, shifts the other bits one bit to the left, and moves bit 15 to CY. |
| ROTATE RIGHT | (@)ROR | 28 | Moves the content of CY into bit 15 of the specified word, shifts the other bits one bit to the right, and moves bit 00 to CY. |
| ONE DIGIT SHIFT LEFT | (@)SLD | 74 | Shifts a 0 into the rightmost digit (4-bit unit) of the shift register and shifts the other digits one digit to the left. |
| ONE DIGIT SHIFT RIGHT | (@)SRD | 75 | Shifts a 0 into the leftmost digit (4-bit unit) of the shift register and shifts the other digits one digit to the right. |
| REVERSIBLE SHIFT REGISTER | (@)SFTR | 84 | Creates a single or multiple-word shift register that can shift data to the left or right. |

Note: ○: Instruction keys allocated to the Programming Console.

■ Special Calculation Instruction

| Instruction | Mnemonic | Code | Function |
|-------------|----------|------|--|
| BIT COUNTER | (@)BCNT | 67 | Counts the total number of bits that are ON in the specified block of words. |

Programming Instructions

■ Subroutine Instructions

| Instruction | Mnemonic | Code | Function |
|-------------------|----------|------|--|
| SUBROUTINE ENTRY | (@)SBS | 91 | Executes a subroutine in the main program. |
| SUBROUTINE ENTRY | SBN | 92 | Marks the beginning of a subroutine program. |
| SUBROUTINE RETURN | RET | 93 | Marks the end of a subroutine program. |
| MACRO | MCRO | 99 | Calls and executes the specified subroutine, substituting the specified input and output words for the input and output words in the subroutine. |

■ Interrupt Control Instructions

| Instruction | Mnemonic | Code | Function |
|------------------|----------|------|--|
| INTERVAL TIMER | (@)STIM | 69 | Controls interval timers used to perform scheduled interrupts. |
| INTERUPT CONTROL | (@)INT | 89 | Performs interrupt control, such as masking and unmasking the interrupt bits for I/O interrupts. |

■ Peripheral Device Control Instructions

I/O Unit Instructions

| Instruction | Mnemonic | Code | Function |
|-------------------|----------|------|---|
| 7-SEGMENT DECODER | (@)SDEC | 78 | Converts the designated digit(s) of a word into an 8-bit, 7-segment display code. |
| I/O REFRESH | (@)IORF | 97 | Refreshes the specified I/O word. |

Display Instruction

| Instruction | Mnemonic | Code | Function |
|-------------|----------|------|---|
| MESSAGE | (@)MSG | 46 | Reads up to 8 words of ASCII code (16 characters) from memory and displays the message on the Programming Console or other Peripheral Device. |

High-speed Counter Control Instructions

| Instruction | Mnemonic | Code | Function |
|--------------------|----------|------|---|
| MODE CONTROL | (@)INI | 61 | Starts and stops counter operation, compares and changes counter PVs, and stops pulse output. |
| PV READ | (@)PRV | 62 | Reads counter PVs and status data. |
| COMPARE TABLE LOAD | (@)CTBL | 63 | Compares counter PVs and generates a direct table or starts operation. |

Pulse Output Control Instructions

| Instruction | Mnemonic | Code | Function |
|--------------|----------|------|--|
| SPEED OUTPUT | (@)SPED | 64 | Outputs pulses at the specified frequency. The output frequency can be changed while the pulses are being output. |
| SET PULSES | (@)PULS | 65 | Outputs the specified number of pulses at the specified frequency. The pulse output cannot be stopped until the specified number of pulses have been output. |

■ Damage Diagnosis Instructions

| Instruction | Mnemonic | Code | Function |
|----------------------|----------|------|---|
| FAILURE ALARM | (@)FAL | 06 | Generates a non-fatal error when executed. The Error/Alarm indicator flashes and the CPU continues operating. |
| SEVERE FAILURE ALARM | FALS | 07 | Generates a fatal error when executed. The Error/Alarm indicator lights and the CPU stops operating. |

■ Special System Instructions

| Instruction | Mnemonic | Code | Function |
|-------------|----------|------|-----------------------------|
| SET CARRY | (@)STC | 40 | Sets Carry Flag 25504 to 1. |
| CLEAR CARRY | (@)CLC | 41 | Sets Carry Flag 25504 to 0. |

Peripheral Devices

CPM1A CPU

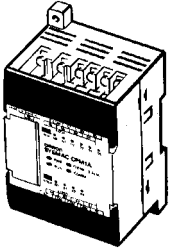

IBM PC/AT or compatible

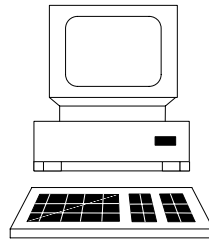

CX-Programmer: WS02-CXPC1-E-V4□
(for Windows 95, 98, Me, NT 4.0, 2000, or XP)

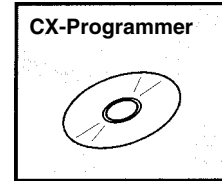

RS-232C USB

USB-Serial Conversion Cable



CS1W-CIF31 *New*

Peripheral Device Connecting Cable

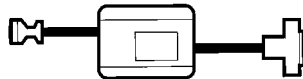

CQM1-CIF02

Programming Console
Connecting Cable



C200H-CN222/CN422
(2 m/4 m)

Programming
Console

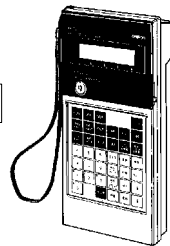

C200H-PRO27-E

Programming Console
(With Connecting Cable)



CQM1-PRO01-E

Standard Models

The abbreviations used in the “Standards” column in the following tables indicate the following international standards.

U: UL, C:CSA, UC: cULus, CU: cUL, N: NK, L: Lloyd, CE: EC Directives





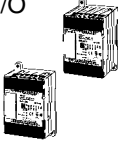
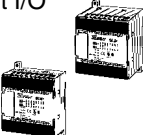
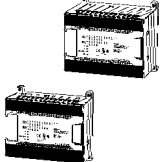
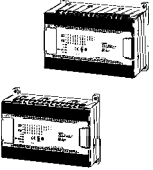



See OMRON sales representatives for conditions under which UL, CSA, cULus, cUL, NK, LLOYD, and CE standards were met.

■ CPU Units

| Name | Power supply | Output method | Input points | Output points | Model | Standards |
|---|-----------------|---------------------------------|--------------|---------------|-------------------|----------------|
| 10-point I/O  | AC power supply | Relay output | 6 points | 4 points | CPM1A-10CDR-A-V1 | U, C, N, L, CE |
| | | Transistor output (sink type) | | | CPM1A-10CDT-A-V1 | U, C, CE |
| | | Transistor output (source type) | | | CPM1A-10CDT1-A-V1 | U, C, CE |
| | DC power supply | Relay output | | | CPM1A-10CDR-D-V1 | U, C, N, L, CE |
| | | Transistor output (sink type) | | | CPM1A-10CDT-D-V1 | U, C, CE, N |
| | | Transistor output (source type) | | | CPM1A-10CDT1-D-V1 | |
| 20-point I/O  | AC power supply | Relay output | 12 points | 8 points | CPM1A-20CDR-A-V1 | U, C, N, L, CE |
| | | Transistor output (sink type) | | | CPM1A-20CDT-A-V1 | U, C, CE |
| | | Transistor output (source type) | | | CPM1A-20CDT1-A-V1 | U, C, CE |
| | DC power supply | Relay output | | | CPM1A-20CDR-D-V1 | U, C, N, L, CE |
| | | Transistor output (sink type) | | | CPM1A-20CDT-D-V1 | U, C, CE, N |
| | | Transistor output (source type) | | | CPM1A-20CDT1-D-V1 | |
| 30-point I/O  | AC power supply | Relay output | 18 points | 12 points | CPM1A-30CDR-A-V1 | U, C, N, L, CE |
| | | Transistor output (sink type) | | | CPM1A-30CDT-A-V1 | U, C, CE |
| | | Transistor output (source type) | | | CPM1A-30CDT1-A-V1 | U, C, CE |
| | DC power supply | Relay output | | | CPM1A-30CDR-D-V1 | U, C, N, L, CE |
| | | Transistor output (sink type) | | | CPM1A-30CDT-D-V1 | U, C, CE, N |
| | | Transistor output (source type) | | | CPM1A-30CDT1-D-V1 | |
| 40-point I/O  | AC power supply | Relay output | 24 points | 16 points | CPM1A-40CDR-A-V1 | U, C, N, L, CE |
| | | Transistor output (sink type) | | | CPM1A-40CDT-A-V1 | U, C, CE |
| | | Transistor output (source type) | | | CPM1A-40CDT1-A-V1 | U, C, CE |
| | DC power supply | Relay output | | | CPM1A-40CDR-D-V1 | U, C, N, L, CE |
| | | Transistor output (sink type) | | | CPM1A-40CDT-D-V1 | U, C, CE, N |
| | | Transistor output (source type) | | | CPM1A-40CDT1-D-V1 | |





Standard Models

■ Expansion I/O Units

| Expansion Unit | Max. number of Units | Output type | Inputs | Outputs | Model | Standards | |
|--------------------------|--------------------------|-----------------------------|--|---------------------------|--|--------------|----------------|
| Expansion I/O Units | 3 Units max. (See note.) | Relay | 12 | 8 |  | CPM1A-20EDR1 | U, C, CE, N |
| | | Transistor (sinking) | | | | CPM1A-20EDT | U, C, CE, N |
| | | Transistor (sourcing) | | | | CPM1A-20EDT1 | U, C, CE, N |
| | | --- | 8 | --- |  | CPM1A-8ED | U, C, CE, N |
| | | Relay | --- | 8 |  | CPM1A-8ER | U, C, CE, N |
| | | Transistor (sinking) | --- | 8 |  | CPM1A-8ET | U, C, CE, N |
| | | Transistor (sourcing) | --- | 8 |  | CPM1A-8ET1 | U, C, L, CE, N |
| Analog I/O Unit | 3 Units max. (See note.) | Analog (resolution: 1/256) | 2 | 1 |  | CPM1A-MAD01 | U, C, CE, N |
| | 3 Units max. (See note.) | Analog (resolution: 1/6000) | 2 | 1 |  | CPM1A-MAD11 | U, C, CE, N |
| DeviceNet I/O Link Unit | 3 Units max. (See note.) | --- | 32 (I/O link input bits) | 32 (I/O link output bits) |  | CPM1A-DRT21 | U, C, CE, N |
| CompoBus/S I/O Link Unit | 3 Units max. (See note.) | --- | I/O link of 8 input bits and 8 output bits | |  | CPM1A-SRT21 | U, C, CE, N |

Note: Only one Expansion Unit can be connected if an NT-AL001 Adapter is connected to the CPU Unit's RS-232C port.

■ Temperature Sensor Units

| Unit | Output type | Model | Standards |
|--------------------------|--|---|-------------|
| Temperature Sensor Units | 2 thermocouple inputs | CPM1A-TS001  | U, C, CE, N |
| | 4 thermocouple inputs | CPM1A-TS002  | U, C, CE, N |
| | 2 platinum resistance thermometer inputs | CPM1A-TS101  | U, C, CE, N |
| | 4 platinum resistance thermometer inputs | CPM1A-TS102  | U, C, CE, N |

Standard Models

■ RS-232C Adapter, RS-422 Adapter, Connecting Cable, Link Adapter

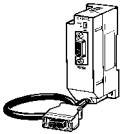
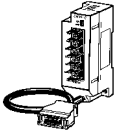
| Name | Function | Model | Standards |
|--|--|---------------|----------------|
| RS-232C Adapter  | Converts peripheral port levels. | CPM1-CIF01 | U, C, N, L, CE |
| RS-422 Adapter  | | CPM1-CIF11 | |
| Connecting Cable | 3.3-m cable used to connect IBM PC/AT or compatible personal computers. | CQM1-CIF02 | U, C, N, L, CE |
| USB-Serial Conversion Cable | Converts between USB and RS-232C, cable length: 0.5 m. PC Driver included (CD-ROM). Applicable OS: Windows 98, Me, 2000, or XP | CS1W-CIF31 | N, CE |
| Link Adapter | Converts RS-232C and RS-422 levels. | 3G2A9-AL004-E | --- |

■ Programming Console

| Name | Function | Model | Standards |
|---|--|---------------|-------------|
| Programming Console  | With a 2-m cable | CQM1-PRO01-E | U, C, N, CE |
| | --- | C200H-PRO27-E | U, C, N, CE |
| | 2-m Connecting Cable for C200H-PRO27-E | C200H-CN222 | N |
| | 4-m Connecting Cable for C200H-PRO27-E | C200H-CN422 | --- |

■ Programming Software

| Name | Operating system | Operating environment | Model |
|--|---|--|-------------------|
| CX-Programmer (1 licence) | Windows 95, 98, Me, NT 4.0, 2000, or XP | Used in IBM PC/AT or compatible personal computers (Pentium) | WS02-CXPC1-E-V4□ |
| CX-Programmer Junior Version (1 license, supports CPM□□ and SRM1 only) | Windows 95, 98, Me, NT 4.0, 2000, or XP | Used in IBM PC/AT or compatible personal computers (Pentium) | WS02-CXPC1-EJ-V4□ |

■ Backup Accessories

| Name | Model | Standards |
|--|---------------|-----------|
| Expansion Memory Unit | CPM1-EMU01-V1 | --- |
| 256-K EEPROM for Expansion Memory Unit | EEROM-JD | --- |

■ Power Supply Unit

| Unit | Input | Output | Model | Standards |
|----------------------|----------------|------------------|--|-----------|
| AC Power Supply Unit | 100 to 240 VAC | 600 mA at 24 VDC | CPM2C-PA201  | U, C, CE |

Expansion Memory Unit

■ Expansion Memory Unit

The Expansion Memory Unit allows programs to be uploaded and downloaded between PC and EEPROM with the press of a button. It is a useful device for program maintenance and correction.

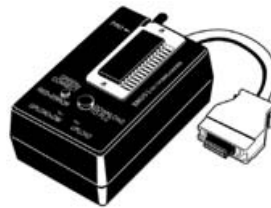

■ Connection Configuration

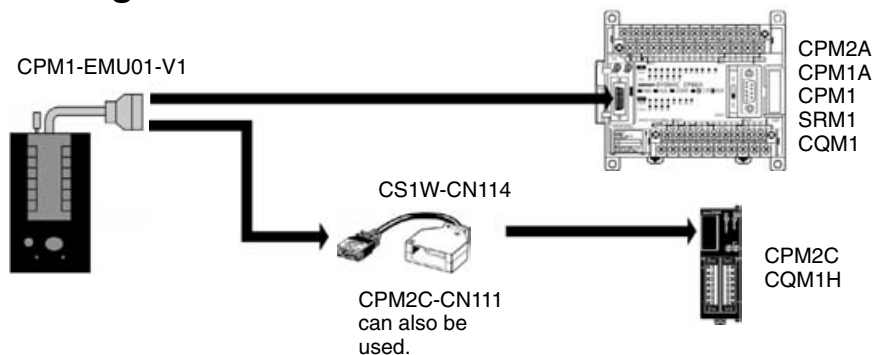

■ Specifications

| Item | Specifications |
|-----------------------------|---|
| Supported PCs | CPM1, CPM1A, CPM2A, CPM2C, SRM1 (-V2), CQM1, CQM1H |
| Read/Write memory areas | User program: 15.2 Kwords max. Data memory: DM 6144 to DM 6655 (Read-only DM and PC Setup) Expansion instructions: 18 instructions |
| Connector | Connector compatible with CPM1, CPM1A, CPM2A, SRM1 (-V2), and CQM1 PCs. For CPM2C and CQM1H PCs, connect via CS1W-CN114 or CPM2C-CN111 Connecting Cable. |
| EEPROM (sold separately) | 256-Kbit EEPROM ATMEL: AT28C256 OMRON: EEROM-JD |
| Current consumption | 129 mA max. |
| Dimensions | Main body (not including cables or connectors): 57 × 92 × 38 mm (W × H × D) |
| Weight | 200 g max. (not including EEPROM) |

■ Dimensions

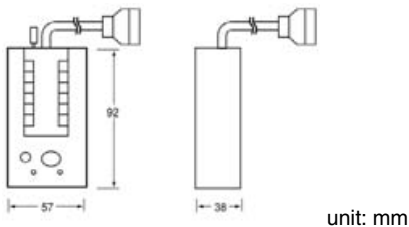

■ Memory Areas

The memory areas that are uploaded or downloaded vary with the button used as shown in the following table.

| Memory area | Button | | |
|---|-------------------------|-------------------------|---------------------------------------|
| | UPLOAD + DM | UPLOAD | DOWNLOAD |
| Ladder program and expansion instructions | Read from PC to EEPROM. | Read from PC to EEPROM. | All contents of EEPROM written to PC. |
| DM 6144 to 6655 | | Not affected. | |

Note: For details on program size, DM area, and the availability of expansion instructions, refer to the relevant PC manual.

Read and Understand this Catalog

Please read and understand this catalog before purchasing the product. Please consult your OMRON representative if you have any questions or comments.

Warranty and Limitations of Liability

WARRANTY

OMRON's exclusive warranty is that the products are free from defects in materials and workmanship for a period of one year (or other period if specified) from date of sale by OMRON.

OMRON MAKES NO WARRANTY OR REPRESENTATION, EXPRESS OR IMPLIED, REGARDING NON-INFRINGEMENT, MERCHANTABILITY, OR FITNESS FOR PARTICULAR PURPOSE OF THE PRODUCTS. ANY BUYER OR USER ACKNOWLEDGES THAT THE BUYER OR USER ALONE HAS DETERMINED THAT THE PRODUCTS WILL SUITABLY MEET THE REQUIREMENTS OF THEIR INTENDED USE. OMRON DISCLAIMS ALL OTHER WARRANTIES, EXPRESS OR IMPLIED.

LIMITATIONS OF LIABILITY

OMRON SHALL NOT BE RESPONSIBLE FOR SPECIAL, INDIRECT, OR CONSEQUENTIAL DAMAGES, LOSS OF PROFITS OR COMMERCIAL LOSS IN ANY WAY CONNECTED WITH THE PRODUCTS, WHETHER SUCH CLAIM IS BASED ON CONTRACT, WARRANTY, NEGLIGENCE, OR STRICT LIABILITY.

In no event shall the responsibility of OMRON for any act exceed the individual price of the product on which liability is asserted.

IN NO EVENT SHALL OMRON BE RESPONSIBLE FOR WARRANTY, REPAIR, OR OTHER CLAIMS REGARDING THE PRODUCTS UNLESS OMRON'S ANALYSIS CONFIRMS THAT THE PRODUCTS WERE PROPERLY HANDLED, STORED, INSTALLED, AND MAINTAINED AND NOT SUBJECT TO CONTAMINATION, ABUSE, MISUSE, OR INAPPROPRIATE MODIFICATION OR REPAIR.

Application Considerations

SUITABILITY FOR USE

OMRON shall not be responsible for conformity with any standards, codes, or regulations that apply to the combination of products in the customer's application or use of the products.

Take all necessary steps to determine the suitability of the product for the systems, machines, and equipment with which it will be used.

Know and observe all prohibitions of use applicable to the products.

NEVER USE THE PRODUCTS FOR AN APPLICATION INVOLVING SERIOUS RISK TO LIFE OR PROPERTY WITHOUT ENSURING THAT THE SYSTEM AS A WHOLE HAS BEEN DESIGNED TO ADDRESS THE RISKS, AND THAT THE OMRON PRODUCTS ARE PROPERLY RATED AND INSTALLED FOR THE INTENDED USE WITHIN THE OVERALL EQUIPMENT OR SYSTEM.

PROGRAMMABLE PRODUCTS

OMRON shall not be responsible for the user's programming of a programmable product, or any consequence thereof.

Disclaimers

CHANGE IN SPECIFICATIONS

Product specifications and accessories may be changed at any time based on improvements and other reasons. Consult with your OMRON representative at any time to confirm actual specifications of purchased products.

DIMENSIONS AND WEIGHTS

Dimensions and weights are nominal and are not to be used for manufacturing purposes, even when tolerances are shown.

PERFORMANCE DATA

Performance data given in this catalog is provided as a guide for the user in determining suitability and does not constitute a warranty. It may represent the result of OMRON's test conditions, and the users must correlate it to actual application requirements. Actual performance is subject to the OMRON Warranty and Limitations of Liability.