

OMRON

OMRON Corporation
Industrial Automation Company

Control Devices Division H.Q.
Analog Controller Division
Shiokoji Horikawa, Shimogyo-ku,
Kyoto, 600-8530 Japan
Tel: (81)75-344-7080/Fax: (81)75-344-7189

Regional Headquarters

OMRON EUROPE B.V.
Wegalaan 67-69, NL-2132 JD Hoofddorp
The Netherlands
Tel: (31)2356-81-300/Fax: (31)2356-81-388

OMRON ELECTRONICS LLC
1 East Commerce Drive, Schaumburg, IL 60173
U.S.A.
Tel: (1)847-843-7900/Fax: (1)847-843-8568

OMRON ASIA PACIFIC PTE. LTD.
83 Clemenceau Avenue,
#11-01, UE Square,
239920 Singapore
Tel: (65)6835-3011/Fax: (65)6835-2711

OMRON (CHINA) CO., LTD.
Room 2211, Bank of China Tower,
200 Yin Cheng Road (M),
Shanghai, 200120 China
Tel: (86)21-5037-2222/Fax: (86)21-5037-2200

Authorized Distributor:



Digital Temperature Controller with 11-segment Display

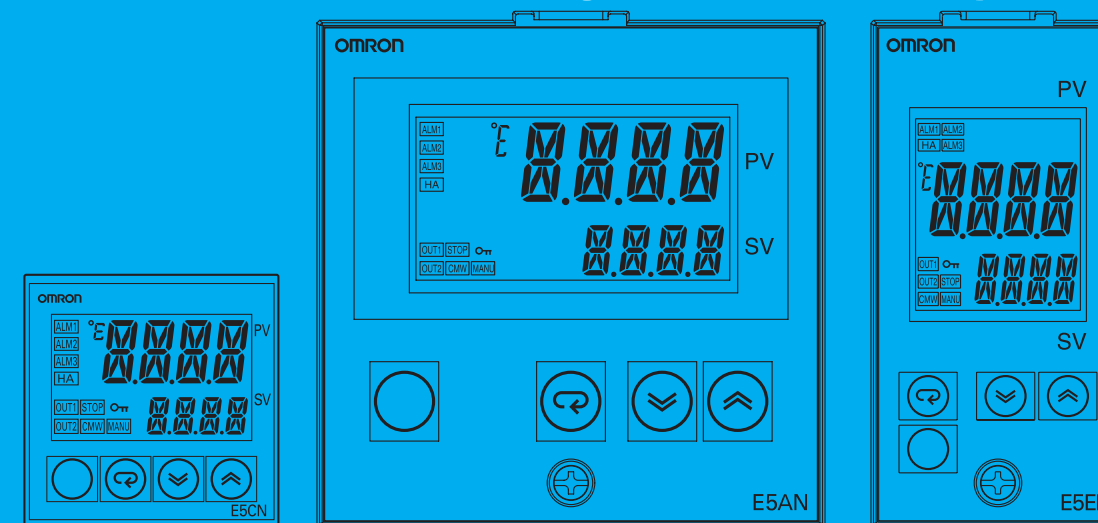

User's Manual

E5CN/E5CN-U/E5AN/E5EN

Digital Temperature Controller

User's Manual

Revised November 2005

Preface

OMRON products are manufactured for use according to proper procedures by a qualified operator and only for the purposes described in this manual.

The E5CN, E5CN-U, E5AN, and E5EN are Digital Temperature Controllers. The E5CN and E5CN-U are both compact temperature controllers, with the E5CN featuring screw terminal connections, and the E5CN-U featuring socket pin connections. The main functions and characteristics of these Digital Temperature Controllers are as follows:

- Any of the following types of input can be used: thermocouple, platinum resistance thermometer, infrared sensor, analog voltage, or analog current.
- Either standard or heating/cooling control can be performed.
- Both auto-tuning and self-tuning are supported.
- Event inputs can be used to switch set points (multi-SP function), switch between RUN and STOP status, switch between automatic and manual operation, and start/reset the simple program function. (Event input are not applicable to the E5CN-U.)
- Heater burnout detection and HS alarms are supported. (Applicable to E5CN, E5AN, and E5EN models with heater burnout detection function.)
- Communications are supported. (Applicable to E5CN, E5AN, and E5EN models with communications.)
- User calibration of the sensor input is supported.
- The structure is waterproof (NEMA 4X indoor use, equivalent to IP66). (Not applicable to the E5CN-U.)
- Conforms to UL, CSA, and IEC safety standards and EMC Directive.
- The PV display color can be switched to make process status easy to understand at a glance.

This manual describes the E5CN, E5CN-U, E5AN, and E5EN. Read this manual thoroughly and be sure you understand it before attempting to use the Digital Temperature Controller and use the Digital Temperature Controller correctly according to the information provided. Keep this manual in a safe place for easy reference. Refer to the following manual for further information on communications: *E5CN Digital Temperature Controller Communications Functions User's Manual* (Cat. No. H130).

Visual Aids

The following headings appear in the left column of the manual to help you locate different types of information.

Note Indicates information of particular interest for efficient and convenient operation of the product.

1,2,3... 1. Indicates lists of one sort or another, such as procedures, checklists, etc.

© OMRON, 2005

All rights reserved. No part of this publication may be reproduced, stored in a retrieval system, or transmitted, in any form, or by any means, mechanical, electronic, photocopying, recording, or otherwise, without the prior written permission of OMRON.

No patent liability is assumed with respect to the use of the information contained herein. Moreover, because OMRON is constantly striving to improve its high-quality products, the information contained in this manual is subject to change without notice. Every precaution has been taken in the preparation of this manual. Nevertheless, OMRON assumes no responsibility for errors or omissions. Neither is any liability assumed for damages resulting from the use of the information contained in this publication.

Read and Understand this Manual

Please read and understand this manual before using the product. Please consult your OMRON representative if you have any questions or comments.

Warranty and Limitations of Liability

WARRANTY

OMRON's exclusive warranty is that the products are free from defects in materials and workmanship for a period of one year (or other period if specified) from date of sale by OMRON.

OMRON MAKES NO WARRANTY OR REPRESENTATION, EXPRESS OR IMPLIED, REGARDING NON-INFRINGEMENT, MERCHANTABILITY, OR FITNESS FOR PARTICULAR PURPOSE OF THE PRODUCTS. ANY BUYER OR USER ACKNOWLEDGES THAT THE BUYER OR USER ALONE HAS DETERMINED THAT THE PRODUCTS WILL SUITABLY MEET THE REQUIREMENTS OF THEIR INTENDED USE. OMRON DISCLAIMS ALL OTHER WARRANTIES, EXPRESS OR IMPLIED.

LIMITATIONS OF LIABILITY

OMRON SHALL NOT BE RESPONSIBLE FOR SPECIAL, INDIRECT, OR CONSEQUENTIAL DAMAGES, LOSS OF PROFITS OR COMMERCIAL LOSS IN ANY WAY CONNECTED WITH THE PRODUCTS, WHETHER SUCH CLAIM IS BASED ON CONTRACT, WARRANTY, NEGLIGENCE, OR STRICT LIABILITY.

In no event shall the responsibility of OMRON for any act exceed the individual price of the product on which liability is asserted.

IN NO EVENT SHALL OMRON BE RESPONSIBLE FOR WARRANTY, REPAIR, OR OTHER CLAIMS REGARDING THE PRODUCTS UNLESS OMRON'S ANALYSIS CONFIRMS THAT THE PRODUCTS WERE PROPERLY HANDLED, STORED, INSTALLED, AND MAINTAINED AND NOT SUBJECT TO CONTAMINATION, ABUSE, MISUSE, OR INAPPROPRIATE MODIFICATION OR REPAIR.

Application Considerations

SUITABILITY FOR USE

OMRON shall not be responsible for conformity with any standards, codes, or regulations that apply to the combination of products in the customer's application or use of the products.

At the customer's request, OMRON will provide applicable third party certification documents identifying ratings and limitations of use that apply to the products. This information by itself is not sufficient for a complete determination of the suitability of the products in combination with the end product, machine, system, or other application or use.

The following are some examples of applications for which particular attention must be given. This is not intended to be an exhaustive list of all possible uses of the products, nor is it intended to imply that the uses listed may be suitable for the products:

- Outdoor use, uses involving potential chemical contamination or electrical interference, or conditions or uses not described in this manual.
- Nuclear energy control systems, combustion systems, railroad systems, aviation systems, medical equipment, amusement machines, vehicles, safety equipment, and installations subject to separate industry or government regulations.
- Systems, machines, and equipment that could present a risk to life or property.

Please know and observe all prohibitions of use applicable to the products.

NEVER USE THE PRODUCTS FOR AN APPLICATION INVOLVING SERIOUS RISK TO LIFE OR PROPERTY WITHOUT ENSURING THAT THE SYSTEM AS A WHOLE HAS BEEN DESIGNED TO ADDRESS THE RISKS, AND THAT THE OMRON PRODUCTS ARE PROPERLY RATED AND INSTALLED FOR THE INTENDED USE WITHIN THE OVERALL EQUIPMENT OR SYSTEM.

PROGRAMMABLE PRODUCTS

OMRON shall not be responsible for the user's programming of a programmable product, or any consequence thereof.

Disclaimers

CHANGE IN SPECIFICATIONS

Product specifications and accessories may be changed at any time based on improvements and other reasons.

It is our practice to change model numbers when published ratings or features are changed, or when significant construction changes are made. However, some specifications of the products may be changed without any notice. When in doubt, special model numbers may be assigned to fix or establish key specifications for your application on your request. Please consult with your OMRON representative at any time to confirm actual specifications of purchased products.

DIMENSIONS AND WEIGHTS

Dimensions and weights are nominal and are not to be used for manufacturing purposes, even when tolerances are shown.

PERFORMANCE DATA

Performance data given in this manual is provided as a guide for the user in determining suitability and does not constitute a warranty. It may represent the result of OMRON's test conditions, and the users must correlate it to actual application requirements. Actual performance is subject to the OMRON Warranty and Limitations of Liability.

ERRORS AND OMISSIONS

The information in this document has been carefully checked and is believed to be accurate; however, no responsibility is assumed for clerical, typographical, or proofreading errors, or omissions.

Safety Precautions

■ Definition of Precautionary Information

The following notation is used in this manual to provide precautions required to ensure safe usage of the product.

The safety precautions that are provided are extremely important to safety. Always read and heed the information provided in all safety precautions.

The following notation is used.









Indicates a potentially hazardous situation which, if not avoided, is likely to result in minor or moderate injury or in property damage.

■ Symbols

Symbol		Meaning
Caution		General Caution Indicates non-specific general cautions, warnings, and dangers.
		Electrical Shock Caution Indicates possibility of electric shock under specific conditions.
Prohibition		General Prohibition Indicates non-specific general prohibitions.
		Disassembly Prohibition Indicates prohibitions when there is a possibility of injury, such as from electric shock, as the result of disassembly.
Mandatory Caution		General Caution Indicates non-specific general cautions, warnings, and dangers.

■ Safety Precautions

 CAUTION	
Do not touch the terminals while power is being supplied. Doing so may occasionally result in minor injury due to electric shock.	
Do not allow pieces of metal, wire clippings, or fine metallic shavings or filings from installation to enter the product. Doing so may occasionally result in electric shock, fire, or malfunction.	
Do not use the product where subject to flammable or explosive gas. Otherwise, minor injury from explosion may occasionally occur.	
Never disassemble, modify, or repair the product or touch any of the internal parts. Minor electric shock, fire, or malfunction may occasionally occur.	
<p>CAUTION - Risk of Fire and Electric Shock</p> <p>a) This product is UL listed as Open Type Process Control Equipment. It must be mounted in an enclosure that does not allow fire to escape externally.</p> <p>b) More than one disconnect switch may be required to de-energize the equipment before servicing the product.</p> <p>c) Signal inputs are SELV, limited energy.*1</p> <p>d) Caution: To reduce the risk of fire or electric shock, do not interconnect the outputs of different Class 2 circuits.*2</p>	
If the output relays are used past their life expectancy, contact fusing or burning may occasionally occur. Always consider the application conditions and use the output relays within their rated load and electrical life expectancy. The life expectancy of output relays varies considerably with the output load and switching conditions.	

*1 A SELV circuit is one separated from the power supply with double insulation or reinforced insulation, that does not exceed 30 V r.m.s. and 42.4 V peak or 60 VDC.

*2 A class 2 power supply is one tested and certified by UL as having the current and voltage of the secondary output restricted to specific levels.

 **CAUTION**

Tighten the terminal screws to between 1.13 and 1.36 N·m. Loose screws may occasionally result in fire. (See note.)

Set the parameters of the product so that they are suitable for the system being controlled. If they are not suitable, unexpected operation may occasionally result in property damage or accidents.

A malfunction in the Temperature Controller may occasionally make control operations impossible or prevent alarm outputs, resulting in property damage. To maintain safety in the event of malfunction of the Temperature Controller, take appropriate safety measures, such as installing a monitoring device on a separate line.

A semiconductor is used in the output section of long-life relays. If excessive noise or surge is impressed on the output terminals, a short-circuit failure is likely to occur. If the output remains shorted, fire will occur due to overheating of the heater or other cause. Take measures in the overall system to prevent excessive temperature increase and to prevent fire from spreading.



Note The tightening torque for E5CN-U is 0.5 N·m.

Precautions for Safe Use

Be sure to observe the following precautions to prevent operation failure, malfunction, or adverse affects on the performance and functions of the product. Not doing so may occasionally result in unexpected events.

- 1) The product is designed for indoor use only. Do not use the product outdoors or in any of the following locations.
 - Places directly subject to heat radiated from heating equipment.
 - Places subject to splashing liquid or oil atmosphere.
 - Places subject to direct sunlight.
 - Places subject to dust or corrosive gas (in particular, sulfide gas and ammonia gas).
 - Places subject to intense temperature change.
 - Places subject to icing and condensation.
 - Places subject to vibration and large shocks.
- 2) Use and store the Digital Temperature Controller within the rated ambient temperature and humidity. Gang-mounting two or more temperature controllers, or mounting temperature controllers above each other may cause heat to build up inside the temperature controllers, which will shorten their service life. In such a case, use forced cooling by fans or other means of air ventilation to cool down the Digital Temperature Controllers.
- 3) To allow heat to escape, do not block the area around the product. Do not block the ventilation holes on the product.
- 4) Be sure to wire properly with correct polarity of terminals.
- 5) Use the specified size (M3.5, width 7.2 mm or less) crimped terminals for wiring. For open-wired connection, use stranded or solid copper wires with a gage of AWG24 to AWG14 (equal to a cross-sectional area of 0.205 to 2.081 mm²). (The stripping length is 5 to 6 mm.) Up to two wires or two crimp terminals can be inserted into a single terminal.
- 6) Do not wire the terminals which are not used.
- 7) To avoid inductive noise, keep the wiring for the Digital Temperature Controller's terminal block away from power cables carry high voltages or large currents. Also, do not wire power lines together with or parallel to Digital Temperature Controller wiring. Using shielded cables and using separate conduits or ducts is recommended.

Attach a surge suppressor or noise filter to peripheral devices that generate noise (in particular, motors, transformers, solenoids, magnetic coils or other equipment that have an inductance component).
When a noise filter is used at the power supply, first check the voltage or current, and attach the noise filter as close as possible to the temperature controller.
Allow as much space as possible between the Digital Temperature Controller and devices that generate powerful high frequencies (high-frequency welders, high-frequency sewing machines, etc.) or surge.
- 8) Use this product within the rated load and power supply.
- 9) Make sure that the rated voltage is attained within two seconds of turning ON the power using a switch or relay contact. If the voltage is applied gradually, the power may not be reset or output malfunctions may occur.
- 10) Make sure that the Temperature Controller has 30 minutes or more to warm up after turning ON the power before starting actual control operations to ensure the correct temperature display.
- 11) When executing self-tuning, turn ON power for the load (e.g., heater) at the same time as or before supplying power to the Digital Temperature Controller. If power is turned ON for the Digital Temperature Controller before turning ON power for the load, self-tuning will not be performed properly and optimum control will not be achieved.
- 12) A switch or circuit breaker should be provided close to this unit. The switch or circuit breaker should be within easy reach of the operator, and must be marked as a disconnecting means for this unit.
- 13) Always turn OFF the power supply before pulling out the interior of the product, and never touch nor apply shock to the terminals or electronic components. When inserting the interior of the product, do not allow the electronic components to touch the case.

- 14) Do not use paint thinner or similar chemical to clean with. Use standard grade alcohol.
- 15) Design system (control panel, etc) considering the 2 second of delay that the controller's output to be set after power ON.
- 16) The output may turn OFF when shifting to certain levels. Take this into consideration when performing control.
- 17) The number of EEPROM write operations is limited. Therefore, use RAM write mode when frequently overwriting data during communications or other operations.

● Service Life

Use the Temperature Controller within the following temperature and humidity ranges:

Temperature: -10 to 55°C (with no icing or condensation), Humidity: 25% to 85%

If the Controller is installed inside a control board, the ambient temperature must be kept to under 55°C, including the temperature around the Controller.

The service life of electronic devices like Temperature Controllers is determined not only by the number of times the relay is switched but also by the service life of internal electronic components. Component service life is affected by the ambient temperature: the higher the temperature, the shorter the service life and, the lower the temperature, the longer the service life. Therefore, the service life can be extended by lowering the temperature of the Temperature Controller.

When two or more Temperature Controllers are mounted horizontally close to each other or vertically next to one another, the internal temperature will increase due to heat radiated by the Temperature Controllers and the service life will decrease. In such a case, use forced cooling by fans or other means of air ventilation to cool down the Temperature Controllers. When providing forced cooling, however, be careful not to cool down the terminals sections alone to avoid measurement errors.

● Ambient Noise

To avoid inductive noise, keep the wiring for the Digital Temperature Controller's terminal block wiring away from power cables carrying high voltages or large currents. Also, do not wire power lines together with or parallel to Digital Temperature Controller wiring. Using shielded cables and using separate conduits or ducts is recommended.

Attach a surge suppressor or noise filter to peripheral devices that generate noise (in particular, motors, transformers, solenoids, magnetic coils or other equipment that have an inductance component). When a noise filter is used at the power supply, first check the voltage or current, and attach the noise filter as close as possible to the Temperature Controller.

Allow as much space as possible between the Digital Temperature Controller and devices that generate powerful high frequencies (high-frequency welders, high-frequency sewing machines, etc.) or surge.

● Ensuring Measurement Accuracy

When extending or connecting the thermocouple lead wire, be sure to use compensating wires that match the thermocouple types.

When extending or connecting the lead wire of the platinum resistance thermometer, be sure to use wires that have low resistance and keep the resistance of the three lead wires the same.

Mount the Temperature Controller so that it is horizontally level.

If the measurement accuracy is low, check to see if input shift has been set correctly.

● Waterproofing

The degree of protection is as shown below. Sections without any specification on their degree of protection or those with IP□0 are not waterproof.

Front panel: NEMA4X for indoor use (equivalent to IP66)

Rear case: IP20, Terminal section: IP00

(E5CN-U: Front panel: Equivalent to IP50, rear case: IP20, terminals: IP00)

Precautions for Operation

- 1) It takes approximately two seconds for the outputs to turn ON from after the power supply is turned ON. Due consideration must be given to this time when incorporating Temperature Controllers into a control panel or similar device.
- 2) Make sure that the Temperature Controller has 30 minutes or more to warm up after turning ON the power before starting actual control operations to ensure the correct temperature display.
- 3) When executing self-tuning, turn ON power for the load (e.g., heater) at the same time as or before supplying power to the Temperature Controller. If power is turned ON for the Temperature Controller before turning ON power for the load, self-tuning will not be performed properly and optimum control will not be achieved. When starting operation after the Temperature Controller has warmed up, turn OFF the power and then turn it ON again at the same time as turning ON power for the load. (Instead of turning the Temperature Controller OFF and ON again, switching from STOP mode to RUN mode can also be used.)
- 4) Avoid using the Controller in places near a radio, television set, or wireless installing. The Controller may cause radio disturbance for these devices.

Preparations for Use

Be sure to thoroughly read and understand the manual provided with the product, and check the following points.

Timing	Check point	Details
Purchasing the product	Product appearance	After purchase, check that the product and packaging are not dented or otherwise damaged. Damaged internal parts may prevent optimum control.
	Product model and specifications	Make sure that the purchased product meets the required specifications.
Setting the Unit	Product installation location	Provide sufficient space around the product for heat dissipation. Do not block the vents on the product.
Wiring	Terminal wiring	Do not subject the terminal screws to excessive stress (force) when tightening them. Make sure that there are no loose screws after tightening terminal screws to the specified torque of 1.13 to 1.36 N·m (see note). Be sure to confirm the polarity for each terminal before wiring the terminal block and connectors.
	Power supply inputs	Wire the power supply inputs correctly. Incorrect wiring will result in damage to the internal circuits.
Operating environment	Ambient temperature	The ambient operating temperature for the product is -10 to 55°C (with no condensation or icing). To extend the service life of the product, install it in a location with an ambient temperature as low as possible. In locations exposed to high temperatures, if necessary, cool the products using a fan or other cooling method.
	Vibration and shock	Check whether the standards related to shock and vibration are satisfied at the installation environment. (Install the product in locations where the conductors will not be subject to vibration or shock.)
	Foreign particles	Install the product in a location that is not subject to liquid or foreign particles entering the product.

Note The tightening torque for E5CN-U is 0.5 N·m.

Improved Functions

Functional upgrades have been implemented for E5CN/CN-U Digital Temperature Controllers of lot number 01440 (manufactured 1 April 2004) or later, and for E5AN/EN Digital Temperature Controllers of lot number 01150 (manufactured 1 January 2005) or later. The previous and improved models can be distinguished by the front panel, as shown below.

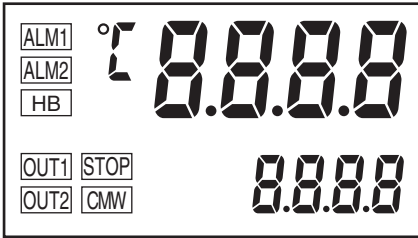
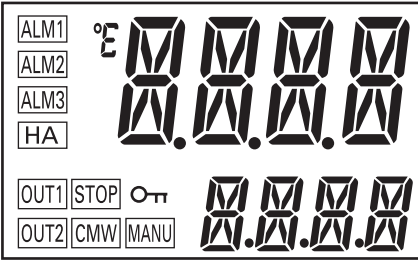
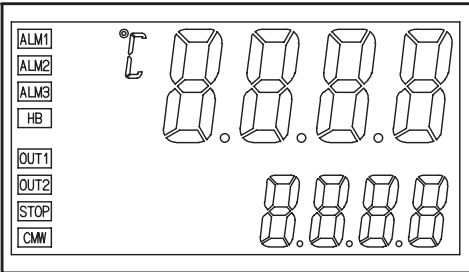
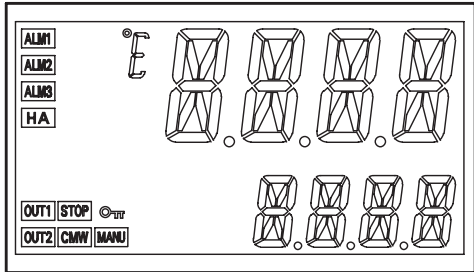
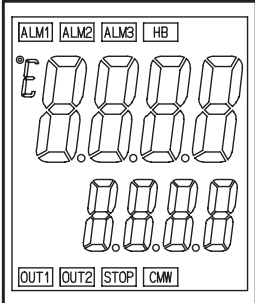
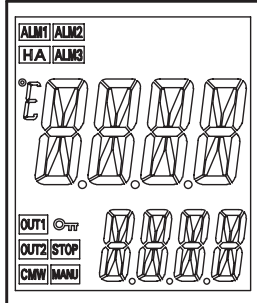
	Previous models	Improved function models
E5CN/CN-U		
E5AN		
E5EN		

Basically, the Controllers are upwardly compatible. The terminal arrangement, terminal sizes, and depth for panel mounting have not been changed. Changes are listed in the following tables. For details, refer to the pages given for specific items in the index.

■ Ratings

Item	Previous models	Improved models
Power consumption	E5CN 7 VA (100 to 240 VAC, 50/60 Hz) 4 VA/3 W (24 VAC, 50/60 Hz or 24 VDC)	7.5 VA (100 to 240 VAC, 50/60 Hz) 5 VA/3 W (24 VAC, 50/60 Hz or 24 VDC)
	E5CN-U 6 VA (100 to 240 VAC, 50/60 Hz) 3 VA/2 W (24 VAC, 50/60 Hz or 24 VDC)	6 VA (100 to 240 VAC, 50/60 Hz) 3 VA/2 W (24 VAC, 50/60 Hz or 24 VDC)
	E5AN 9 VA (100 to 240 VAC, 50/60 Hz) 5 VA/4 W (24 VAC, 50/60 Hz or 24 VDC)	11 VA 5.5 VA/4 W
	E5EN 9 VA (100 to 240 VAC, 50/60 Hz) 5 VA/4 W (24 VAC, 50/60 Hz or 24 VDC)	10 VA 5.5 VA/4 W
Sensor input	E5□N-□□TC Thermocouple: K, J, T, E, L, U, N, R, S, or B Infrared temperature sensor: 10 to 70°C, 60 to 120°C or 115 to 165°C (160 to 260°C) Voltage input: 0 to 50 mV	E5□N-□□T (Multi-input models) Thermocouple: K, J, T, E, L, U, N, R, S, or B Infrared temperature sensor: 10 to 70°C, 60 to 120°C or 115 to 165°C (140 to 260°C) Voltage input: 0 to 50 mV Platinum resistance thermometer: Pt100 or JPt100
	E5□N-□□P Platinum resistance thermometer: Pt100 or JPt100	
	(No models with analog inputs)	E5□N-□□L (Models with analog inputs added.) Current input: 4 to 20 mA or 0 to 20 mA Voltage input: 1 to 5 V, 0 to 5 V, or 0 to 10 V

Item		Previous models	Improved models
Control output 1	Relay	E5CN-R□□ SPST-NO, 250 VAC, 3 A (resistive load) Electrical life: 100,000 operations min.	E5CN-R□□ SPST-NO, 250 VAC, 3 A (resistive load) Electrical life: 100,000 operations min.
		E5CN-R□□U SPDT, 250 VAC, 3 A (resistive load) Electrical life: 100,000 operations min.	E5CN-R□□U SPDT, 250 VAC, 3 A (resistive load) Electrical life: 100,000 operations min.
		E5AN-R□□ SPST-NO, 250 VAC, 5 A (resistive load) Electrical life: 100,000 operations min.	E5AN-R□□ SPST-NO, 250 VAC, 5 A (resistive load) Electrical life: 100,000 operations min.
		E5EN-R□□ SPST-NO, 250 VAC, 5 A (resistive load) Electrical life: 100,000 operations min.	E5EN-R□□ SPST-NO, 250 VAC, 5 A (resistive load) Electrical life: 100,000 operations min.
	Long-life relay	(No model with long-life relays)	E5CN-Y□□ (Added models with long-life relay outputs.) SPST-NO, 250 VAC, 3 A (resistive load) Electrical life: 1,000,000 operations min. DC loads cannot be connected.
	Voltage	E5CN-Q□□ 12 VDC ±15% (PNP) Max. load current: 21 mA With short-circuit protection	E5CN-Q□□ 12 VDC ±15% (PNP) Max. load current: 21 mA With short-circuit protection
		E5AN-Q□□ 12 VDC +15%/–20% (PNP) Max. load current: 40 mA With short-circuit protection	E5AN-Q□□ 12 VDC +15%/–20% (PNP) Max. load current: 40 mA With short-circuit protection
		E5EN-Q□□ 12 VDC +15%/–20% (PNP) Max. load current: 40 mA With short-circuit protection	E5EN-Q□□ 12 VDC +15%/–20% (PNP) Max. load current: 40 mA With short-circuit protection
	Current	E5CN-C□□ 4 to 20 mA DC Load: 600 Ω max. Resolution: Approx. 2,600	E5CN-C□□ 4 to 20 mA DC or 0 to 20 mA DC Load: 600 Ω max. Resolution: Approx. 2,700
		E5AN-C□□ 4 to 20 mA DC Load: 600 Ω max. Resolution: Approx. 2,600	E5AN-C□□ 4 to 20 mA DC or 0 to 20 mA DC Load: 600 Ω max. Resolution: Approx. 2,700
E5EN-C□□ 4 to 20 mA DC Load: 600 Ω max. Resolution: Approx. 2,600		E5EN-C□□ 4 to 20 mA DC or 0 to 20 mA DC Load: 600 Ω max. Resolution: Approx. 2,700	
Control output 2	Long-life relay	---	E5AN/EN-□Y□ (Added models with long-life relay outputs.) SPST-NO, 250 VAC, 3 A (resistive load) Electrical life: 1,000,000 operations min. DC loads cannot be connected.
	Voltage	(No models with two control outputs)	E5CN-□Q□ 12 VDC ±15% (PNP) Max. load current: 21 mA With short-circuit protection
		(No models with two control outputs)	E5AN/EN-□Q□ 12 VDC +15%/–20% (PNP) Max. load current: 21 mA With short-circuit protection

Item		Previous models	Improved models
Display method	E5CN	7-segment digital display and single-LED indicators Character height: PV: 9.9 mm, SV: 6.4 mm	11-segment digital display and single-LED indicator (Improved visibility) (A 7-segment digital display also possible.) Character height: PV: 11.0 mm, SV: 6.5 mm
	E5AN/EN	7-segment digital display and single-LED indicators	11-segment digital display and single-LED indicator (Improved visibility) (A 7-segment digital display also possible.) Character height: Same
Transfer output		(No models with transfer outputs)	E5CN-C□□ (current output) Allocated to current output 4 to 20 mA DC or 0 to 20 mA DC Load: 600 Ω max. Resolution: Approx. 2,700 (4 to 20 mA DC) Approx. 3,400 (0 to 20 mA DC)

■ Other Functions

Item	Previous models	Improved models
Display	---	Parameter mask function (provided with setting software)
	PV display switch between 2 colors (red/green)	PV display switch between 3 colors (red/orange/green)
	---	Display character switch (7-segment/11-segment)
Input	Temperature input shift (1-point shift for temperature input)	Temperature input shift (2-point shift also possible for temperature input)
Output	---	Manual outputs
	---	MV at stop
	---	MV at PV error
	---	Loop break alarm
Control	Control period: 1 to 99 s	Control period: 0.5 or 1 to 99 s
	---	Robust tuning
Alarm	---	Alarm delays
	---	Alarm SP selection (selection of alarm operation of SP indicator)
Other	---	Simple programming function
	---	Password to move to protect level

■ Characteristics

Item	Previous models	Improved models
Sampling period	500 ms	250 ms

■ Communications Specifications

Item	Previous models	Improved models
Communications protocols	CompoWay/F (SYSWAY)	CompoWay/F (SYSWAY), Modbus
Communications baud rate	1200, 2400, 4800, 9600, 19200 bps	1200, 2400, 4800, 9600, 19200, 38400 bps

■ Heater Burnout/HS Alarm Characteristics

Item	Previous models	Improved models
Maximum heater current	E5□N-□□H□ Single-phase 50 A AC	E5□N-□□H□ Single-phase 50 A AC
	---	E5□N-□□HH□ (two CT inputs) Three-phase 50 A AC
HS alarm	---	HS alarm

Conventions Used in This Manual

Model Notations

“E5CN, E5CN-U, E5AN, and E5EN” is used when the information being provided applies to all E5CN-□□□, E5CN-□□□U, E5AN-□□□, or E5EN-□□□ Digital Temperature Controllers. The notation used in the manual (e.g., for model designations in *SECTION 5 Parameters*) for information that is restricted by the model is given in the following table.

Notation	Optional functions
E5□N-□□□B	Two event inputs
E5□N-□□□03	RS-485 communications
E5□N-□□□H	Heater burnout and HS alarms for 1 point
E5□N-□□□HH	Heater burnout and HS alarms for 2 points
E5□N-□□Q	Control output 2 (voltage output)
E5□N-□□□P	External power supply for ES1B
E5□N-□□□01	RS-232C communications (See note.)

Note Supported for E5AN and E5EN only.

Meanings of Abbreviations

The following abbreviations are used in parameter names, figures and in text explanations. These abbreviations mean the following:

Symbol	Term
PV	Process value
SP	Set point
SV	Set value
AT	Auto-tuning
ST	Self-tuning
HS	Heater short (See note 1.)
EU	Engineering unit (See note 2.)

Note: (1) A heater short indicates that the heater remains ON even when the control output from the Temperature Controller is OFF because the SSR has failed or for any other reason.

(2) “EU” stands for Engineering Unit. EU is used as the minimum unit for engineering units such as °C, m, and g. The size of EU varies according to the input type.

For example, when the input temperature setting range is –200 to +1300°C, 1 EU is 1°C, and when the input temperature setting range is –20.0 to +500.0°C, 1 EU is 0.1°C.

For analog inputs, the size of EU varies according to the decimal point position of the scaling setting, and 1 EU becomes the minimum scaling unit.

How to Read Display Symbols

The following tables show the correspondence between the symbols displayed on the displays and alphabet characters. The default is for 11-segment displays.

A	b	C	d	E	F	G	H	I	J	K	L	M
A	B	C	D	E	F	G	H	I	J	K	L	M

N	ō	P	Q	R	S	T	U	V	W	X	Y	Z
N	O	P	Q	R	S	T	U	V	W	X	Y	Z

The "character select" parameter in the advanced function setting level can be turned OFF to display the following 7-segment characters.

A	b	C	d	E	F	G	H	I	J	K	L	M
A	B	C	D	E	F	G	H	I	J	K	L	M

n	ō	P	q	r	S	T	U	v	Y	ū	Y	Ξ
N	O	P	Q	R	S	T	U	V	W	X	Y	Z

TABLE OF CONTENTS

SECTION 1

Introduction	1
1-1 Names of Parts	2
1-2 I/O Configuration and Main Functions	5
1-3 Setting Level Configuration and Key Operations	10
1-4 Communications Function	13

SECTION 2

Preparations	15
2-1 Installation	16
2-2 Wiring Terminals	21
2-3 Using the Support Software Port	30

SECTION 3

Basic Operation	33
3-1 Initial Setting Examples	34
3-2 Setting the Input Type	36
3-3 Selecting the Temperature Unit	38
3-4 Selecting PID Control or ON/OFF Control	38
3-5 Setting Output Specifications	38
3-6 Setting the Set Point (SP)	42
3-7 Using ON/OFF Control	43
3-8 Determining PID Constants (AT, ST, Manual Setup)	45
3-9 Alarm Outputs	51
3-10 Using HBA and HS Alarms	54

SECTION 4

Applications Operations	65
4-1 Shifting Input Values	67
4-2 Alarm Hysteresis	71
4-3 Setting Scaling Upper and Lower Limits for Analog Inputs	73
4-4 Executing Heating/Cooling Control	74
4-5 Using Event Inputs	77
4-6 Setting the SP Upper and Lower Limit Values	81
4-7 Using the SP Ramp Function to Limit the SP Change Rate	82
4-8 Moving to the Advanced Function Setting Level	84
4-9 Using the Key Protect Level	85
4-10 PV Change Color	89
4-11 Alarm Delays	92
4-12 Loop Break Alarm	94
4-13 Performing Manual Control	97
4-14 Using the Transfer Output	101
4-15 Using the Simple Program Function	104
4-16 Output Adjustment Functions	110

TABLE OF CONTENTS

SECTION 5

Parameters	113
5-1 Conventions Used in this Section	114
5-2 Protect Level	115
5-3 Operation Level	118
5-4 Adjustment Level	129
5-5 Manual Control Level	144
5-6 Initial Setting Level	145
5-7 Advanced Function Setting Level	157
5-8 Communications Setting Level	182

SECTION 6

CALIBRATION	183
6-1 Parameter Structure	184
6-2 User Calibration	186
6-3 Thermocouple Calibration (Thermocouple/Resistance Thermometer Input)	186
6-4 Platinum Resistance Thermometer Calibration (Thermocouple/Resistance Thermometer Input)	190
6-5 Analog Input Calibration (Thermocouple/Resistance Thermometer Input)	192
6-6 Calibrating Analog Input (Analog Input)	193
6-7 Checking Indication Accuracy	195

Appendix A	199
-------------------	------------

Index	225
--------------	------------

Revision History	231
-------------------------	------------

About this Manual:

This manual describes the E5CN/CN-U/AN/EN Digital Temperature Controllers and includes the sections described below.

Please read this manual carefully and be sure you understand the information provided before attempting to set up or operate an E5CN/CN-U/AN/EN Digital Temperature Controller.

• Overview

Section 1 introduces the features, components, and main specifications of the E5CN/CN-U/AN/EN Digital Temperature Controllers.

• Setup

Section 2 describes the work required to prepare the E5CN/CN-U/AN/EN Digital Temperature Controllers for operation, including installation and wiring.

• Basic Operations

Section 3 describes the basic operation of the E5CN/CN-U/AN/EN Digital Temperature Controllers, including key operations to set parameters and descriptions of display elements based on specific control examples.

Section 5 describes the individual parameters used to set up, control, and monitor operation.

• Operations for Applications

Section 4 describes scaling, the SP ramp function, and other special functions that can be used to make the most of the functionality of the E5CN/CN-U/AN/EN Digital Temperature Controllers.

Section 5 describes the individual parameters used to setup, control, and monitor operation.

• User Calibration

Section 6 describes how the user can calibrate the E5CN/CN-U/AN/EN Digital Temperature Controllers.

• Appendices

The **Appendix** provides information for easy reference, including lists of parameters and settings.



WARNING Failure to read and understand the information provided in this manual may result in personal injury or death, damage to the product, or product failure. Please read each section in its entirety and be sure you understand the information provided in the section and related sections before attempting any of the procedures or operations given.

SECTION 1

Introduction

This section introduces the features, components, and main specifications of the E5CN and E5CN-U Digital Temperature Controllers.

- 1-1 Names of Parts 2
 - 1-1-1 Front Panel 2
 - 1-1-2 Meanings of Indicators 3
 - 1-1-3 Using the Keys 4
- 1-2 I/O Configuration and Main Functions 5
 - 1-2-1 I/O Configuration 5
 - 1-2-2 Main Functions 8
- 1-3 Setting Level Configuration and Key Operations 10
 - 1-3-1 Selecting Parameters 12
 - 1-3-2 Fixing Settings 12
- 1-4 Communications Function 13

1-1 Names of Parts

1-1-1 Front Panel

E5CN/CN-U

The front panel is the same for the E5CN and E5CN-U.

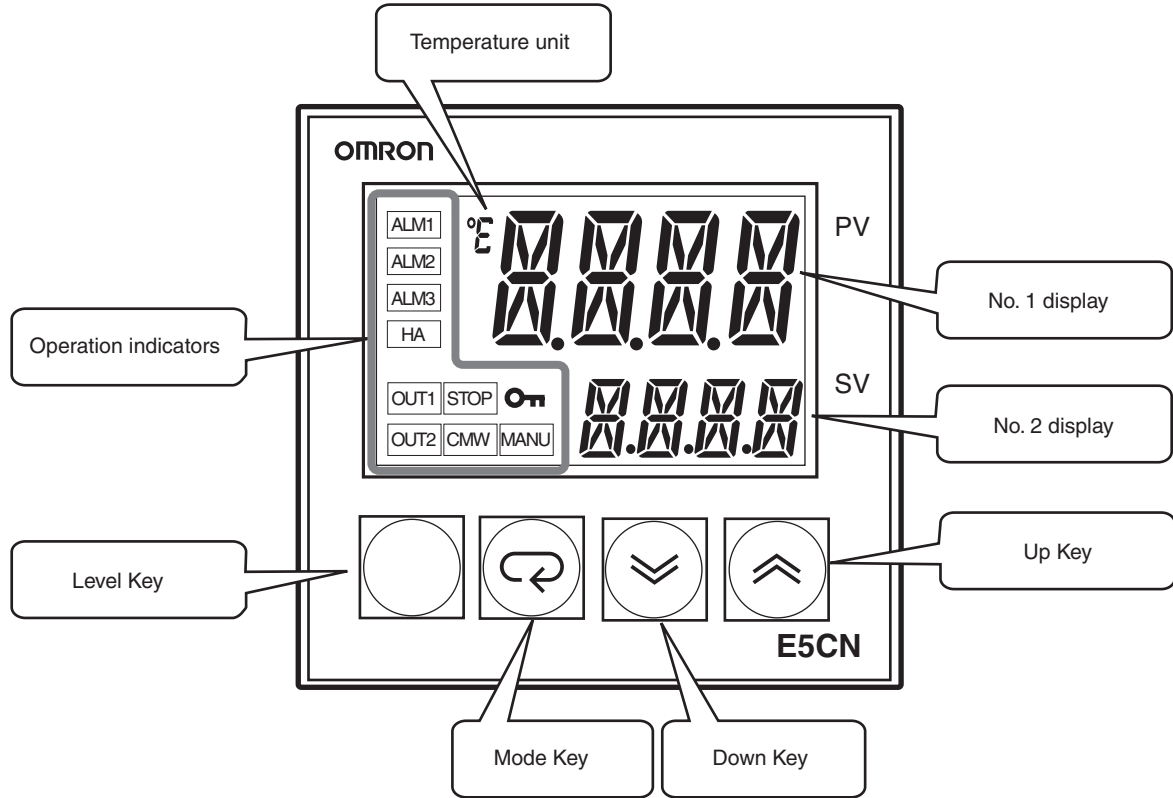

E5AN

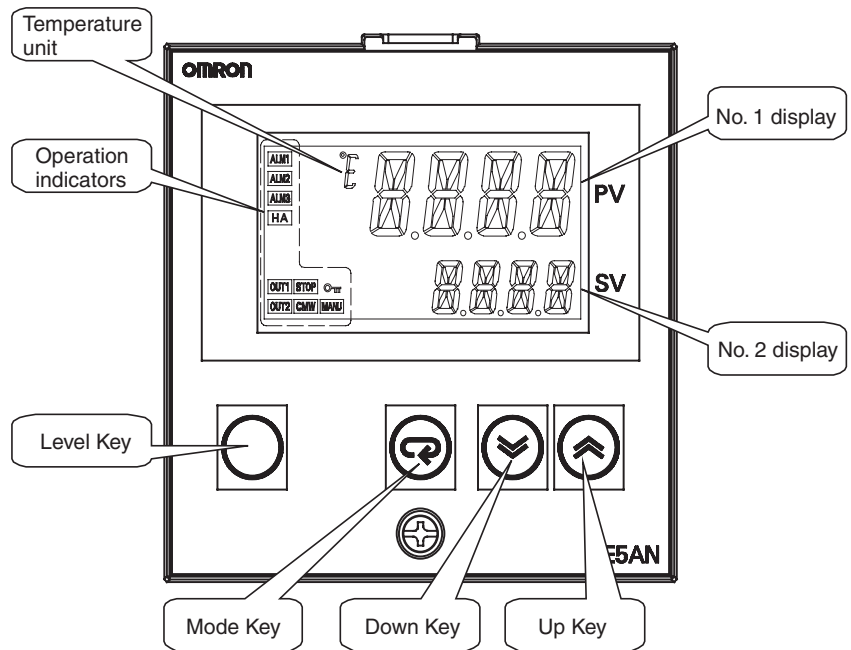

E5EN

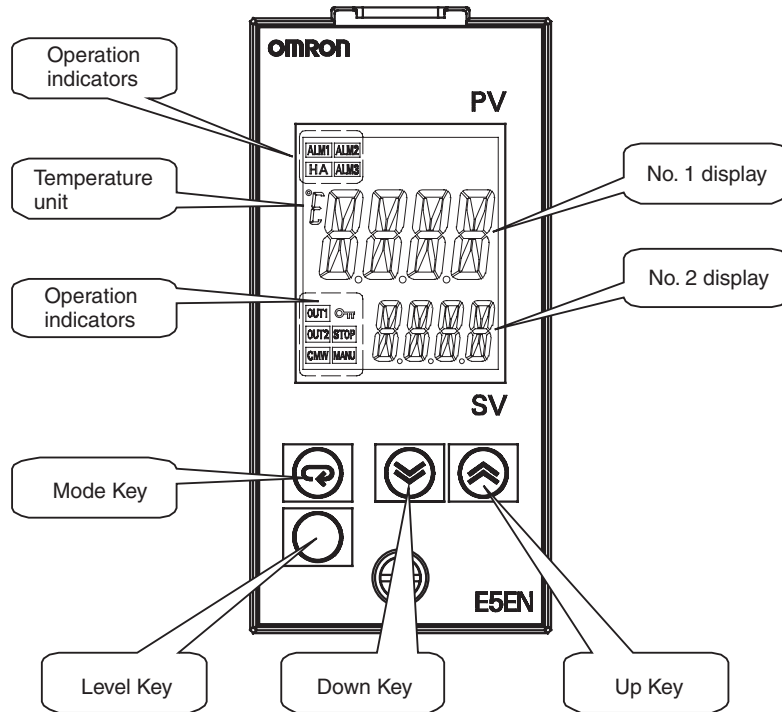

1-1-2 Meanings of Indicators

No. 1 Display

Displays the process value or parameter type.

Lights for approximately one second during startup.

No. 2 Display

Displays the set point, parameter operation read value, or the variable input value.



Lights for approximately one second during startup.

Operation Indicators

1,2,3...

1. ALM1 (Alarm 1)
Lights when the alarm 1 output is ON.
- ALM2 (Alarm 2)
Lights when the alarm 2 output is ON.
- ALM3 (Alarm 3)
Lights when the alarm 3 output is ON.
2. HA (Heater burnout and HS indicator)
Lights when a heater burnout or HS occurs.
3. OUT1, OUT2 (control output 1, control output 2)
Lights when control output 1 or control output 2 is ON.
For a current output, however, OFF for a 0% output only.
4. STOP
Lights when operation is stopped.
During operation, this indicator lights when operation is stopped by an event or by using the RUN/STOP function.
5. CMW (Communications Writing)
Lights when communications writing is enabled and is not lit when it is disabled.
6. MANU (Manual Mode)
Lights when the auto/manual mode is set to manual mode.

7.  (Key)

Lights when settings change protect is ON (i.e., when the  and  keys are disabled by protected status.

Temperature Unit

The temperature unit is displayed when parameters are set to display a temperature. The display is determined by the currently selected “temperature unit” parameter set value. *C* indicates °C and *F* indicates °F.

Flashes during ST operation.

1-1-3 Using the Keys

This section describes the basic functions of the front panel keys.

 **Key**

Press this key to move between setting levels. The setting level is selected in the following order: operation level: adjustment level, initial setting level, communications setting level.

 **Key**

Press this key to change parameters within a setting level.

The parameters can be reversed by holding down the key (moving one per second in reverse order).

 **Key**

Each press of this key increments the value displayed on the No. 2 display or advances the setting. Holding the key down speeds up the incrementation.



 **Key**

Each press of this key decrements values displayed on the No. 2 display or reverses the setting. Holding the key down speeds up the incrementation.

 +  **Keys**

Press these keys to change to the protect level. For details on operations involving holding these keys down simultaneously, refer to *1-3 Setting Level Configuration and Key Operations*. For details on the protect level, refer to *SECTION 5 Parameters*.

 +  **Keys** +  **Keys**

To restrict set value changes (in order to prevent accidental or incorrect operations), these key operations require simultaneously pressing the  key along with  or  key. This applies only to the parameter for the password to move to protect level. (Refer to page 117.)

1-2 I/O Configuration and Main Functions

1-2-1 I/O Configuration

E5CN

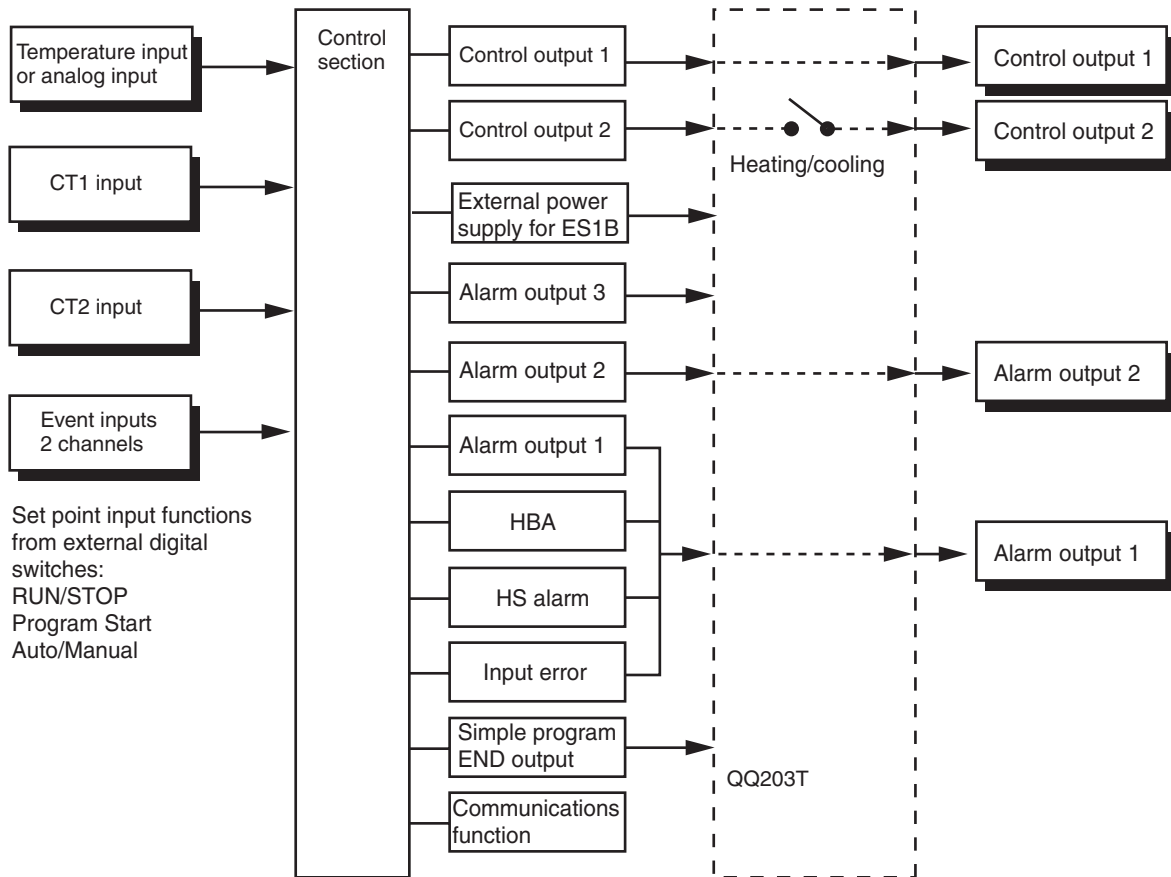

Note Functions can be assigned individually for each output by changing the set values for the control output 1 assignment, the control output 2 assignment, the alarm 1 assignment, and the alarm 2 assignment in the advanced function setting level.

E5CN-U

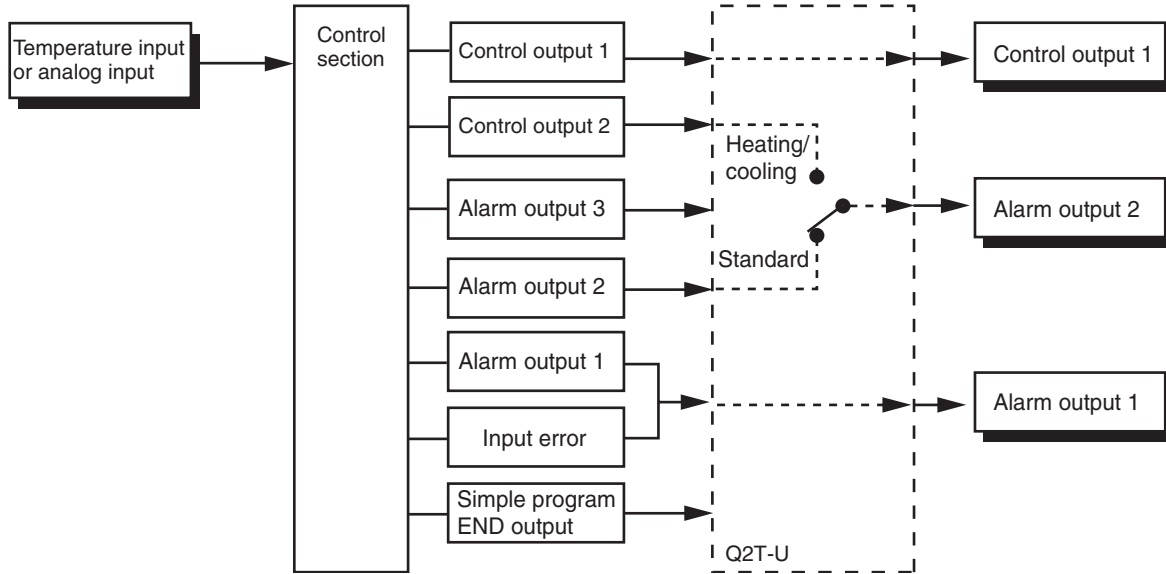

Note Functions can be assigned individually for each output by changing the set values for the control output 1 assignment, the alarm 1 assignment, and the alarm 2 assignment in the advanced function setting level.

Basic model number - -

CompoWay/F compatibility	Blank: Not compatible	FLK: CompoWay/F Compatible
Case color	Blank: Black	W: White gray
Connection type	Blank: Terminal block type	U: Pin type (11 pins)
Input type	T: Multi-input: thermocouple, infrared temperature sensor, platinum resistance thermometer L: Analog input (current input or voltage input)	
Options	H03: Communications and heater burnout/SSR failure detection 03: Communications HB: Heater burnout/SSR failure detection and event inputs B: Event inputs HH03: Communications and 3-phase heater burnout/SSR failure detection Q03: Communications and control output 2 (voltage output) QH: Heater burnout/SSR failure detection and control output 2 (voltage output) QHH: 3-phase heater burnout/SSR failure detection and control output 2 (voltage output) QB: Event input and control output 2 (voltage output) PB: External power supply for ES1B and event inputs PH: External power supply for ES1B and heater burnout/SSR failure detection M: Option Unit can be mounted.	
Alarm output	Blank: No alarm	1: 1 output, 2: 2 outputs
Control output 2	Q: Voltage	
Control output 1	R: Relay, Q: Voltage, C: Current, Y: Long-life relay	

A functional explanation is provided here for illustration, but models are not necessarily available for all possible combinations. Refer to the catalog when ordering.

Examples:

Communications function (with HBA): E5CN-□2H03

Alarm output (with 2 alarm outputs, HBA, and event inputs): E5CN-□2HB

1-2-2 Main Functions

This section introduces the main E5CN/CN-U/AN/EN functions. For details on particular functions and how to use them, refer to *SECTION 3 Basic Operation* and following sections.

Input Sensor Types

- The following input sensors can be connected for temperature input:
 - Thermocouple: K, J, T, E, L, U, N, R, S, B
 - Infrared temperature sensor: ES1B
 - 10 to 70°C, 60 to 120°C, 115 to 165°C, 140 to 260°C
 - Platinum resistance thermometer: Pt100, JPt100
 - Analog input: 0 to 50 mV
- Inputs with the following specifications can be connected for analog input.
 - Current input: 4 to 20 mA DC, 0 to 20 mA DC
 - Voltage input: 1 to 5 VDC, 0 to 5 V DC, 0 to 10 V DC

Control Outputs

- A control output can be relay, voltage, or current output, depending on the model.
- Long-life relay outputs use semiconductors for switching when closing and opening the circuit, thereby reducing chattering and arcing and improving durability. However, if high levels of noise or surge are imposed between the output terminals, short-circuit faults may occasionally occur. If the output becomes permanently shorted, there is the danger of fire due to overheating of the heater. Design safety into the system, including measures to prevent excessive temperature rise and spreading of fire. Take countermeasures such as installing a surge absorber. As an additional safety measure, provide error detection in the control loop. (Use the Loop Break Alarm (LBA) and HS alarm that are provided for the E5□□N.)

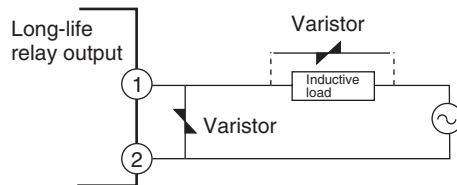

Select a surge absorber that satisfies the following conditions.

Voltage used	Varistor voltage	Surge resistance
100 to 120 VAC	240 to 270 V	1,000 A min.
200 to 240 VAC	440 to 470 V	

- Always connect an AC load to a long-life relay output. The output will not turn OFF if a DC load is connected.
- With the E5CN-□2□□, alarm output 2 is used as control output (cooling) when heating/cooling control is selected. Therefore, use alarm 1 if an alarm is required while using heating/cooling control.
- With the E5AN/E5EN-□3□□, alarm output 3 is used as control output (cooling) when heating/cooling control is selected. Therefore, use alarms 1 and 2 if an alarm is required while using heating/cooling control.

Alarms

- Alarms can be used with the E5CN-□2□□, E5CN-□1□□□U, or E5CN-□2□□□U. Set the alarm classification and alarm value or the alarm's upper and lower limits.
- If necessary, a more comprehensive alarm function can be achieved by setting the standby sequence, alarm hysteresis, close in alarm/open in alarm, and alarm latch parameters.

	<ul style="list-style-type: none"> • When the “input error output” parameter is set to ON, alarm output 1 turns ON when an input error occurs.
Control Adjustment	<ul style="list-style-type: none"> • Optimum PID constants can be set easily by performing AT (auto-tuning) or ST (self-tuning).
Event Inputs	<ul style="list-style-type: none"> • With the E5□N-□□□B, the following functions can be executed using event inputs: switching set points (multi-SP, 4 pts. max.), switching RUN/STOP status, switching between automatic and manual operation, and starting/resetting program.
Heater Burnout and HS Alarms	<ul style="list-style-type: none"> • With the E5□N-□□H□ and E5□N-□□HH□, the heater burnout detection function and the HS alarm function can be used.
Communications Functions	<ul style="list-style-type: none"> • Communications functions utilizing CompoWay/F (See note 1.), SYSWAY (See note 2.), or Modbus (See note 3.) can be used. E5□N-□□□03: RS-485 interface E5□N-□□□01: RS-232C interface (See note 4.)
	<p>Note</p> <p>(1) CompoWay/F is an integrated general-purpose serial communications protocol developed by OMRON. It uses commands compliant with the well-established FINS, together with a consistent frame format on OMRON Programmable Controllers to facilitate communications between personal computers and components.</p> <p>(2) SYSWAY communications do not support alarm 3 output.</p> <p>(3) Modbus is a communications control method conforming to the RTU Mode of Modicon Inc.'s Modbus Protocol.</p> <p>(4) The E5CN and E5CN-U do not support the RS-232C interface.</p>
External Power Supply for ES1B	<p>The E5□N-□□P can be used as the power supply for ES1B Infrared Temperature Sensors.</p> <p>The external power supply for the ES1B cannot be used on the E5CN-C□□ (Current Output Model).</p>

1-3 Setting Level Configuration and Key Operations

Parameters are divided into groups, each called a “level.” Each of the set values (setting items) in these levels is called a “parameter.” The parameters on the E5CN/CN-U/AN/EN are divided into the following eight levels.



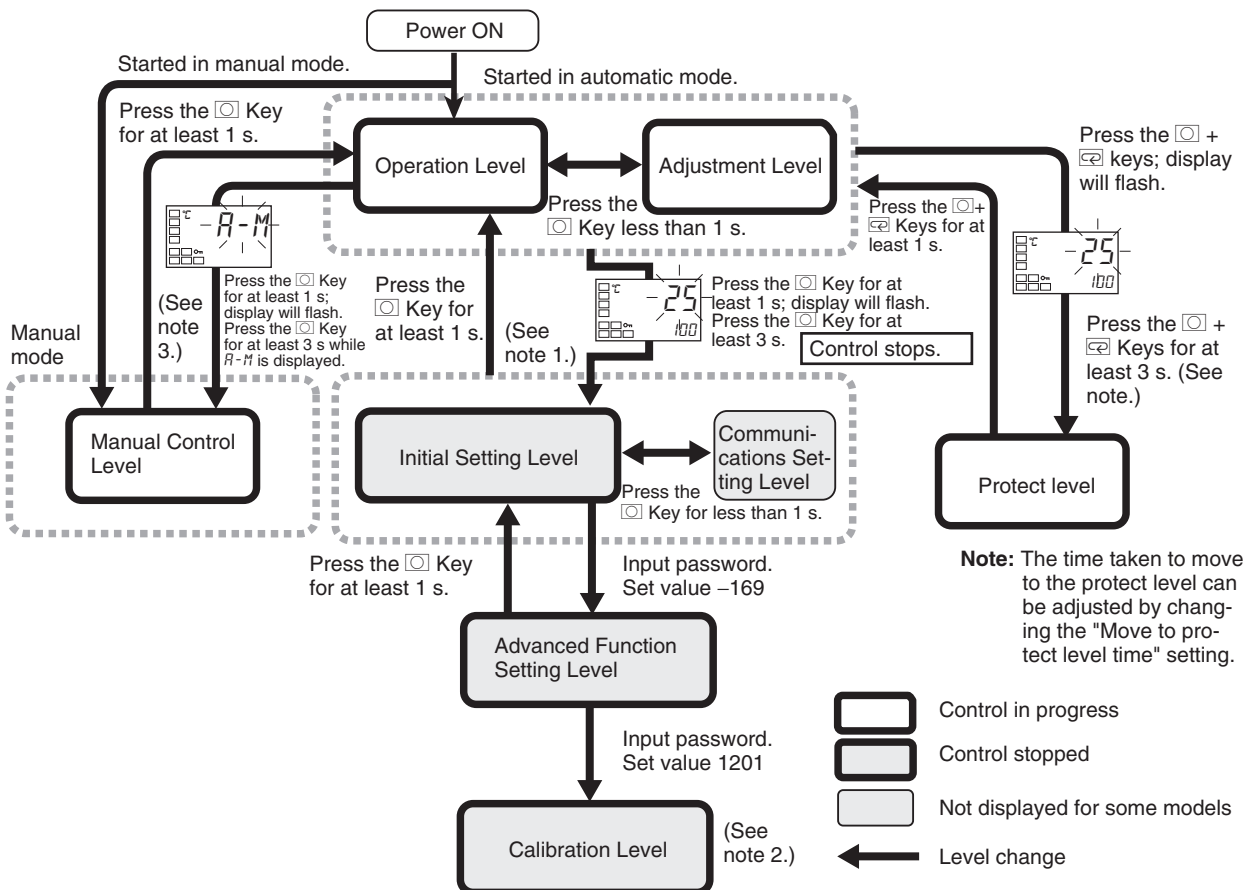





When the power is turned ON, all of the display lights for approximately one second.



- Note**
- (1) Operation level entered for software reset.
 - (2) You cannot move to other levels by operating the keys on the front panel from the calibration level. You must turn OFF the power supply.
 - (3) From the manual control level, key operations can be used to move to the operation level only.

Level	Control in progress	Control stopped
Protect level	Can be set.	---
Operation level	Can be set.	---
Adjustment level	Can be set.	---
Manual control level	Can be set.	---
Initial setting level	---	Can be set.
Advanced function setting level	---	Can be set.
Calibration level	---	Can be set.
Communications setting level	---	Can be set.

Of these levels, the initial setting level, communications setting level, advanced function setting level, and calibration level can be used only when control is stopped. Control outputs are stopped when any of these four levels is selected.

- Protect Level**
- To switch to the protect level from either the operation level or the adjustment level, simultaneously hold down the  and  keys for at least 3 seconds. (See note.) This level is for preventing unwanted or accidental modification of parameters. Protected levels will not be displayed, and so the parameters in that level cannot be modified.
- Note** The key pressing time can be changed in “move to protect level move” parameter (advanced function level).
- Operation Level**
- The operation level is displayed when the power is turned ON. You can move to the protect level, initial setting level, or adjustment level from this level.
 - Normally, select this level during operation. While operation is in progress, items such as the PV and manipulated variable (MV) can be monitored, and the set points, alarm values, and alarm upper and lower limits can be monitored and changed.
- Adjustment Level**
- To move to the adjustment level, press the  key once (for less than 1 s).
 - This level is for entering set values and offset values for control. In addition to AT (auto-tuning), communications write enable/disable switching, hysteresis settings, multi-SP settings, and input offset parameters, it includes HBA, HS alarm, and PID constants. From the adjustment level, it is possible to move to the top parameter of the initial setting level, protect level, or operation level.
- Manual Control Level**
- When the  key is pressed for at least 3 seconds from the operation level's auto/manual switching display, the manual control level will be displayed. (The MANU indicator will light.)
 - This is the level for changing the MV in manual mode.
 - To return to the operation level, press the  key for at least one second.
- Initial Setting Level**
- To move to the initial setting level from the operation level or the adjustment level, press the  key for at least 3 seconds. The PV display flashes after one second. This level is for specifying the input type and selecting the control method, control period, setting direct/reverse action, and setting the alarm types. You can move to the advanced function setting level or communications setting level from this level. To return to the operation level, press the  key for at least one second. To move to the communications setting level, press the  key for less than one second. (When moving from the initial setting level to the operation level, all the indicators will light.)
- Note** Pressing the  key for at least 3 seconds in the operation level's auto/manual switching display will move to the manual control level, and not the initial setting level.
- Advanced Function Setting Level**
- To move to the advanced function setting level, set the “initial setting/communications protect” parameter in the protect level to 0 and then, in the initial setting level, input the password (–169).
 - From the advanced function setting level, it is possible to move to the calibration level or to the initial setting level.

Communications Setting Level

- This level is for setting the display auto-return time, event input assignments, standby sequence, and alarm hysteresis, and it is the level for moving to the user calibration.
- To move to the communications setting level from the initial setting level, press the  key once (for less than 1 s). When using the communications function, set the communications conditions in this level. Communicating with a personal computer (host computer) allows set points to be read and written, and manipulated variables (MV) to be monitored.

Calibration Level





- To move to the calibration level, input the password (1201) from the advanced setting level. The calibration level is for offsetting error in the input circuit.
- You cannot move to other levels from the calibration level by operating the keys on the front panel. To cancel this level, turn the power OFF then back ON again.

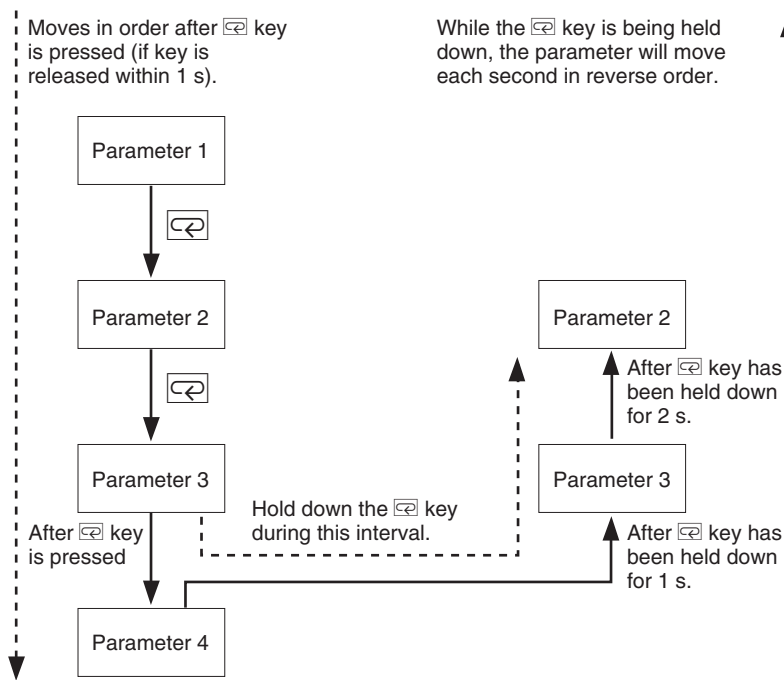

1-3-1 Selecting Parameters

- Within each level, the parameter is changed in order (or in reverse order) each time the  key is pressed. (In the calibration level, however, parameters cannot be changed in reverse order.) For details, refer to *SECTION 5 Parameters*.







1-3-2 Fixing Settings

- If you press the  key at the final parameter, the display returns to the top parameter for the current level.
- To change parameter settings, specify the setting using the  or  key, and either leave the setting for at least two seconds or press the  key. This fixes the setting.
- When another level is selected after a setting has been changed, the contents of the parameter prior to the change are fixed.

- When you turn the power OFF, you must first fix the settings (by pressing the  key). The settings are sometimes not changed by merely pressing the  or  keys.

1-4 Communications Function

The E5CN/AN/EN is provided with a communications function that enables parameters to be checked and set from a host computer. If the communications function is required, use a model that has that function (E5□N-□□□03 and E5AN/EN-□□□01). For details on the communications function, see the separate *Communications Functions User's Manual*. Use the following procedure to move to the communications setting level.

- 1,2,3...**
1. Press the  key for at least three seconds to move from the operation level to the initial setting level.
 2. Press the  key for less than one second to move from the initial setting level to the communications setting level.
 3. Select the parameters as shown below by pressing the  key.
 4. Press the  or  key to change the parameter setting.

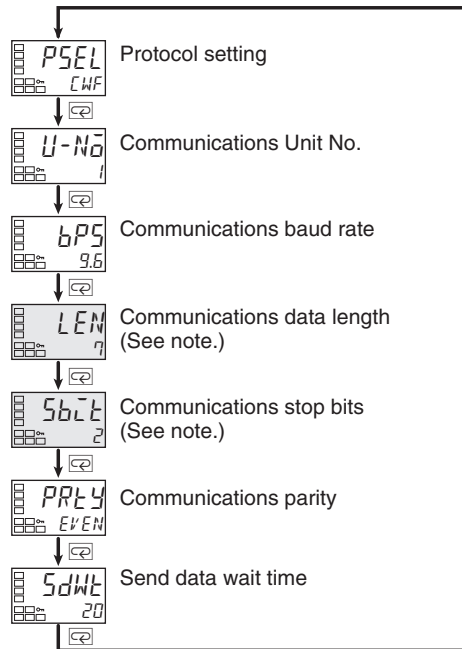

Note The “protocol setting” parameter is displayed only when CompoWay/F communications are being used.

Setting Communications Data

Match the communications specifications of the E5CN/AN/EN and the host computer. If a 1:N connection is being used, ensure that the communications specifications for all devices in the system (except the communications Unit No.) are the same.

Parameter	Symbol	Setting (monitor) value	Selection symbols	Default	Unit
Protocol setting	<i>PSEL</i>	CompoWay/F (SYSWAY), Modbus	<i>WF, Mod</i>	CompoWay/F (SYSWAY)	None
Communications Unit No.	<i>U-N\bar{o}</i>	0 to 99		1	None
Communications baud rate	<i>bPS</i>	1.2, 2.4, 4.8, 9.6, 19.2, 38.4	<i>1.2, 2.4, 4.8, 9.6, 19.2, 38.4</i>	9.6	kbit/s
Communications data length	<i>LEN</i>	7, 8		7	Bits
Communications stop bits	<i>St\bar{b}t</i>	1, 2		2	Bits
Communications parity	<i>PR\bar{P}</i>	None, Even, Odd	<i>N\bar{o}NE, EVEN, \bar{o}dd</i>	Even	None
Send data wait time	<i>Sd\bar{w}E</i>	0 to 99		20	ms

SECTION 2

Preparations

This section describes the work required to prepare the E5CN and E5CN-U Digital Temperature Controllers for operation, including installation and wiring.

2-1	Installation	16
2-1-1	Dimensions	16
2-1-2	Panel Cutout	17
2-1-3	Mounting.	18
2-1-4	Removing the Temperature Controller from the Case	20
2-2	Wiring Terminals.	21
2-2-1	Terminal Arrangement	21
2-2-2	Precautions when Wiring	22
2-2-3	Wiring.	23
2-3	Using the Support Software Port.	30

2-1 Installation

2-1-1 Dimensions

Unit: mm

E5CN

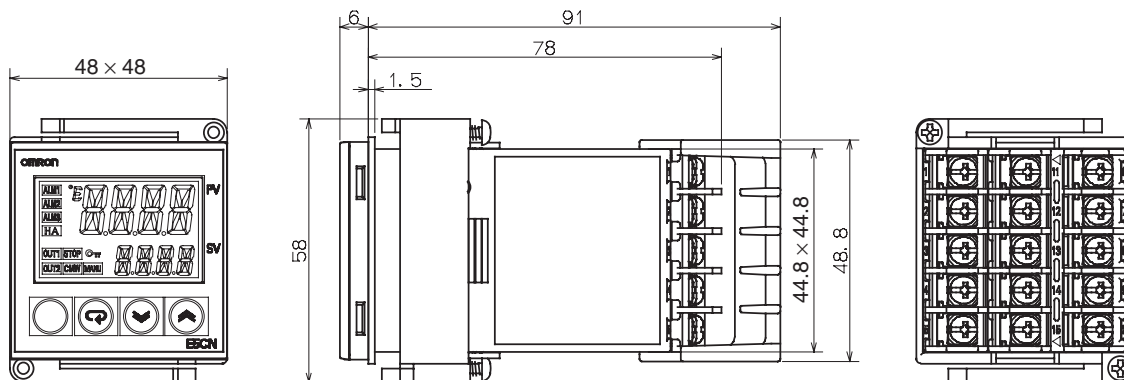

E5CN-U

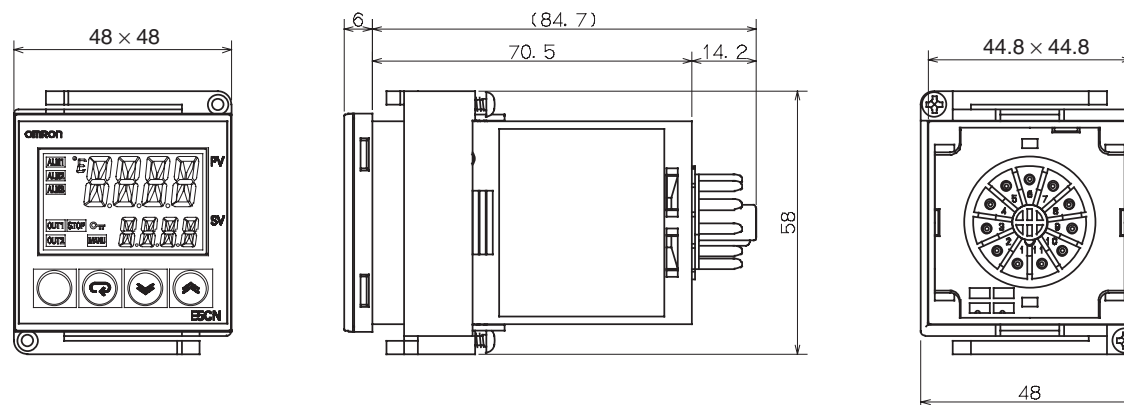

E5AN

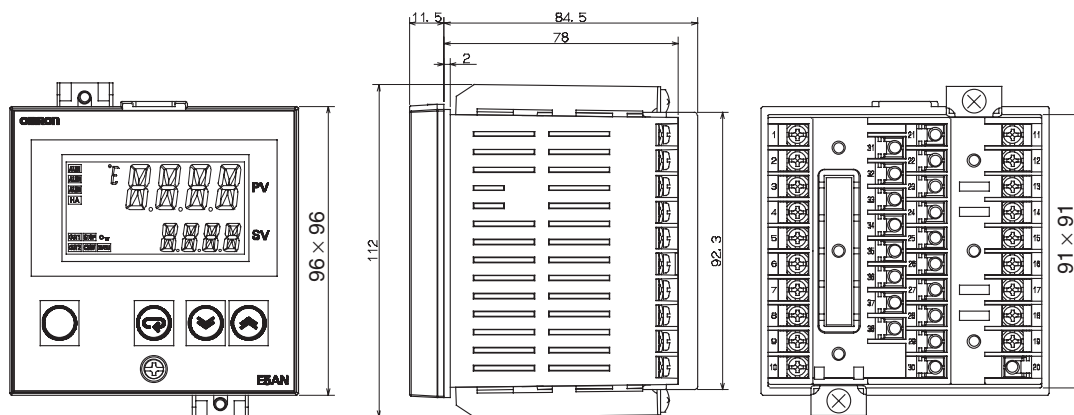

E5EN

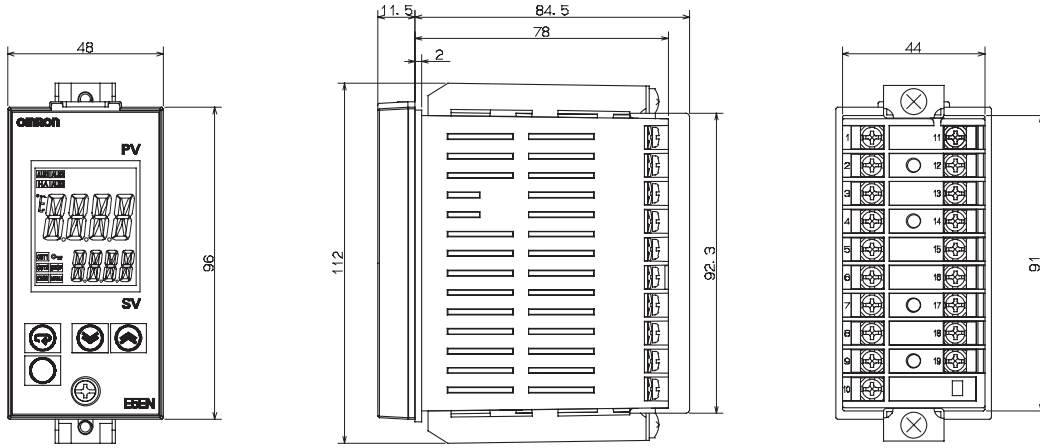

2-1-2 Panel Cutout

Unit: mm

E5CN/CN-U

Individual Mounting

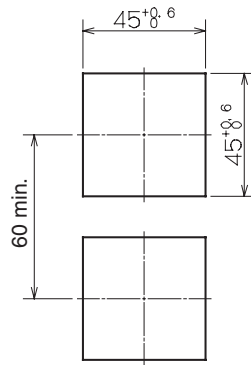

Group Mounting

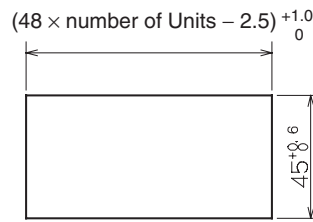

E5AN

Individual Mounting

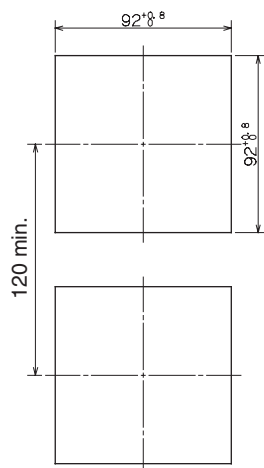

Group Mounting

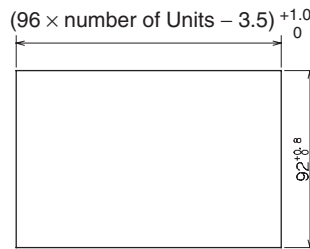

E5EN

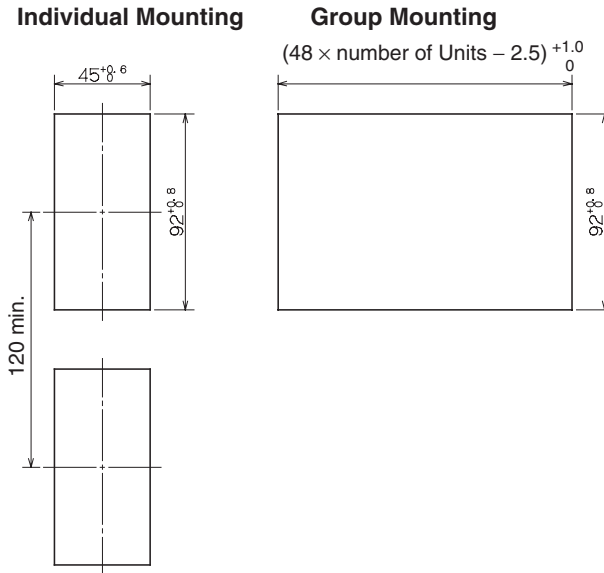

- Waterproofing is not possible when group mounting several Controllers.
- The recommended panel thickness is 1 to 5 mm for E5CN/E5CN-U, and 1 to 8 mm for E5AN/E5EN.
- Units must not be closely mounted vertically. (Observe the recommended mounting space limits.)
- When group mounting several Controllers, ensure that the surrounding temperature does not exceed the ambient operating temperature listed in the specifications.

2-1-3 Mounting

For the Wiring Socket, purchase the P2CF-11 or PG3A-11 separately.

E5CN/CN-U

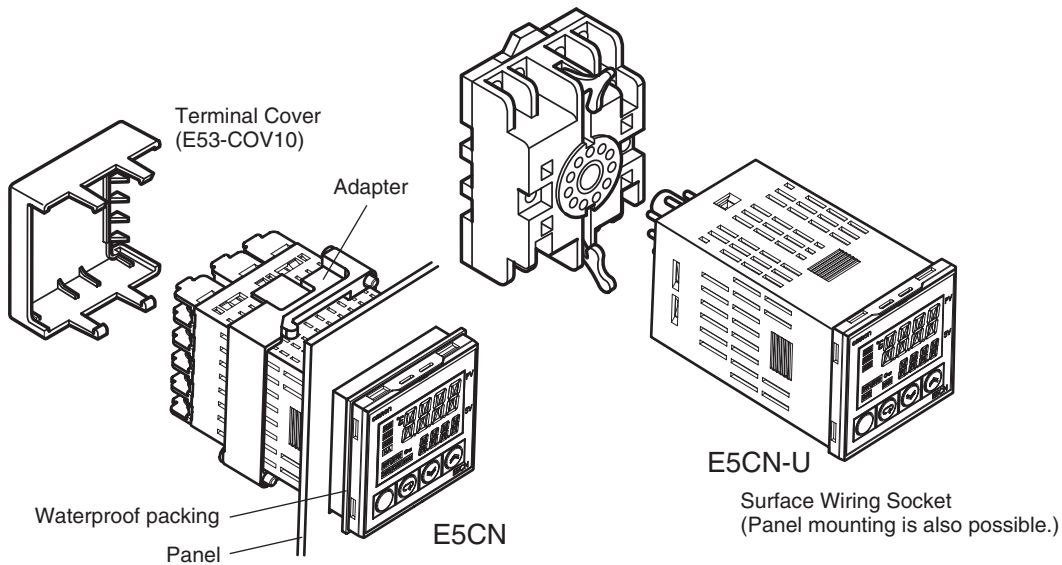

Mounting to the Panel

- 1,2,3...
1. For waterproof mounting, waterproof packing must be installed on the Controller. Waterproofing is not possible when group mounting several Controllers. Waterproof packing is not necessary when there is no need for the waterproofing function. There is no waterproof packing included with the E5CN-U.
 2. Insert the E5CN/E5CN-U into the mounting hole in the panel.
 3. Push the adapter from the terminals up to the panel, and temporarily fasten the E5CN/E5CN-U.
 4. Tighten the two fastening screws on the adapter. Alternately tighten the two screws little by little to maintain a balance. Tighten the screws to a torque of 0.29 to 0.39 N-m.

Mounting the Terminal Cover

For the E5CN, make sure that the “UP” mark is facing up, and then fit the terminal cover into the holes on the top and bottom.

E5AN/EN

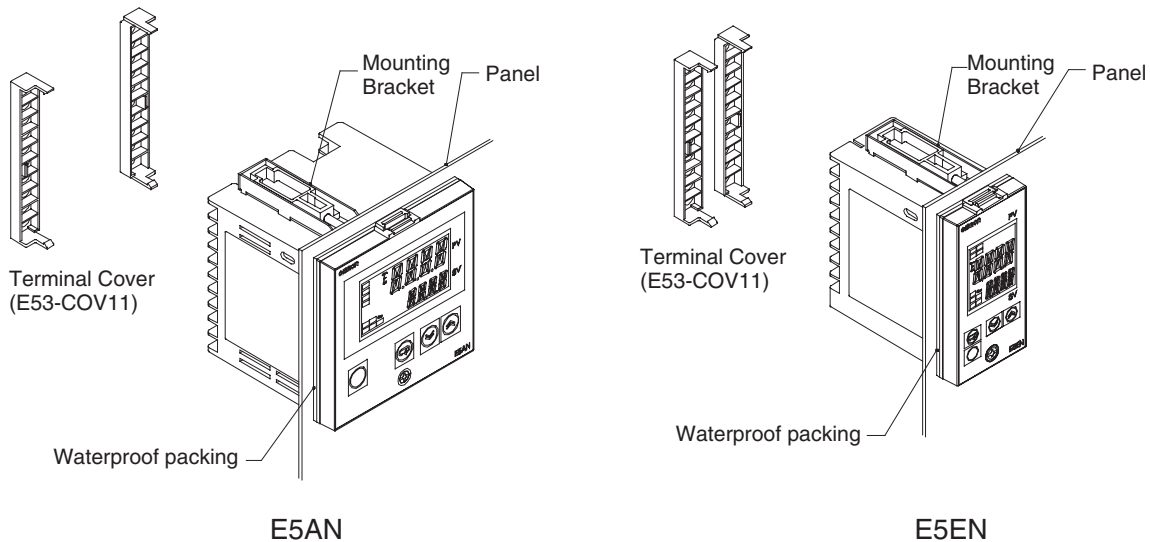

Mounting to the Panel

- 1,2,3...
1. For waterproof mounting, waterproof packing must be installed on the Controller. Waterproofing is not possible when group mounting several Controllers. Waterproof packing is not necessary when there is no need for the waterproofing function.
 2. Insert the E5AN/E5EN into the square mounting hole in the panel (thickness: 1 to 8 mm). Attach the Mounting Brackets provided with the product to the mounting grooves on the top and bottom surfaces of the rear case.
 3. Use a ratchet to alternately tighten the screws on the top and bottom Mounting Brackets little by little to maintain balance, until the ratchet turns freely.

Mounting the Terminal Cover

Fit the E53-COV11 Terminal Cover over the upper hook. Mount it in the direction shown in the above diagram. If the terminal cover is mounted in the opposite direction, proper mounting of the fixtures may not be possible.

2-1-4 Removing the Temperature Controller from the Case

The Temperature Controller can be removed from the case to perform maintenance without removing the terminal leads. This is possible for only the E5CN, E5AN, and E5EN, and not for the E5CN-U. Check the specifications of the case and Temperature Controller before removing the Temperature Controller from the case.

E5CN

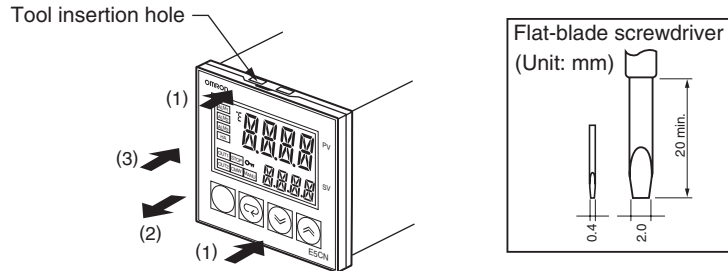

- 1,2,3...**
1. Insert the tool into the two tool insertion holes (one on the top and one on the bottom) and release the hooks.
 2. Insert the tool in the gap between the front panel and rear case, and pull out the front panel slightly. Hold the top and bottom of the front panel and carefully pull it out toward you, without applying unnecessary force.
 3. When inserting the E5CN, check to make sure that the sealing rubber is in place and push the E5CN toward the rear case until it snaps into position. While pushing the E5CN into place, push down on the hooks on the top and bottom surfaces of the rear case so that the hooks are securely locked in place. Be sure that electronic components do not come into contact with the case.

E5AN/EN

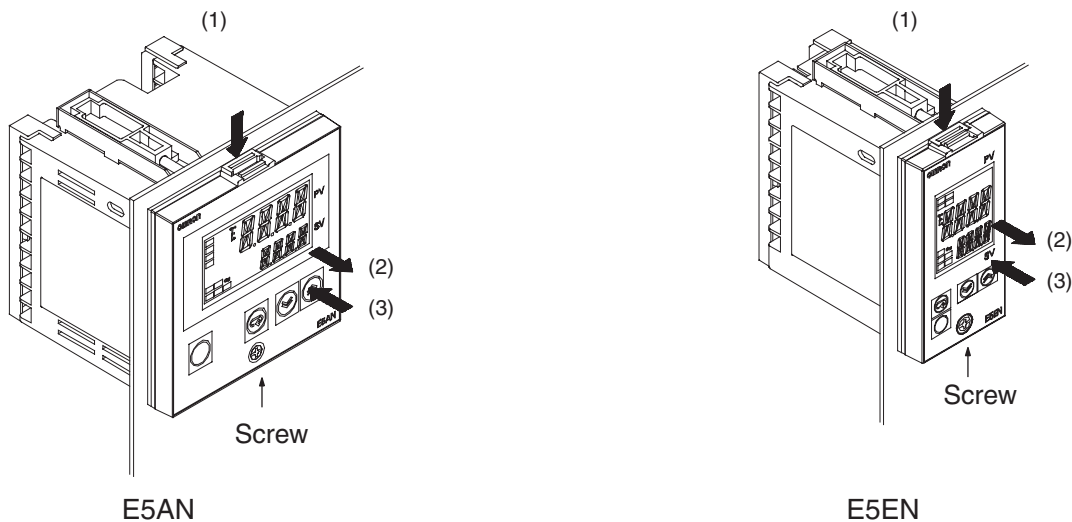

Prepare a Phillips screwdriver suitable for the screw on the front panel to remove the Temperature Controller.

- 1,2,3...**
1. Push on the hooks on the top of the front panel, and at the same time, turn the Phillips screwdriver to the left to loosen the screw on the bottom of the front panel.
 2. Pull out the front panel gripping both sides. Be sure not to impose excessive force on the panel.

- When inserting the E5AN/E5EN Temperature Controller, check to make sure that the sealing rubber is in place. Then, while pushing the front panel into place, turn the Phillips screwdriver to the right in the opposite direction used when removing the panel to tighten the screws on the top and bottom surfaces (tightening torque: 0.3 to 0.5 N·m). Make sure that electronic components do not come into contact with the case.

2-2 Wiring Terminals

2-2-1 Terminal Arrangement

E5CN

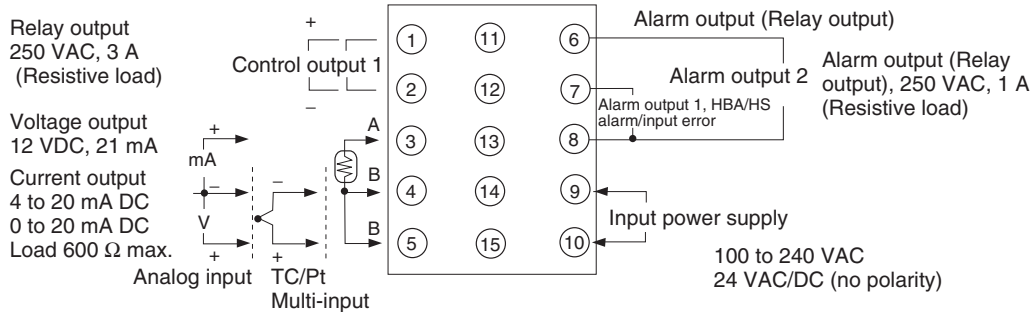

E53-CN03N
Communications/
CT

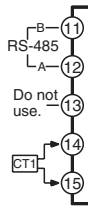

E53-CN03N
Event inputs/
CT

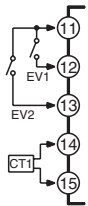

E53-CN03N
Communications

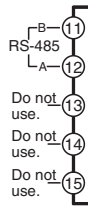

E53-CN03N
Event inputs

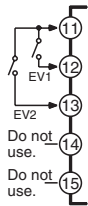

E53-CN03N
Communications/
Two CTs

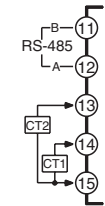

E53-CN03N
Communications/
Control output 2

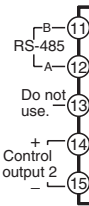

Attach the appropriate terminal labels.

E53-CN03N
Control output 2/
CT

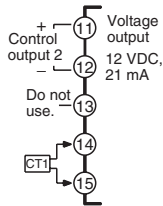

E53-CN03N
Control output 2/
Two CTs

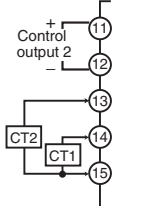

E53-CN03N
Event inputs/
Control output 2

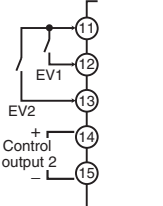

E53-CN03N
Event inputs/
External power
supply for ES1B

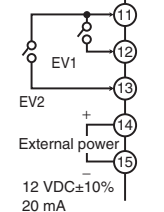

E53-CN03N
External power supply
for ES1B/CT

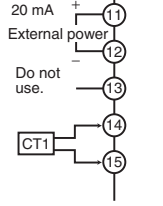

*The external power supply for ES1B cannot be used on the E5CN-C (Current Output Model).

E5CN-U

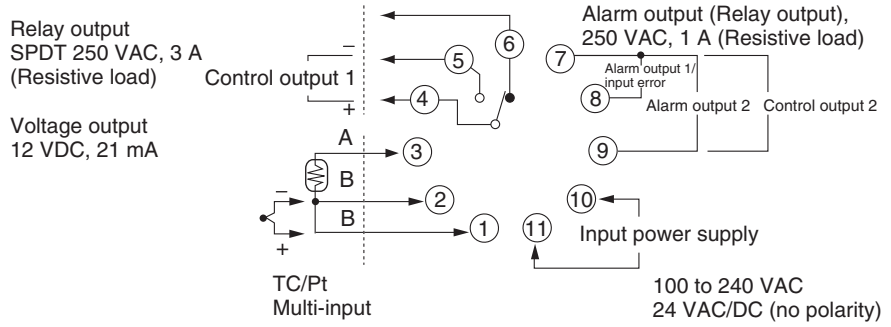

Note For the Wiring Socket, purchase the P2CF-11 or PG3A-11 separately.

E5AN/EN

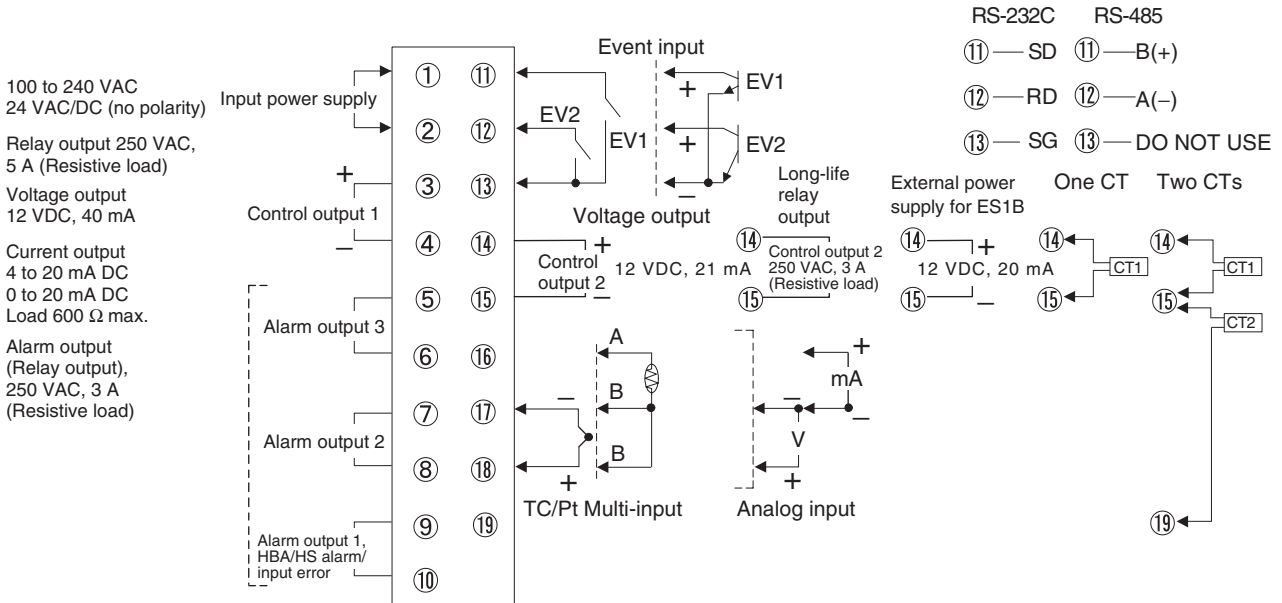

2-2-2 Precautions when Wiring

- Separate input leads and power lines in order to prevent external noise.
- Use AWG24 (cross-sectional area: 0.205 mm²) to AWG14 (cross-sectional area: 2.081 mm²) twisted-pair cable (stripping length: 5 to 6 mm).
- Use crimp terminals when wiring the terminals.
- Tighten the terminal screws to a torque of 1.13 to 1.36 N·m, except for the E5CN-U, which is 0.5 N·m.
- Use the following types of crimp terminals for M3.5 screws.

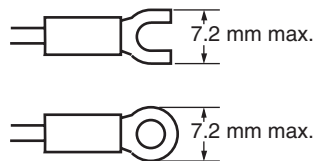

Note Do not remove the terminal block. Doing so will result in malfunction or failure.

2-2-3 Wiring

In the connection diagrams, the left side of the terminal numbers represents the inside of the Controller and the right side represents the outside.

Power supply

- With the E5CN, connect to terminals 9 and 10; with the E5CN-U, connect to pins 10 and 11; with the E5AN and E5EN, connect pins 1 and 2. The following table shows the specifications.

Input power supply	E5CN	E5CN-U	E5AN/EN
100 to 240 VAC, 50/60 Hz	7.5 VA	6 VA	11 VA/10 VA
24 VAC, 50/60 Hz	5 VA	3 VA	5.5 VA
24 VDC (no polarity)	3 W	2 W	4 W

- Standard insulation is applied between the input power supply and the I/O sections. If reinforced insulation is required, connect the input and output terminals to a device without any exposed current-carrying parts or to a device with standard insulation suitable for the maximum operating voltage of the power supply I/O section.
- In models that have an “R” at the end of the lot number, reinforced insulation is applied between the input power supply, the relay outputs, and other terminals.

Input

- Make the connections as shown below, using terminals 3 to 5 for the E5CN, pins 1 to 3 for the E5CN-U, and pins 16 and 18 for the E5AN/EN, and matching the input types.

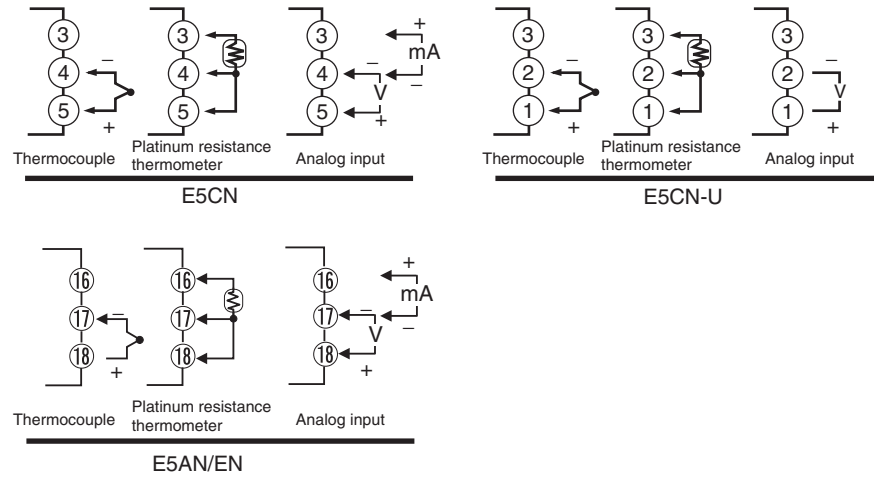

Control Output 1

- Outputs are sent from terminals 1 and 2 with the E5CN, from pins 4 to 6 with the E5CN-U, and from pins 3 and 4 with the E5AN/EN. The following diagrams show the available outputs and their internal equalizing circuits.

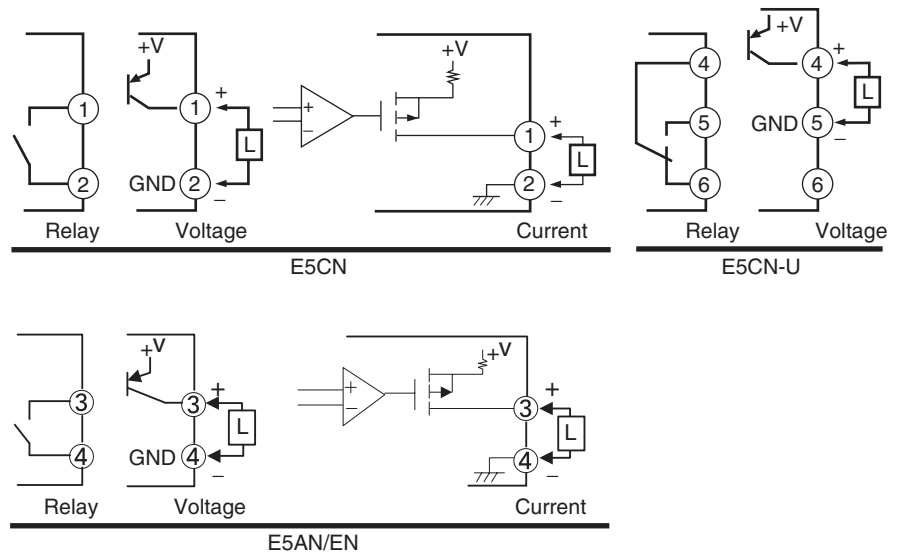

- The following table shows the specifications for each output type.

E5CN/CN-U

Output type	Specifications
Relay	250 VAC, 3 A (resistive load), electrical durability: 100,000 operations
Long-life relay	250 VAC, 3 A (resistive load), electrical durability: 1,000,000 operations
Voltage (PNP)	PNP type, 12 VDC $\pm 15\%$, 21 mA (with short-circuit protection)
Current	DC 4 to 20 mA/DC 0 to 20 mA, resistive load: 600 Ω max. Resolution: Approx. 2,700

E5AN/EN

Output type	Specifications
Relay	250 VAC, 5 A (resistive load), electrical durability: 100,000 operations
Voltage (PNP)	PNP type, 12 VDC $+15\%/-20\%$, 40 mA (with short-circuit protection)
Current	DC 4 to 20 mA/DC 0 to 20 mA, resistive load: 600 Ω max. Resolution: Approx. 2,700

- Always connect an AC load to a long-life relay output. The output will not turn OFF if a DC load is connected.
- A voltage output (control output) is not electrically isolated from the internal circuits. When using a grounding thermocouple, do not connect any of the control output terminals to the ground. If control output terminals are connected to the ground, errors will occur in the measured temperature values as a result of leakage current.
- Control outputs 1 and 2 (voltage outputs) are not isolated. For E5AN/EN, however, the voltage output (control output 2) is isolated.
- Long-life relay outputs use semiconductors for switching when closing and opening the circuit, thereby reducing chattering and arcing and improving durability. However, if high levels of noise or surge are imposed between the output terminals, short-circuit faults may occasionally occur. If the output becomes permanently shorted, there is the danger of fire due to overheating of the heater. Design safety into the system, including

measures to prevent excessive temperature rise and spreading of fire. Take countermeasures such as installing a surge absorber. As an additional safety measure, provide error detection in the control loop. (Use the Loop Break Alarm (LBA) and HS alarm that are provided for the E5□N.)

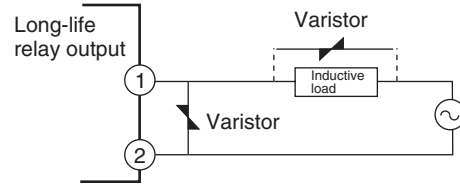

Select a surge absorber that satisfies the following conditions.

Voltage used	Varistor voltage	Surge resistance
100 to 120 VAC	240 to 270 V	1,000 A min.
200 to 240 VAC	440 to 470 V	

Control Output 2

- Outputs are sent from terminals 11, 12, 14, and 15 with the E5CN, and from pins 14 and 15 with the E5AN/EN. The following diagrams show the available outputs and their internal equalizing circuits.

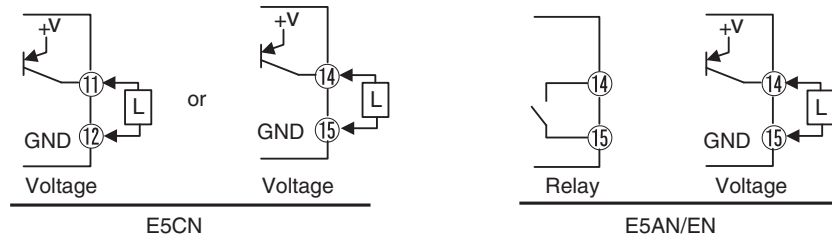

- The following table shows the specifications for each output type.

E5CN/CN-U

Output type	Specifications
Voltage (PNP)	PNP type, 12 VDC ±15%, 21 mA (with short-circuit protection)

E5AN/EN

Output type	Specifications
Long-life relay	250 VAC, 3 A (resistive load), electrical durability: 1,000,000 operations
Voltage (PNP)	PNP type, 12 VDC +15%/-20%, 21 mA (with short-circuit protection)

- Always connect an AC load to a long-life relay output. The output will not turn OFF if a DC load is connected.
- A voltage output (control output) is not electrically isolated from the internal circuits. Therefore, when using a grounding thermocouple, do not connect any of the control output terminals to the ground. If control output terminals are connected to the ground, errors will occur in the measured temperature values as a result of leakage current. With E5AN/EN, however, voltage output (control output 2) is functionally isolated from the internal circuits.
- The control output 2 of E5CN is a voltage output only, and outputs across terminals 11(+) and 12(-), or 14(+) and 15(-).
- Control outputs 1 and 2 (voltage outputs) are not isolated.

- Long-life relay outputs use semiconductors for switching when closing and opening the circuit, thereby reducing chattering and arcing and improving durability. However, if high levels of noise or surge are imposed between the output terminals, short-circuit faults may occasionally occur. If the output becomes permanently shorted, there is the danger of fire due to overheating of the heater. Design safety into the system, including measures to prevent excessive temperature rise and spreading of fire. Take countermeasures such as installing a surge absorber. As an additional safety measure, provide error detection in the control loop. (Use the Loop Break Alarm (LBA) and HS alarm that are provided for the E5□N.)

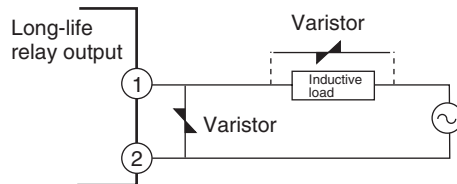

Select a surge absorber that satisfies the following conditions.

Voltage used	Varistor voltage	Surge resistance
100 to 120 VAC	240 to 270 V	1,000 A min.
200 to 240 VAC	440 to 470 V	

Alarm Outputs 1, 2, and 3

- On the E5CN-□2□□□, alarm output 1 (ALM1) is output across terminals 7 and 8, and alarm output 2 (ALM2) is output across terminals 6 and 8.
- On the E5CN-□1□□□U, alarm output 1 (ALM1) is output across terminals 7 and 8.
- On the E5CN-□2□□□U, alarm output 1 (ALM1) is output across terminals 7 and 8, and alarm output 2 (ALM2) is output across terminals 7 and 9.
- On the E5AN/EN-□3□□□, alarm output 1 (ALM1) is output across terminals 9 and 10, alarm output 2 (ALM2) is output across terminals 7 and 8, and alarm output 3 (ALM3) is output across terminals 5 and 6.
- When the “input error output” parameter is set to ON, alarm output 1 turns ON when an input error occurs.
- When the HBA or the HS alarm is used with the E5CN-□□H□ or the E5CN-□□HH□, alarms are output across terminals 7 and 8.
- When the HBA or the HS alarm is used with the E5CN-□□H□□, alarms are output across terminals 9 and 10.
- On the E5CN and E5CN-U, when heating/cooling control is used, alarm output 2 becomes control output (cooling).
- On the E5AN and E5EN, when heating/cooling control is used, alarm output 3 becomes control output (cooling).
- For models that have a heater burnout alarm, an OR of alarm output 1 and the HBA/HS alarm is output. If ALM1 is to be used for HBA only, set the alarm 1 type to 0 and do not use alarm output 1.
- The following diagrams show the internal equalizing circuits for alarm outputs 1, 2, and 3.

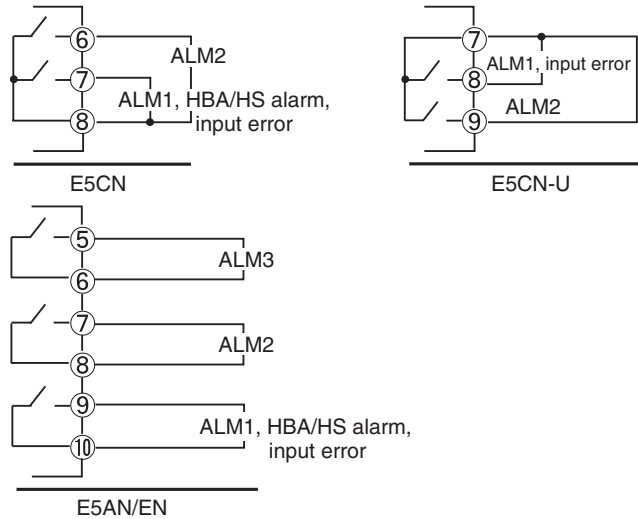

- The relay specifications are as follows:

E5CN/CN-U	SPST-NO 250 VAC 1 A
E5AN/EN	SPST-NO 250 VAC 3 A

CT Inputs

- When the HBA or the HS alarm is to be used with the E5CN-□□H□ or the E5CN-□□HH□, connect a current transformer (CT) across terminals 14 and 15 or terminals 13 and 15 (no polarity).
- When the HBA or the HS alarm is to be used with the E5AN/EN-□□H□ or E5AN/EN-□□HH□, connect a current transformer (CT) across terminals 14 and 15 or terminals 15 and 19 (no polarity).

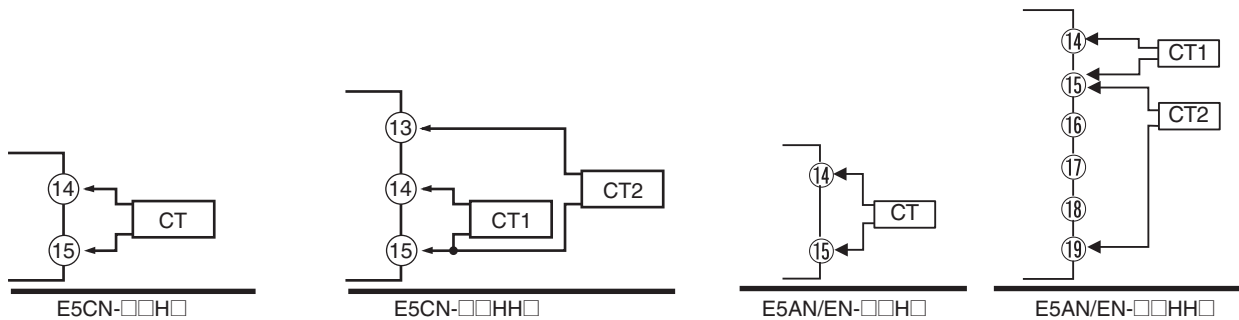

Event Inputs

- When event inputs are to be used with the E5□N-□□□B, connect to terminals 11 to 13.

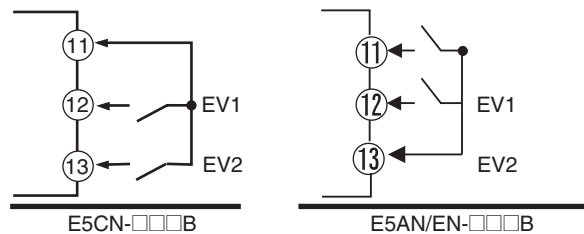

- Use event inputs under the following conditions:
- The outflow current is approximately 7 mA.

Contact input	ON: 1 kΩ max., OFF: 100 kΩ min.
No-contact input	ON: Residual voltage 1.5 V max.; OFF: Leakage current 0.1 mA max.

Polarities during no-contact input are as follows:

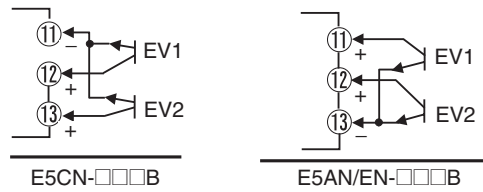

Communications

RS-485

- When communications are to be used with the E5□N-□□□03, connect communications cable across terminals 11 and 12.

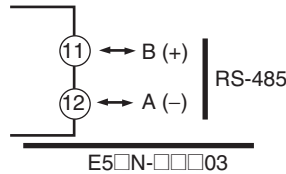

Specify both ends of the transmission path including the host computer as end nodes (that is, connect terminators to both ends).
The minimum terminal resistance is 54 Ω.

Communications Unit Connection Diagram

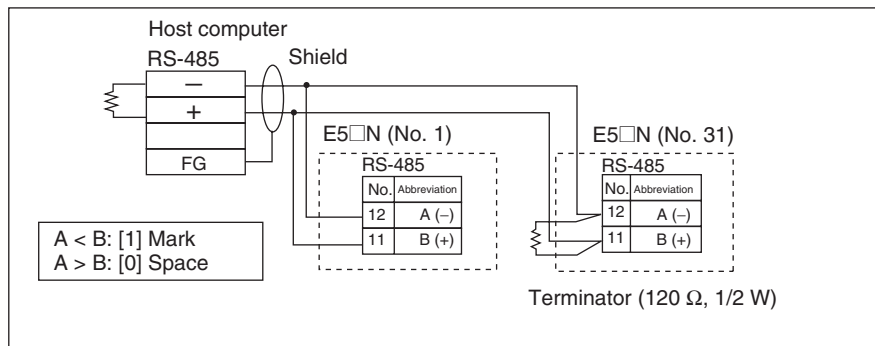

- The RS-485 connection can be either one-to-one or one-to-N. A maximum of 32 Units (including the host computer) can be connected in one-to-N systems. The maximum total cable length is 500 m. Use AWG24 (cross-sectional area: 0.205 mm²) to AWG14 (cross-sectional area: 2.081 mm²) shielded twisted-pair cable.

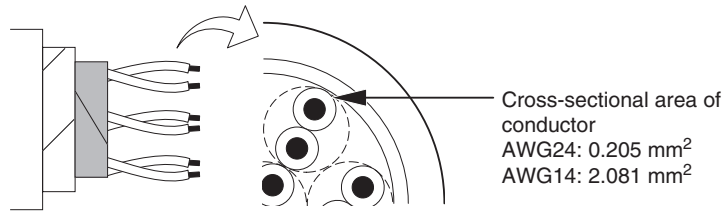

RS-232C (E5AN/EN Only)

- When communications are to be used with the E5AN/EN-□□□01□, connect communications cable across terminals 11 to 13.

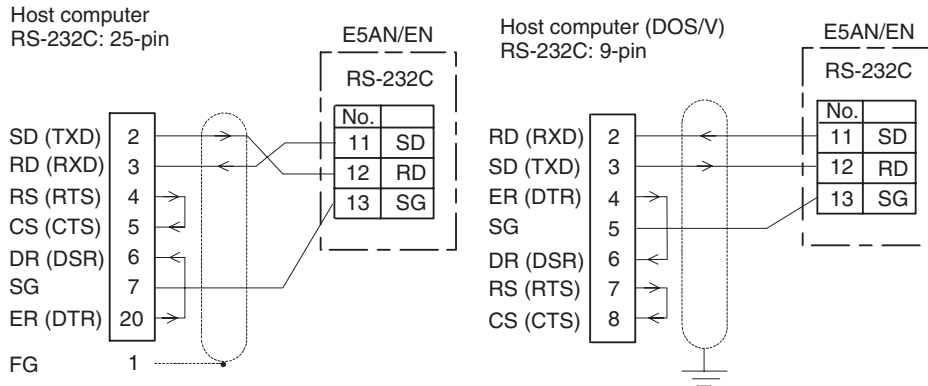
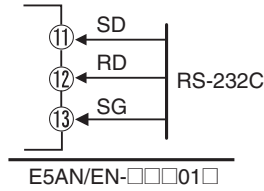

- A 1:1 connection is used. The maximum cable length is 15 m. To extend the transmission path, use the OMRON Z3R RS-232C Optical Interface.
- Use AWG24 (cross-sectional area: 0.205 mm²) to AWG14 (cross-sectional area: 2.081 mm²) shielded twisted-pair cable.

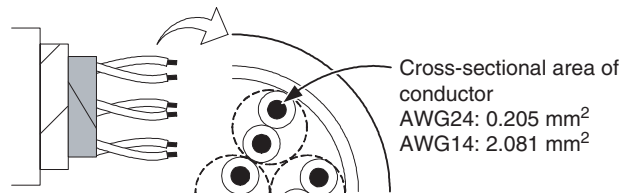

External Power Supply for ES1B

- Connect terminals 11 and 12 when using the E5CN-□□PH as the external power supply for the ES1B.
- Connect terminals 14 and 15 when using the E5CN-□□PB as the external power supply for the ES1B.
- Connect terminals 14 and 15 when using the E5AN/EN-□□P as the external power supply for the ES1B.

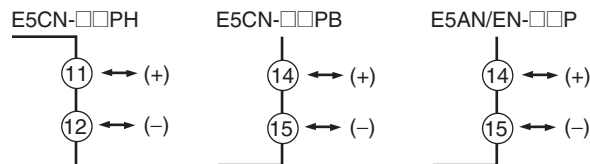

- The following table provides the specifications of the external power supply for ES1B.

Output voltage	12 VDC ±10%
Output current	20 mA max.

Note Contact your OMRON representative for information on using the external power supply for ES1B for other applications. The external power supply for ES1B cannot be used on E5CN-C (Current Output Model).

2-3 Using the Support Software Port

Use the communications port for Support Software to connect the personal computer to the Temperature Controller when using EST2-2C-MV1 CX-Thermo or other Support Software. The E58-CIFQ1 USB-Serial Conversion Cable is required to make the connection.

For information concerning the models that can be used with CX-Thermo, contact your OMRON sales representative.

Procedure

Use the following procedure to connect the Temperature Controller to the personal computer using the USB-Serial Conversion Cable. The USB-Serial Conversion Cable is used to communicate with the COM port of the personal computer. To perform communications using USB-Serial Conversion Cable, set the communications port (COM port) number to be used for the software to the COM port assigned to the Cable.

1,2,3...

1. Turn ON the power to the Temperature Controller.

Note If the Cable is connected when the power to the Temperature Controller is OFF, power will be supplied from the personal computer and impose a load on the internal circuits of the Temperature Controller.

2. Connect the Cable.

Connect the personal computer's USB port with the Support Software port on the Temperature Controller using the Cable.

- Temperature Controller Connection Method

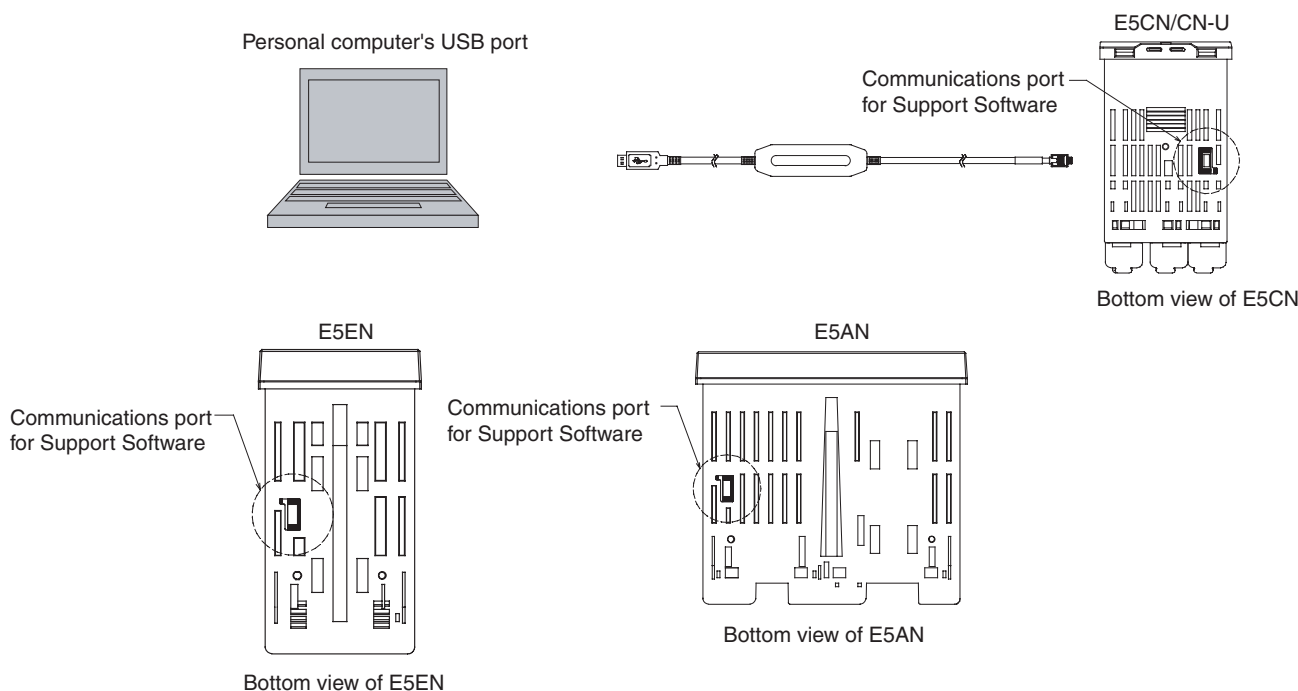

Note Hold the connector when inserting or disconnecting the Cable.

3. Install the driver.
Install the driver to enable the Cable to be used with the personal computer.
- Installation
When the Cable is connected with the personal computer, the OS detects the product as a new device. At this time, install the driver using the installation wizard. For details on installation methods, refer to the user's manual for the E58-CIFQ1 USB-Serial Conversion Cable.



SECTION 3

Basic Operation

This section describes the basic operation of the E5CN and E5CN-U Digital Temperature Controllers, including key operations to set parameters and descriptions of display elements based on specific control examples.

3-1	Initial Setting Examples	34
3-2	Setting the Input Type	36
3-2-1	Input Type	36
3-3	Selecting the Temperature Unit	38
3-3-1	Temperature Unit	38
3-4	Selecting PID Control or ON/OFF Control	38
3-5	Setting Output Specifications	38
3-5-1	Control Periods	38
3-5-2	Direct and Reverse Operation	39
3-5-3	Assigned Output Functions	40
3-6	Setting the Set Point (SP)	42
3-6-1	Changing the SP	42
3-7	Using ON/OFF Control	43
3-7-1	ON/OFF Control	43
3-7-2	Settings	44
3-8	Determining PID Constants (AT, ST, Manual Setup)	45
3-8-1	AT (Auto-tuning)	45
3-8-2	ST (Self-tuning)	46
3-8-3	RT (Robust Tuning)	48
3-8-4	Manual Setup	50
3-9	Alarm Outputs	51
3-9-1	Alarm Types	51
3-9-2	Alarm Values	53
3-10	Using HBA and HS Alarms	54
3-10-1	HBA and HS Alarm Operations	54
3-10-2	Installing Current Transformers (CT)	55
3-10-3	Calculating Detection Current Values	56
3-10-4	Application Examples	57
3-10-5	Settings (HBA)	61
3-10-6	Settings (HS Alarm)	62

3-1 Initial Setting Examples



Initial hardware setup, including the sensor input type, alarm types, control periods, and other settings is done using parameter displays. The  and  keys are used to switch between parameters, and the amount of time that you press the keys determines which parameter you move to.

This section describes two typical examples.

Explanation of Examples

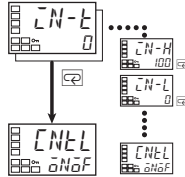
Changing Parameters



A  image means that there are parameters. Continue pressing the  key to change parameters until you reach the intended parameter.

Changing Numbers

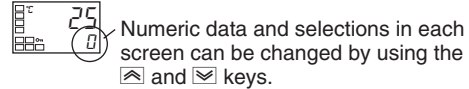

Example 1

Input type: 5 (K thermocouple, -200°C to 1,300°C)
 Control method: ON/OFF control
 Alarm type: 2 (upper limit)
 Alarm value 1: 20°C (deviation)
 Set point: 100°C

Setup Procedure

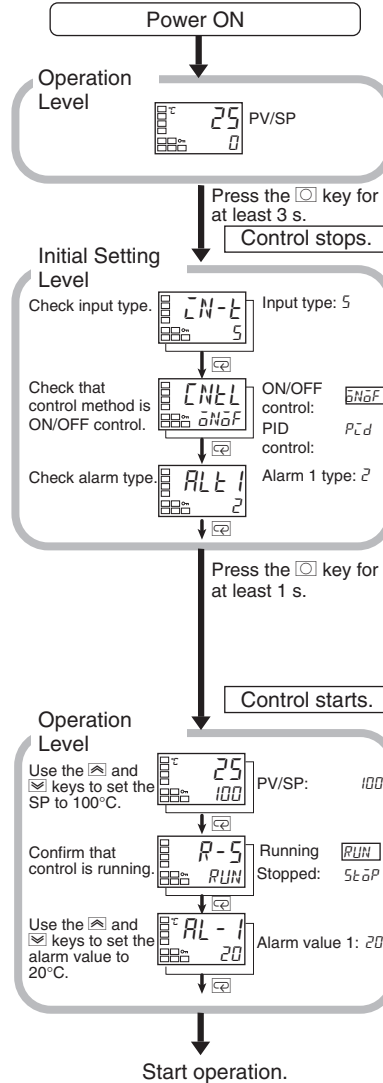
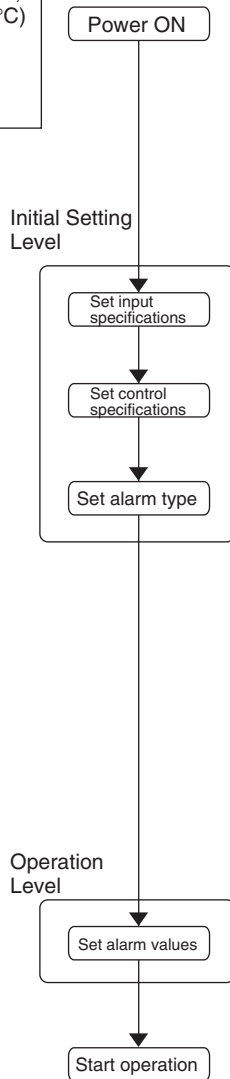

Example 2

Input type: 9 (T thermocouple, -200°C to 400°C)
 Control method: PID control
 PID constants found using auto-tuning (AT).
 Alarm type: 2 upper limit
 Alarm value 1: 30°C
 Set point: 150°C

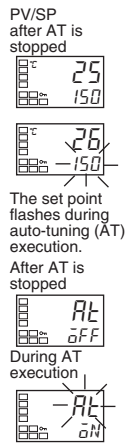
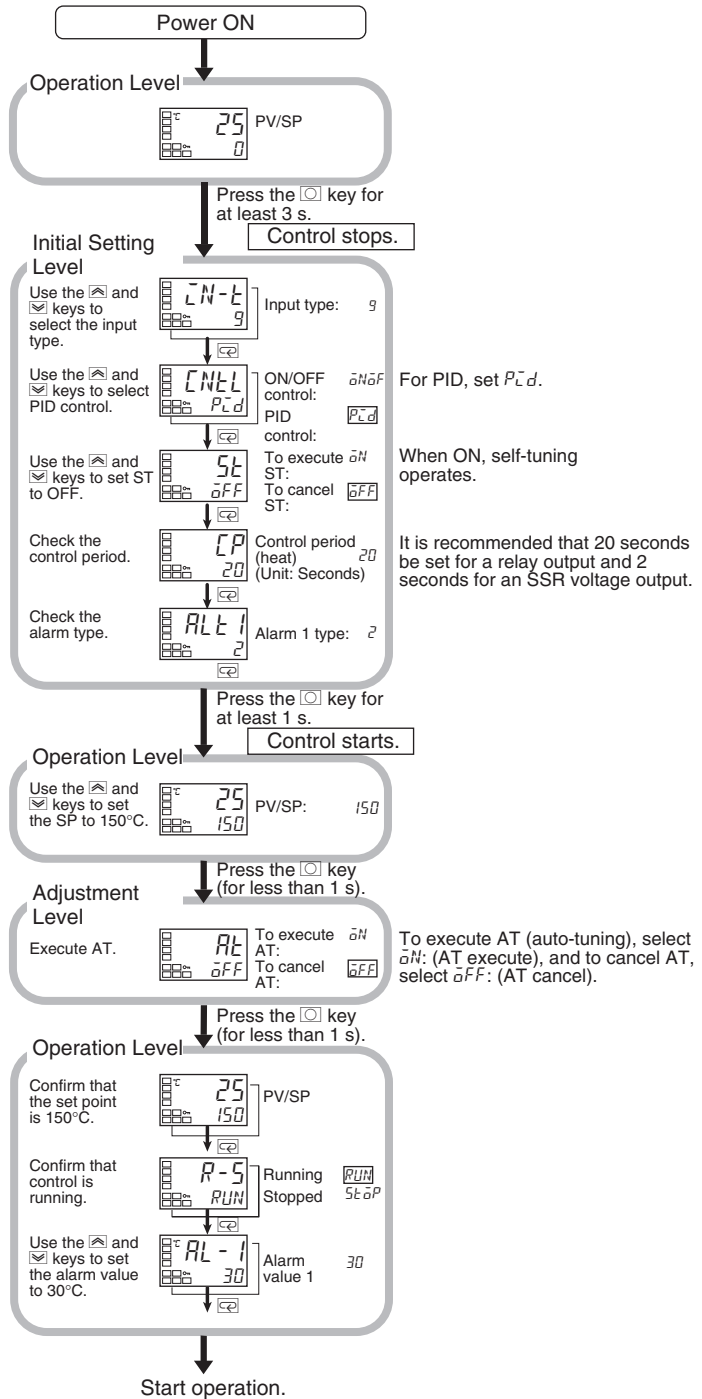
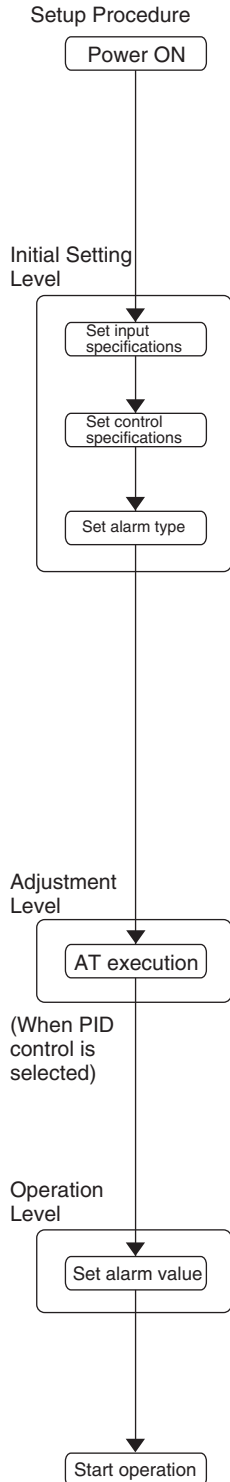

3-2 Setting the Input Type

The Controller supports four input types: platinum resistance thermometer, thermocouple, infrared temperature sensor, and analog inputs. Set the input type that matches the sensor that is used. In the product specifications, there are models with thermocouple/resistance thermometer inputs (multi-input) and models with analog input. The settings differ depending on the model. Check to make sure which model you are using.

3-2-1 Input Type

The following example shows how to set a K thermocouple for -20.0 to 500.0°C .



Operating Procedure

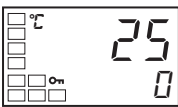

Operation Level

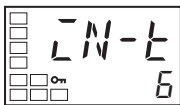
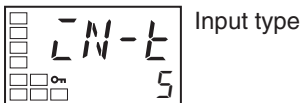

Initial Setting Level



1. Press the  key for at least three seconds to move from the operation level to the initial setting level.
2. Press the  key to enter the set value of the desired sensor. When you use a K thermocouple (-20.0 to 500.0°C), enter 6 as the set value.

Hint: The key operation is fixed two seconds after the change, or by pressing the  or  key.

List of Input Types

	Input type	Specifications	Set value	Input temperature setting range
Controllers with Thermocouple/Resistance Thermometer Multi-input	Platinum resistance thermometer	Pt100	0	-200 to 850 (°C)/-300 to 1,500 (°F)
			1	-199.9 to 500.0 (°C)/-199.9 to 900.0 (°F)
			2	0.0 to 100.0 (°C)/0.0 to 210.0 (°F)
		Thermocouple	JPt100	3
	4			0.0 to 100.0 (°C)/0.0 to 210.0 (°F)
	K		5	-200 to 1,300 (°C)/-300 to 2,300 (°F)
			6	-20.0 to 500.0 (°C)/0.0 to 900.0 (°F)
	J		7	-100 to 850 (°C)/-100 to 1,500 (°F)
			8	-20.0 to 400.0 (°C)/0.0 to 750.0 (°F)
	T		9	-200 to 400 (°C)/-300 to 700 (°F)
			10	-199.9 to 400.0 (°C)/-199.9 to 700.0 (°F)
	E		11	0 to 600 (°C)/0 to 1,100 (°F)
	L		12	-100 to 850 (°C)/-100 to 1,500 (°F)
	U		13	-200 to 400 (°C)/-300 to 700 (°F)
			14	-199.9 to 400.0 (°C)/-199.9 to 700.0 (°F)
	N		15	-200 to 1,300 (°C)/-300 to 2,300 (°F)
	R		16	0 to 1,700 (°C)/0 to 3,000 (°F)
	S	17	0 to 1,700 (°C)/0 to 3,000 (°F)	
	B	18	100 to 1,800 (°C)/300 to 3,200 (°F)	
	Infrared temperature sensor ES1B	10 to 70°C	19	0 to 90 (°C)/0 to 190 (°F)
		60 to 120°C	20	0 to 120 (°C)/0 to 240 (°F)
		115 to 165°C	21	0 to 165 (°C)/0 to 320 (°F)
140 to 260°C		22	0 to 260 (°C)/0 to 500 (°F)	
Analog input	0 to 50 mV	23	Either of the following ranges, by scaling: -1,999 to 9,999 -199.9 to 999.9	

- The default is 5.
- If a platinum resistance thermometer is mistakenly connected while a setting for other than a platinum resistance thermometer is in effect, S.ERR will be displayed. To clear the S.ERR display, check the wiring and then turn the power OFF and back ON.

	Input type	Specifications	Set value	Input temperature setting range
Models with analog input	Current input	4 to 20 mA	0	Either of the following ranges, by scaling: -1,999 to 9,999 -199.9 to 999.9 -19.99 to 99.99 -1.999 to 9.999
		0 to 20 mA	1	
	Voltage input	1 to 5 V	2	
		0 to 5 V	3	
		0 to 10 V	4	

- The default is 0.

3-3 Selecting the Temperature Unit

3-3-1 Temperature Unit

- Either °C or °F can be selected as the temperature unit.
- Set the temperature unit in the “temperature unit” parameter of the initial setting level. The default is \bar{C} (°C).

Operating Procedure

The following example shows how to select °C as the temperature unit.

Operation Level

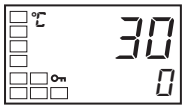

1. Press the \square key for at least three seconds to move from the operation level to the initial setting level.

Initial Setting Level

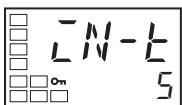

Input type

2. Select the “temperature unit” parameter by pressing the \square key. Press the \wedge or \vee key to select either °C or °F.
 \bar{C} : °C
 \bar{F} : °F

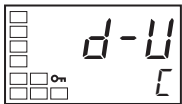

Temperature unit

3. To return to the operation level, press the \square key for at least one second.

3-4 Selecting PID Control or ON/OFF Control

Two control methods are supported: 2-PID control and ON/OFF control. Switching between 2-PID control and ON/OFF control is executed by means of the “PID ON/OFF” parameter in the initial setting level. When this parameter is set to $\bar{P}\bar{L}\bar{d}$, 2-PID control is selected, and when set to $\bar{a}\bar{N}\bar{o}\bar{F}$, ON/OFF control, is selected. The default is $\bar{a}\bar{N}\bar{o}\bar{F}$.

2-PID Control

PID control is set by AT (auto-tuning), ST (self-tuning), or manual setting.

For PID control, set the PID constants in the “proportional band” (P), “integral time” (I), and “derivative time” (D) parameters.

ON/OFF Control

In ON/OFF control, the control output is turned ON when the process value is lower than the current set point, and the control output is turned OFF when the process value is higher than the current set point (reverse operation).

3-5 Setting Output Specifications

3-5-1 Control Periods



- Set the output periods (control periods). Though a shorter period provides better control performance, it is recommended that the control period be set to 20 seconds or longer for a relay output to preserve the service life of the relay. After the settings have been made in the initial setup, readjust the control period, as required, by means such as trial operation.
- Set the control periods in the “control period (heat)” and “control period (cool)” parameters in the initial setting level. The default is 20 seconds.
- The “control period (cool)” parameter is used only for heating/cooling control.
- When control output 1 is used as a current output, “control period (heat)” cannot be used.

3-5-2 Direct and Reverse Operation



- “Direct operation” increases the manipulated variable whenever the process value increases. “Reverse operation” decreases the manipulated variable whenever the process value increases.

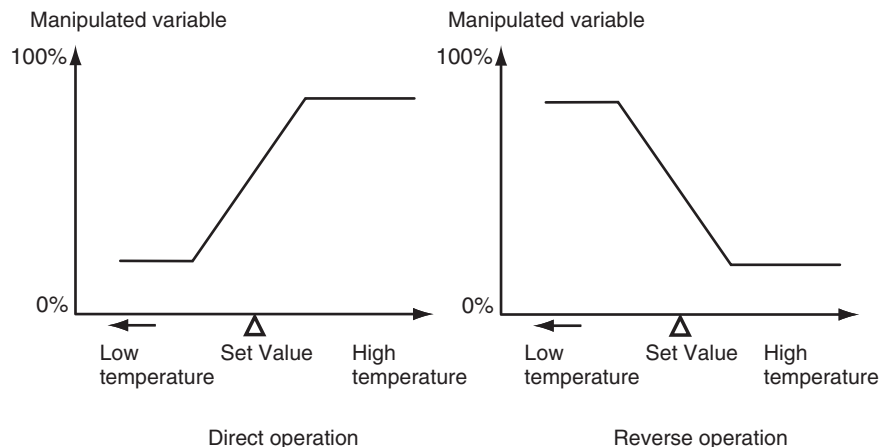

For example, when the process value (PV) is lower than the set point (SP) in a heating control system, the manipulated variable increases according to the difference between the PV and SP. Accordingly, reverse operation is used in a heating control system. Direct operation is used in a cooling control system, in which the operation is the opposite of a heating control system.

- Direct/reverse operation is set in the “direct/reverse operation” parameter in the initial setting level. The default is $\bar{D}R-R$ (reverse operation).

Operating Procedure

In this example, the input type, temperature unit, direct/reverse operation, and control period (heat) parameters are checked.

- Input type = 5 (K thermocouple)
- Temperature unit = C (°C)
- Direct/reverse operation = $\bar{D}R-R$ (reverse operation)
- Control period (heat) = 20 (seconds)

Operation Level

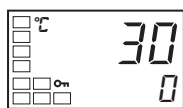

1. Press the key for at least three seconds to move from the operation level to the initial setting level.

Initial Setting Level

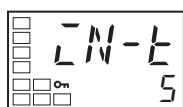

Input type

2. The input type is displayed. When the input type is being set for the first time, 5 (K thermocouple) is set. To select a different sensor, press the or key.

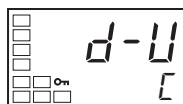

Temperature unit

3. Select the “temperature unit” parameter by pressing the key. The default is C (°C). To select F (°F), press the key.

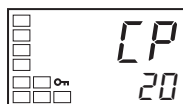

Control period (heat)

4. Select the “control period (heat)” parameter by pressing the key. The default is 20.



5. Select the “direct/reverse operation” parameter by pressing the key. The default is $\bar{a}R-R$ (reverse operation). To select $\bar{a}R-d$ (direct operation), press the key.

Operation Level



6. To return to the operation level, press the key for at least one second.

3-5-3 Assigned Output Functions

- Function assignments can be changed by changing the settings for control and alarm assignments.
- The default function assignments for each output are shown below.

Parameter name	Symbol	Initial status
Control output 1 assignment	$\bar{a}Ut 1$	Control output (heating)
Control output 2 assignment	$\bar{a}Ut 2$	Not assigned.
Alarm 1 assignment	$ALM 1$	Alarm 1
Alarm 2 assignment	$ALM 2$	Alarm 2
Alarm 3 assignment (E5AN/EN only)	$ALM 3$	Alarm 3

- Each output is automatically initialized as shown below by changing the control mode.

Example: E5CN

Parameter name	Symbol	With control output 2		Without control output 2	
		Standard	Heating/cooling	Standard	Heating/cooling
Control output 1 assignment	$\bar{a}Ut 1$	Control output (heating)	Control output (heating)	Control output (heating)	Control output (heating)
Control output 2 assignment	$\bar{a}Ut 2$	Not assigned. (See note 1.)	Not assigned. (See note 1.)	Not assigned.	Control output (cooling)
Alarm 1 assignment	$ALM 1$	Alarm 1 (See note 2.)	Alarm 1 (See note 2.)	Alarm 1 (See note 2.)	Alarm 1 (See note 2.)
Alarm 2 assignment	$ALM 2$	Alarm 2 (See note 3.)	Control output (cooling) (See note 3.)	Alarm 2	Alarm 2

- Note**
- (1) There is no control output 2 and no parameter assignment is displayed for that output.
 - (2) Alarm 1 becomes the program END output unless the program pattern is set to OFF.
 - (3) For the E5AN/EN, alarm 3 is assigned for control output (cooling) (alarm output 2 is assigned for alarm 2).

In this manual, assigned control outputs and alarm outputs are indicated as follows: “Control output 1 must be assigned” or “Alarm 1 must be assigned.”

Operating Procedure

The following example sets the following control and alarm assignments.
 Control output 1: Control output (heating); Control output 2: Control output (cooling); Alarm output 1: Alarm 1; Alarm output 2: Alarm 2

Operation Level



1. Press the key for at least three seconds to move from the operation level to the initial setting level.

Initial Setting Level

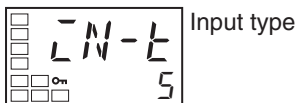

2. Select the “standard or heating/cooling” parameter by pressing the key.

Initial Setting Level



3. Press the key to set the parameter to H-E.

Note The following output assignments do not need to be set because they are set automatically by changing the control mode, but they are shown here as a reference for checking the assignments for each output.

Initial Setting Level

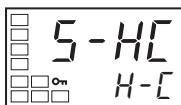

4. Select the “move to advanced function setting level” parameter by pressing the key.



Advanced Function Setting Level

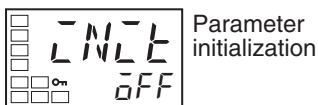

5. Press the key to enter the password (“-169”), and move from the initial setting level to the advanced function setting level.

Advanced Function Setting Level

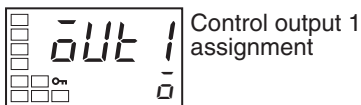

6. Select the “alarm 1 assignment” parameter by pressing the key.



7. Press the or key to set ā. (The default is ā.)

Advanced Function Setting Level



8. Select the “control output 2 assignment” parameter by pressing the key.

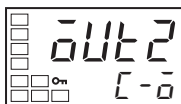

9. Press the or key to set C-ā. (When H-E is selected for the “standard or heating/cooling” parameter, the setting will be C-ā.)

Advanced Function Setting Level



Control output 1 assignment

10. Select the “alarm 1 assignment” parameter by pressing the key.



11. Press the or key to set *ALM1*.
(The default is *ALM1*.)

Advanced Function Setting Level



Control output 2 assignment

12. Select the “alarm 2 assignment” parameter by pressing the key.



13. Press the or key to set *ALM2*.
(The default is *ALM2*.)

Initial Setting Level

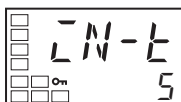

Input type

14. Press the key for at least one second to move from the advanced function setting level to the initial setting level.

Operation Level



PV/SP

15. Press the key for at least one second to move from the initial setting level to the operation level.

3-6 Setting the Set Point (SP)

Operation Level

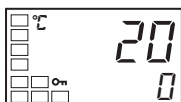

The operation level is displayed when the power is turned ON. The process value (PV) is at the top of the display, and the set point (SP) is at the bottom.

3-6-1 Changing the SP

- The set point cannot be changed when the “operation/adjustment protect” parameter is set to 3. For details, refer to 4-9 *Using the Key Protect Level*.
- To change the set point, press the or key in the “process value/set point” parameter (in the operation level), and set the desired set value. The new set point is selected two seconds after you have specified the new value.
- Multi-SP is used to switch between two or four set points. For details, refer to 4-5 *Using Event Inputs* for details.

Operating Procedure

In this example, the set point is changed from 0°C to 200°C.

Operation Level

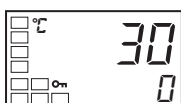

1. Normally, the “process value/set point” parameter is displayed. The set point is 0°C.

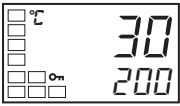

- Use the \boxtimes and \boxdot keys to set the set point to 200°C.

3-7 Using ON/OFF Control

In ON/OFF control, the control output turns OFF when the temperature being controlled reaches the preset set point. When the manipulated variable turns OFF, the temperature begins to fall and the control turns ON again. This operation is repeated over a certain temperature range. At this time, how much the temperature must fall before control turns ON again is determined by the “hysteresis (heating)” parameter. Also, what direction the manipulated variable must be adjusted in response to an increase or decrease in the process value is determined by the “direct/reverse operation” parameter.

3-7-1 ON/OFF Control

- Switching between 2-PID control and ON/OFF control is performed using the “PID ON/OFF” parameter in the initial setting level. When this parameter is set to $P\bar{L}d$, 2-PID control is selected, and when it is set to $\bar{a}N\bar{a}F$, ON/OFF control is selected. The default is $\bar{a}N\bar{a}F$.

Hysteresis

- With ON/OFF control, hysteresis is used to stabilize operation when switching between ON and OFF. The control output (heating) and control output (cooling) functions are set in the “hysteresis (heating)” and “hysteresis (cooling)” parameters, respectively.
- In standard control (heating or cooling control), the setting of the “hysteresis (heating)” parameter in the adjustment level is used as the hysteresis regardless of whether the control type is heating control or cooling control.

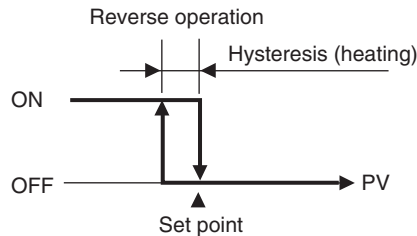

Three-position Control

- In heating/cooling control, a dead band (an area where both control outputs are 0) can be set to either the heating or cooling side. This makes it possible to use 3-position control.

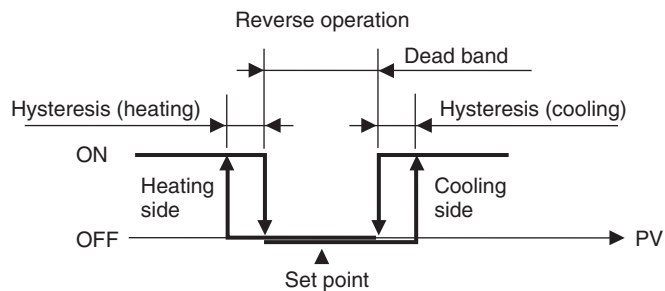

Parameters

Symbol	Parameter: Level	Application
S-HL	Standard or heating/cooling: Initial setting level	Specifying control method
CNEL	PID ON/OFF: Initial setting level	Specifying control method
āREV	Direct/reverse operation: Initial setting level	Specifying control method
L-db	Dead band: Adjustment level	Heating/cooling control
L-SC	Cooling coefficient: Adjustment level	Heating/cooling control
HYS	Hysteresis (heating): Adjustment level	ON/OFF control
CHYS	Hysteresis (cooling): Adjustment level	ON/OFF control

3-7-2 Settings

To execute ON/OFF control, set the “set point,” “PID ON/OFF,” and “hysteresis” parameters.

Setting the “PID ON/OFF” Parameter**Operating Procedure**

Confirm that the “PID ON/OFF” parameter is set to āNāF in the initial setting level.

Operation Level



1. Press the key for at least three seconds to move from the operation level to the initial setting level.

Initial Setting Level

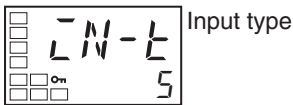

2. The “input type” parameter is displayed in the initial setting level.

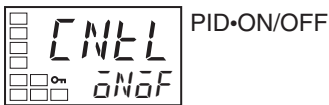

3. Select the “PID ON/OFF” parameter by pressing the key.

4. Check that the set value is āNāF (i.e., the default).

5. To return to the operation level, press the key for at least one second. Next, set the set point value.

Setting the SP**Operating Procedure**

In this example, the set point is set to 200. The set value (i.e., the SP) is shown at the bottom of the display.

Operation Level



1. Select the “process value/set point” parameter in the operation level.

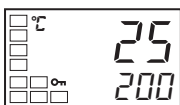

2. Use the and keys to set the SP. (In this example, it is set to 200.) The new set value can be fixed by pressing the key, or it will go into effect after two seconds have elapsed.

Next, set the hysteresis.

Setting the Hysteresis

Operating Procedure

Set the hysteresis to 2.0°C.

Operation Level

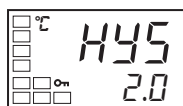
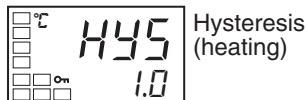
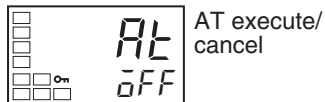
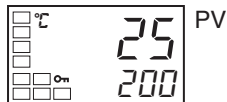

1. Press the key to move from the operation level to the adjustment level.
2. The “AT execute/cancel” parameter will be displayed in the adjustment level.
3. Select the “Hysteresis (heating)” parameter by pressing the key.
4. Press the and keys to set the hysteresis (2.0 in this example). Either press the key or wait for at least two seconds after setting the hysteresis value to confirm the setting.
5. To return to the operation level, press the key for at least one second.

3-8 Determining PID Constants (AT, ST, Manual Setup)

3-8-1 AT (Auto-tuning)



- When AT is executed, the optimum PID constants for the set point at that time are set automatically. A method (called the limit cycle method) for forcibly changing the manipulated variable and finding the characteristics of the control object is employed.
- To execute AT, specify *ON* (AT execute), and to cancel AT, specify *OFF* (AT cancel).
- AT cannot be executed when control has stopped or during ON/OFF control.
- The results of AT are reflected in the “proportional band” (P), “integral time” (I), and “derivative time” (D) parameters in the adjustment level.

Adjustment Level

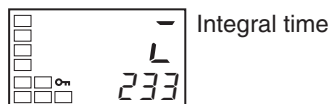

AT Operations

AT is started when the “AT execute/cancel” parameter is set to ON. During execution, the “AT execute/cancel” parameter on the No. 1 display flashes. When AT ends, the “AT execute/cancel” parameter turns OFF, and the No. 1 display stops flashing.

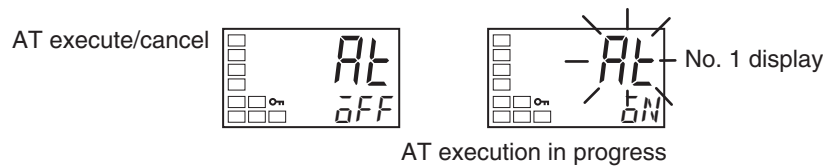

If you move to the operation level during AT execution, the No. 2 display flashes to indicate that AT is being executed.

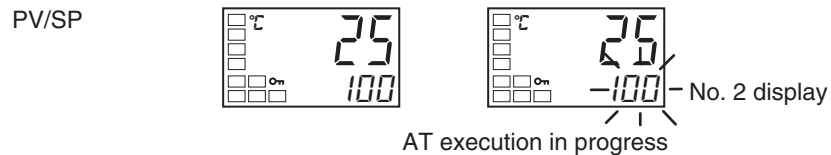

Only the “communications writing,” “RUN/STOP,” “AT execution/cancel,” and “program start” parameters can be changed during AT execution. Other parameters cannot be changed.

Operating Procedure

This procedure executes auto-tuning (AT).

Adjustment Level

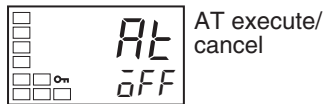

1. Press the key to move from the operation level to the adjustment level.
2. Press the key to start execution of AT (auto-tuning). $\bar{a}N$ will be displayed during AT execution.
3. $\bar{a}FF$ will be displayed when AT ends.
4. To return to the operation level, press the key.

Operation Level

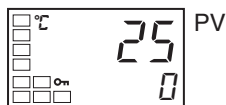

3-8-2 ST (Self-tuning)



ST (auto-tuning) is a function that finds PID constants by using step response tuning (SRT) when Controller operation begins or when the set point is changed.

Once the PID constants have been calculated, ST is not executed when the next control operation is started as long as the set point remains unchanged.

ST (self-tuning) is enabled when the “ST” parameter is set to ON in the initial setting level.

When the ST function is in operation, be sure to turn the power supply of the load connected to the control output ON simultaneously with or before starting Controller operation.

When executing self-tuning, turn ON power for the load (e.g., heater) at the same time as or before supplying power to the Digital Temperature Controller. If power is turned ON for the Digital Temperature Controller before turning ON power for the load, self-tuning will not be performed properly and optimum control will not be achieved.

Note PID Constants
 When control characteristics are already known, PID constants can be set directly to adjust control. PID constants are set in the “proportional band” (P), “integral time” (I), and “derivative time” (D) parameters in the adjustment level.

Operating Procedure

This procedure executes self-tuning (ST).

Initial Setting Level

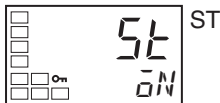
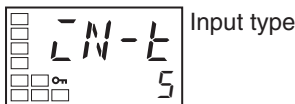

1. Press the key for at least three seconds to move from the operation level to the initial setting level.
2. Select the “ST” parameter by pressing the key.
3. Press the key to select $\bar{a}N$. ON is the default.
4. To return to the operation level, press the key. The temperature display flashes during self-tuning (ST) execution.

Startup Conditions

Self-tuning by step response tuning (SRT) is started when the following conditions are met after program execution is started and the set point is changed.

At start of operation	When set point is changed
<ol style="list-style-type: none"> 1. The set point at the start of operation differs from the set point when the previous SRT was executed. (See note 1.) 2. The difference between the temperature at the start of operation and the set point is greater both of the following: (Present proportional band \times 1.27 + 4°C) and the ST stable range. 3. The temperature at the start of operation is lower than the set point during reverse operation, and is larger than the set point during direct operation. 4. There is no reset from input errors. 	<ol style="list-style-type: none"> 1. The new set point differs from the set point used when the previous SRT was executed. (See note 1.) 2. The set point change width is greater both of the following: (Present proportional band \times 1.27 + 4°C) and the ST stable range. 3. During reverse operation, the new set point is larger than the set point before the change; and during direct operation, the new set point is smaller than the set point before the change. 4. The temperature is stable. (See note 2.) (Equilibrium with the output amount at 0% when the power is turned ON is also all right.) (See note 3.)

- Note**
- (1) The previous SRT-implemented set point is the set point that was used for calculating the PID constants for the previous SRT.
 - (2) In this state, the measurement point is within the ST stable range.
 - (3) In this state, the change width of the PV every 60 seconds is within the ST stable range or less.

In the following instances, PID constants are not changed by self-tuning (ST) for the present set point.

- 1,2,3...**
1. When the PID constants have been changed manually with ST set to ON.
 2. When auto-tuning (AT) has been executed.

ST Stable Range

Operating Procedure

The ST stable range determines the condition under which ST (self-tuning) functions.

This procedure sets the ST stable range to 20°C.

Advanced Function Setting Level

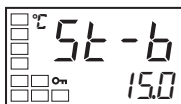

ST stable range

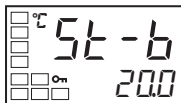

1. Select the “ST stable range” parameter by pressing the key in the advanced function setting level.
2. Use the key to set the parameter to 20°C.

3-8-3 RT (Robust Tuning)



- When AT or ST is executed with RT selected, PID constants are automatically set that make it hard for control performance to degenerate even when control object characteristics are changed.
- RT can be set in the advanced function setting level when PID control has been set.
- The RT mode cannot be selected while an analog input is set.
- Selecting the RT mode in the following cases will help to prevent hunting from occurring.
 - When the set temperature is not fixed and is changed in a wide range
 - When there are large variations in ambient temperatures due to factors such as seasonal changes or differences between day and night temperatures
 - When there are large variations in ambient wind conditions and air flow
 - When heater characteristics change depending on the temperature
 - When an actuator with disproportional I/O, such as a phase-control-type power regulator, is used
 - When a rapidly heating heater is used
 - When the control object or sensor has much loss time
 - When hunting occurs in normal mode for any reason
- PID constants are initialized to the factory settings by switching to RT mode.
- When the RT mode is selected, the derivative time setting unit becomes the second.

RT Features

- Even when hunting occurs for PID constants when AT or ST is executed in normal mode, it is less likely to occur when AT or ST is executed in RT mode.

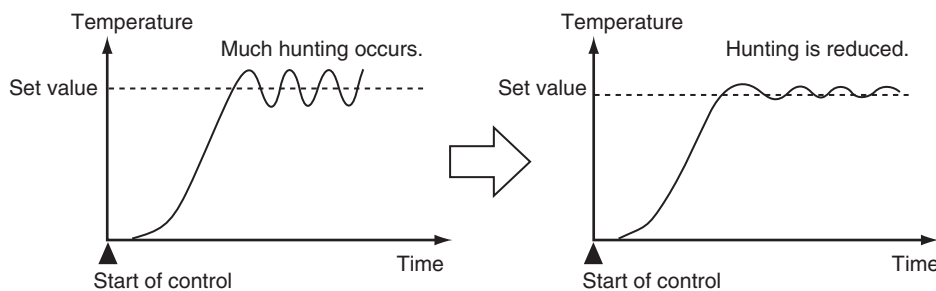

- When the temperature (PV) falls short of the set point for the PID constants when using AT or ST in normal mode, executing AT or ST in RT mode tends to improve performance.

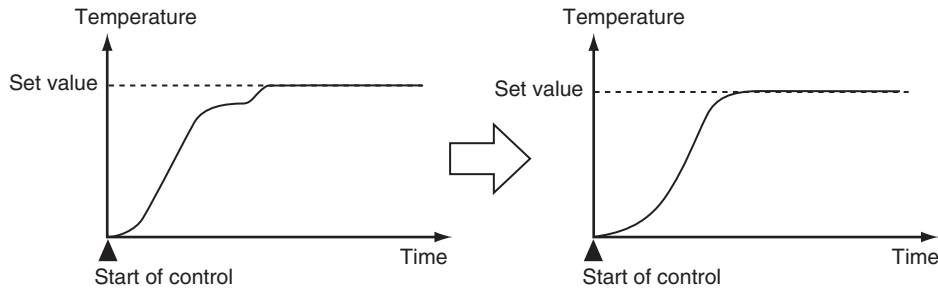

- When the manipulated variable (MV) is saturated, the amount of overshooting may be somewhat higher in comparison to PID control based on AT or ST in normal mode.

Operating Procedure

This procedure selects RT mode.

Operation Level



1. Press the key for at least three seconds to move from the operation level to the initial setting level.

Initial Setting Level

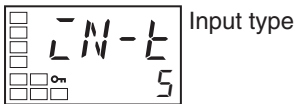

2. Select the “move to advanced function setting level” parameter by pressing the key.

Initial Setting Level



3. Use the key to enter “-169” (the password).

Advanced Function Setting Level

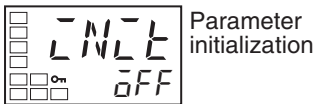

It is possible to move to the advanced function setting level by pressing the key or leaving the setting for at least two seconds.

Advanced Function Setting Level

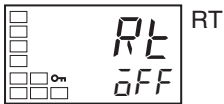

4. Press the key to select *RT*.

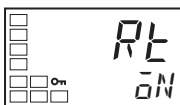

5. Press the key to select *ON*. *OFF* is the default.

Operation Level



6. To return to the initial setting level, press the key for at least one second.
7. To return to the operation level, press the key for at least one second.

3-8-4 Manual Setup

Individual PID constants can be manually set in the “proportional band,” “integral time,” and “derivative time” parameters in the adjustment level.

Operating Procedure

In this example, the “proportional band” parameter is set to 10.0, the “integral time” parameter to 250, and the “derivative time” parameter to 45.

Adjustment Level

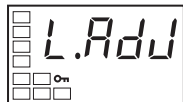

Adjustment level display

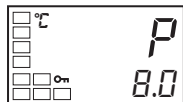

Proportional band

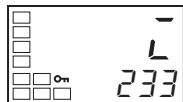
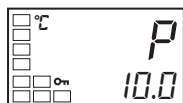

Integral time

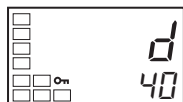
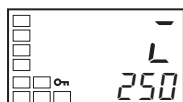

Derivative time

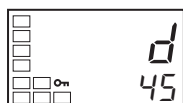

1. Press the key to move from the operation level to the adjustment level.
2. Press the key to select the “proportional band” parameter.
3. Use the and keys to set 10.0.
4. Press the key to select the “integral time” parameter.
5. Use the and keys to set 250.
6. Select the “derivative time” operation by pressing the key.
7. Use the and keys to set 45.
8. To return to the operation level, press the key.

Note Proportional Action

When PID constants I (integral time) and D (derivative time) are set to 0, control is executed according to proportional action. As the default, the center value of the proportional band becomes the set point.
 Related parameter: Manual reset value (adjustment level)

When P (Proportional Band) Is Adjusted

Increased		The curve rises gradually, and a long stabilization time is created, but overshooting is prevented.
Decreased		Overshooting and hunting occur, but the set value is quickly reached and the temperature stabilizes.

When I (Integral Time) Is Adjusted

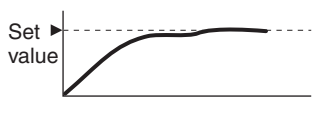
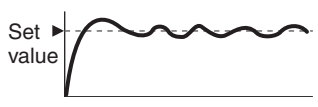
Increased		It takes a long time to reach the set point. It takes time to achieve a stable state, but overshooting, undershooting, and hunting are reduced.
Decreased		Overshooting and undershooting occur. Hunting occurs. The Controller starts up faster.

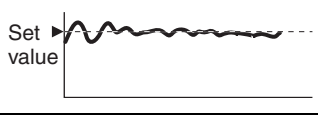
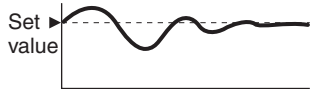

When D (Derivative Time) Is Adjusted

Increased		Overshooting, undershooting, and stabilization times are reduced, but fine hunting occurs on changes in the curve itself.
Decreased		Overshooting and undershooting increase, and it takes time to return to the set point.

3-9 Alarm Outputs

- Alarms can be used by the E5CN-□2□□□ (2 alarm points), E5AN/EN-□1□□□ (1 alarm point), E5AN/EN-□3□□□ (3 alarm points), the E5CN-□1□□□U (1 alarm point), or the E5CN-□2□□□U (2 alarm points). Alarm outputs are determined by a combination of “alarm type,” “alarm value,” and “alarm hysteresis” alarm output conditions. For details, refer to *4-2 Alarm Hysteresis*.
- This section describes the “alarm type,” “alarm value,” “upper-limit alarm” and “lower-limit alarm” parameters.

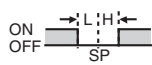
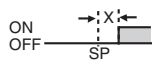
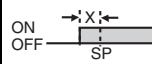
3-9-1 Alarm Types

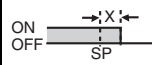
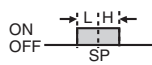
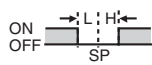
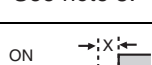
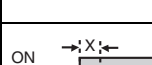
Set value	Alarm type	Alarm output operation	
		When alarm value X is positive	When alarm value X is negative
0	Alarm function OFF	Output OFF	
1	Upper- and lower-limit		See note 2.
2 (See note 1.)	Upper-limit		
3	Lower-limit		
4 (See note 1.)	Upper- and lower-limit range		See note 3.
5 (See note 1.)	Upper- and lower-limit with standby sequence	 See note 5.	See note 4.
6	Upper-limit with standby sequence		

Set value	Alarm type	Alarm output operation	
		When alarm value X is positive	When alarm value X is negative
7	Lower-limit with standby sequence		
8	Absolute-value upper-limit		
9	Absolute-value lower-limit		
10	Absolute-value upper-limit with standby sequence		
11	Absolute-value lower-limit with standby sequence		
12	LBA (alarm 1 type only)	---	

Note

- (1) With set values 1, 4, and 5, the upper- and lower-limit values can be set independently for each alarm type, and are expressed as “L” and “H.”
- (2) Set value: 1 (Upper- and lower-limit alarm)

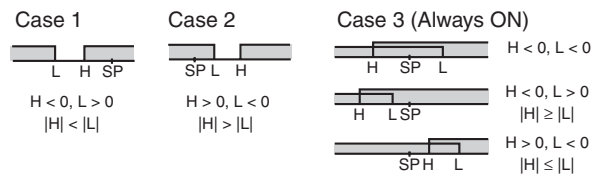

- (3) Set value: 4 (Lower limit range)

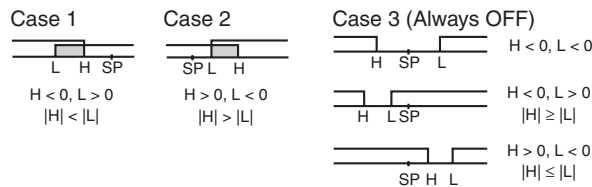

- (4) Set value: 5 (Upper- and lower-limit with standby sequence)
 - For the lower-limit alarms in cases 1 and 2 above, the alarm is always OFF if upper- and lower-limit hysteresis overlaps.
 - In case 3, the alarm is always OFF.
- (5) Set value: 5 (Upper- and lower-limit with standby sequence)
 - The alarm is always OFF if upper- and lower-limit hysteresis overlaps.
 - Set the alarm type independently for each alarm in the “alarm 1 to 3 type” parameters in the initial setting level. The default is 2 (Upper-limit alarm).

3-9-2 Alarm Values

 Alarm lower limit value





 Alarm upper limit value





 Alarm value



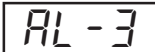

- Alarm values are indicated by “X” in the table on the previous page. When the upper and lower limits are set independently, “H” is displayed for upper limit values, and “L” is displayed for lower limit values.
- To set the alarm value upper and lower limits for deviation, set the upper and lower limits in each of the “alarm 1 to 3 upper limit,” and “alarm 1 to 3 lower limit” parameters in the operation level.

Operating Procedure

This procedure sets alarm 1 as an upper-limit alarm. The related parameters and settings are shown below. The alarm is output when the set point exceeds 10°C. (In this example, the temperature unit is °C.)

Alarm 1 type = 2 (Upper-limit alarm)

Alarm value 1= 10

Initial Setting Level

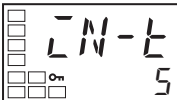

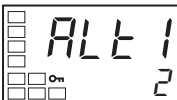

 Input type

 Alarm 1 type

 PV/SP

 Alarm value 1



1. Press the  key for at least three seconds to move from the operation level to the initial setting level.
2. Select the “alarm 1 type” parameter by pressing the  key. Confirm that the set value is 2. The default value is 2 (Upper-limit alarm).
3. To return to the operation level, press the  key for at least one second.
4. Select the “alarm value 1” parameter by pressing the  key.
5. Use the  key to set the parameter to 10.

3-10 Using HBA and HS Alarms

3-10-1 HBA and HS Alarm Operations

- Heater burnout detection is executed by measuring heater current while the control output for heating is ON, and HS detection is executed by measuring heater current while it is OFF. For details, refer to the following table.
(Heater burnout detection and HS detection cannot be used with the control output for cooling.)

Heating control output status		Power to heater	HBA output	HS alarm output
Control output (heating)	Operation indicator			
ON	Lit	Yes (Normal) (See note 1.)	OFF	---
		No (Heater burnout)	ON	---
OFF	Not lit	Yes (HS alarm)	---	ON
		No (Normal) (See note 2.)	---	OFF

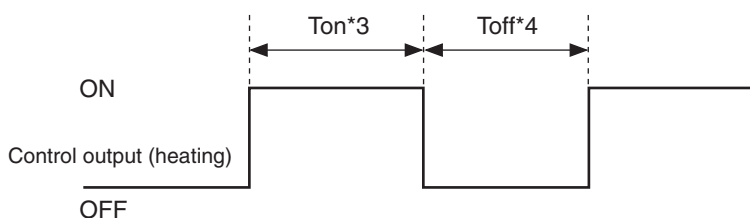

- Note**
- (1) In the above diagram, power is considered to be ON (normal) if the heater current is greater than the heater burnout detection current during the Ton interval. If the heater is burned out, the measured current decreases and falls below the heater burnout detection value. The output is then activated as the heater burnout alarm.
 - (2) In the above diagram, power is considered to be OFF (normal) if the leakage current is less than the HS alarm current during the Toff interval. If the SSR output is short-circuited, the measured current increases beyond the HS alarm value. The output is then activated as the HS alarm.
 - (3) Heater burnouts are not detected if the control output (heating) ON time (Ton) is 190 ms or less.
 - (4) HS are not detected if the control output (heating) OFF time (Toff) is 190 ms or less.
- For models with HBA and HS alarms, an OR output is established between the ALM 1 function and the HBA/HS alarm. If the ALM1 function is to be used for HBA and HS alarms only, set 0 as the ALM1 type and do not use ALM1.
 - Turn the heater power ON simultaneously or before turning ON the E5□N power. If the heater power is turned ON after turning ON the E5AN power, the HBA will be activated.
 - Control is continued even when the HBA or HS alarm is active.
 - The rated current value may sometimes differ slightly from the actual current flowing to the heater.
Use the “heater current 1 value monitor,” “heater current 2 value monitor,” “leakage current 1 monitor,” and “leakage current 2 monitor” parameters to check the actual current being used.

- If there is little difference between the current in normal and abnormal states, detection may become unstable. To stabilize detection, set a current value difference of at least 1.0 A for heaters of less than 10.0 A, and at least 2.5 A for heaters of 10.0 A or more. If the heater current is too low, loop the load line several times through a CT, as shown in the diagram below. Looping it through twice will double the detection current.

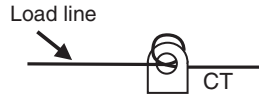

3-10-2 Installing Current Transformers (CT)

- This function can be used with E5□N models that have the HBA and HS alarm.
 For the E5CN, connect the CT in advance to terminals 14 and 15 (CT1), or 13 and 15 (CT2). For the E5AN/EN, connect the CT in advance to terminals 14 and 15 (CT1) or 15 and 19 (CT2). Then pass the heater power line through the CT's hole.
 For specifications, models and dimensions of current transformers that can be used with this Controller, see *Appendix A Current Transformer (CT)* page 201.

Single-phase Heaters

For single-phase heaters, install the CT in the position shown in the following diagram.

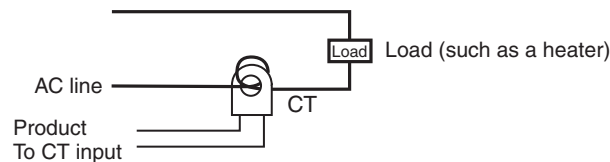

Three-phase Heaters (E5□N-□□HH□ 3-phase Heater Detection Models)

When a 3-phase power supply is used, regardless of the types of connecting lines, two current transformers (CTs) are required to detect heater burnout and HS.

1,2,3...

1. Delta connecting lines: Refer to the following diagram for CT installation positions.

Note Heater voltage fluctuations are not considered here, so be take that into account when setting the detection current.

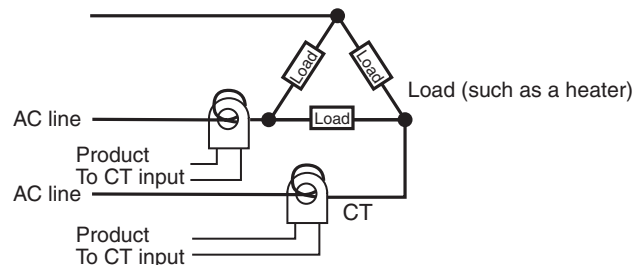

2. Star connecting lines: Refer to the following diagram for CT installation positions.

Note Heater voltage fluctuations are not considered here, so be take that into account when setting the detection current.

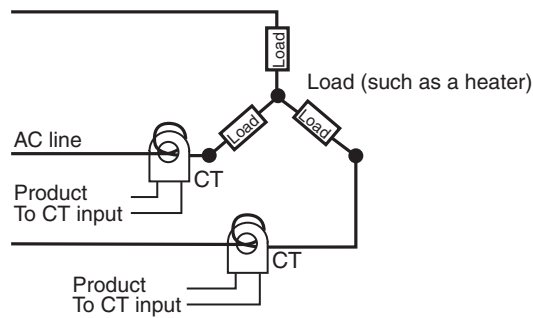

3. V connecting lines: Refer to the following diagram for CT installation positions.

Note Heater voltage fluctuations are not considered here, so be take that into account when setting the detection current.

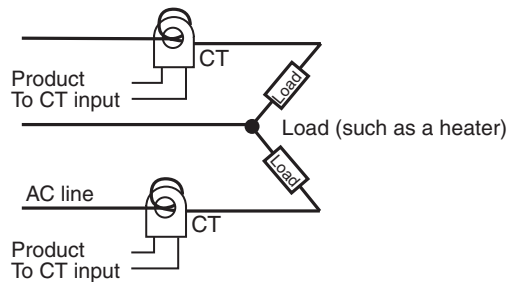

3-10-3 Calculating Detection Current Values

- Calculate the set value using the following equation:

$$\text{Heater Burnout Detection 1/2 set value} = \frac{\text{Normal current value} + \text{Burnout current value}}{2}$$

$$\text{HS Alarm 1/2 set value} = \frac{\text{Leakage current value (output OFF)} + \text{HS current value}}{2}$$

- To set the current for heater burnout when two or more heaters are connected through the CT, use the value from when the heater with the smallest current burns out. If all of the heaters have the same current, use the value from when any one of them burns out.
- Make sure that the following conditions are satisfied:
 Heater with a current of less than 10.0 A:
 $(\text{Current value at normal operation}) - (\text{Current value at heater burnout}) \geq 1 \text{ A}$
 When the difference is less than 1 A, detection is unstable.
 Heater with a current of 10.0 A or more:
 $(\text{Current value at normal operation}) - (\text{Current value at heater burnout}) \geq 2.5 \text{ A}$
 When the difference is less than 2.5 A, detection is unstable.
- The setting range is 0.1 to 49.9 A. Heater burnout and HS are not detected when the set value is 0.0 or 50.0.
 When the set value is 0.0, the heater burnout alarm is always OFF, and the HS alarm is always ON.
 When the set value is 50.0, the heater burnout alarm is always ON, and the HS alarm is always OFF.

- Set the total current value for normal heater operation to 50 A or less. When a current value of 55.0 A is exceeded, FFFF is displayed in the “heater current 1 (and 2) value monitor” and “leakage current 1 (and 2) monitor” parameters.

3-10-4 Application Examples

Single-phase Heaters

Example: Using a 200-VAC, 1-kW Heater

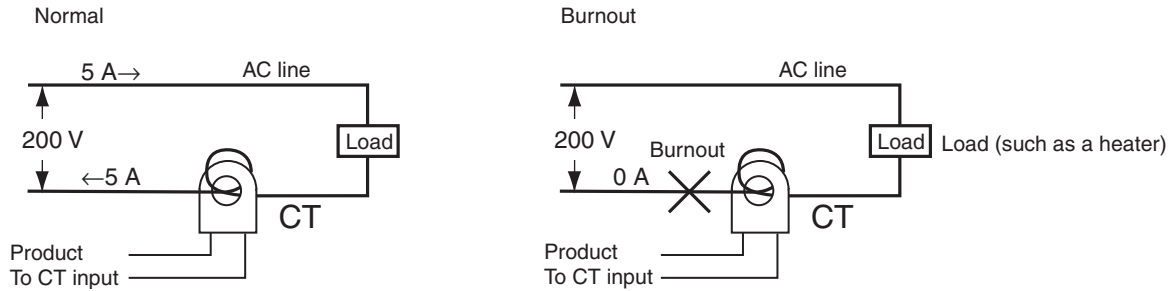

The heater power supply provides 5 A when the current is normal, and 0 A when there is a burnout, so the heater burnout detection current is calculated as follows:

$$\begin{aligned} \text{Heater burnout detection current} &= \frac{(\text{Normal current}) + (\text{Heater burnout current})}{2} \\ &= \frac{5 + 0}{2} = 2.5 \text{ [A]} \end{aligned}$$

Example: Using Three 200-VAC, 1-kW Heaters

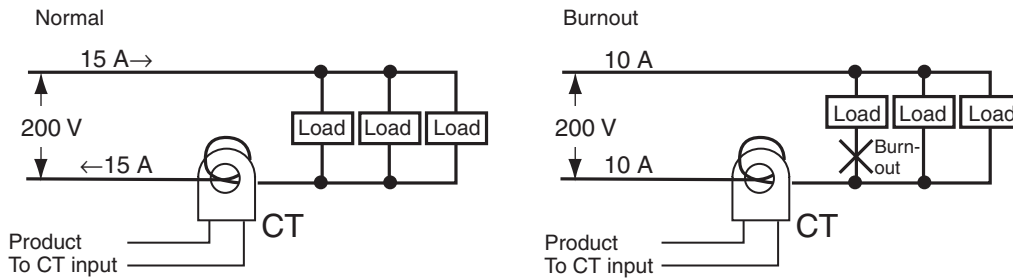

The heater power supply provides 15 A when the current is normal, and 10 A when there is a burnout, so the heater burnout detection current is calculated as follows:

$$\begin{aligned} \text{Heater burnout detection current} &= \frac{(\text{Normal current}) + (\text{Heater burnout current})}{2} \\ &= \frac{15 + 10}{2} = 12.5 \text{ [A]} \end{aligned}$$

Three-phase Heaters

Delta Connecting Lines

Example: Using Three 200-VAC, 2-kW Heaters

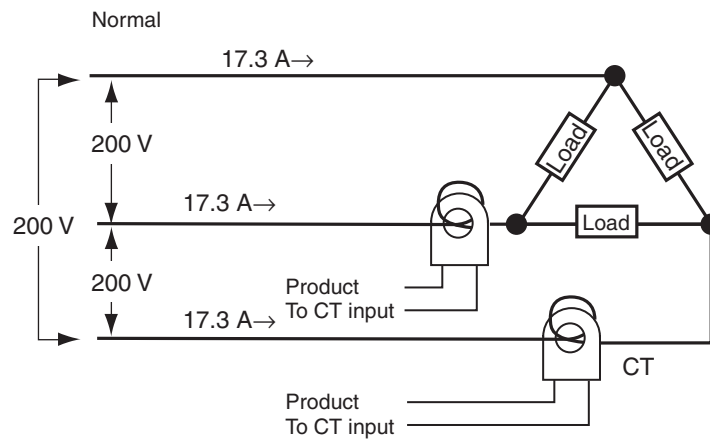

The current when each phase is normal is 17.3 A ($\approx \sqrt{3} \times 10$ A).

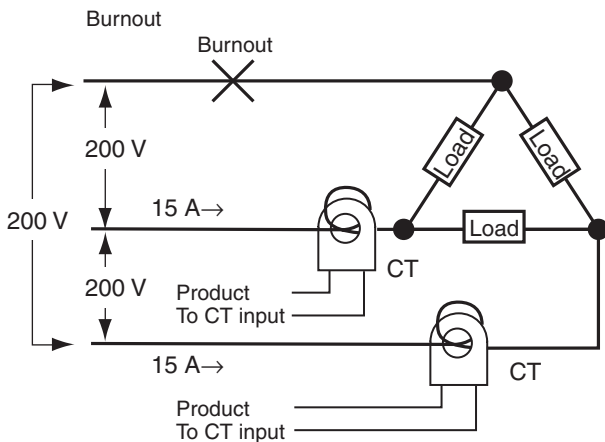

Current when there is a burnout = $10 \text{ A} \times \sqrt{3} \times (\sqrt{3}/2) = 15 \text{ A}$

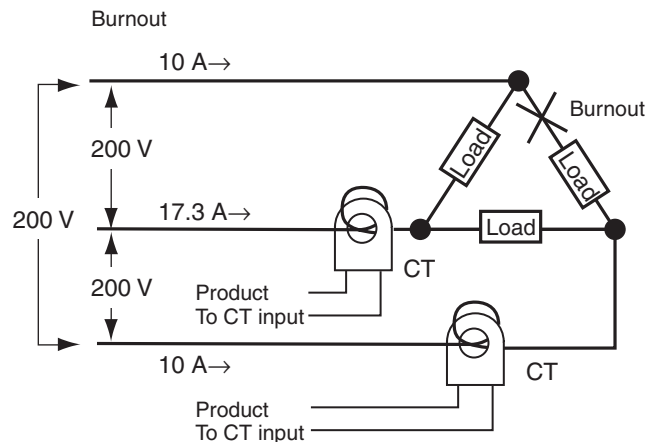

Current when there is a burnout = $10 \text{ A} \times \sqrt{3} \times (1/\sqrt{3}) = 10 \text{ A}$

The heater burnout current when there is a burnout at the load line is as follows:

$$(\text{Heater burnout detection current}) = (17.3 + 15) / 2 \approx 16.1 \text{ [A]}$$

The heater burnout current when there is a burnout at the load is as follows:

$$(\text{Heater burnout detection current}) = (17.3 + 10) / 2 \approx 13.65 \text{ [A]}$$

To enable detection in either case, use 16.1 A as the heater burnout detection current.

Star Connecting Lines

Example: Using Three 200-VAC, 2-kW Heaters

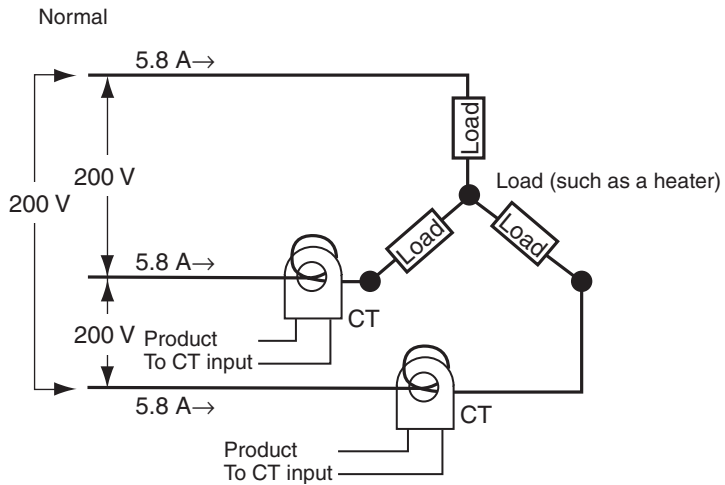

The current when each phase is normal is 5.8 A ($\approx 10 \text{ A} \times (1/\sqrt{3})$).

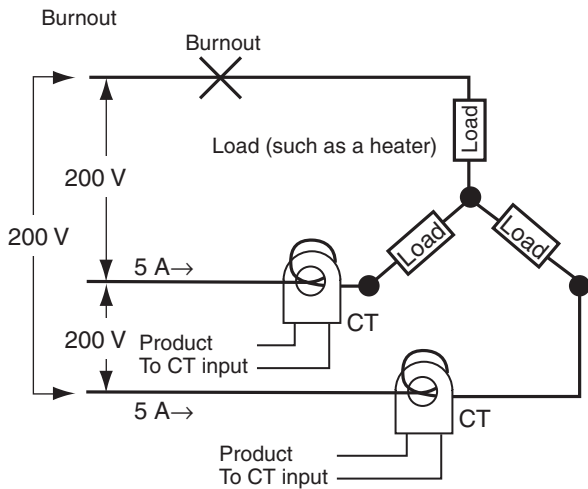

$$\text{Current when there is a burnout} = 10 \text{ A} \times (1/\sqrt{3}) \times (\sqrt{3}/2) = 5 \text{ A}$$

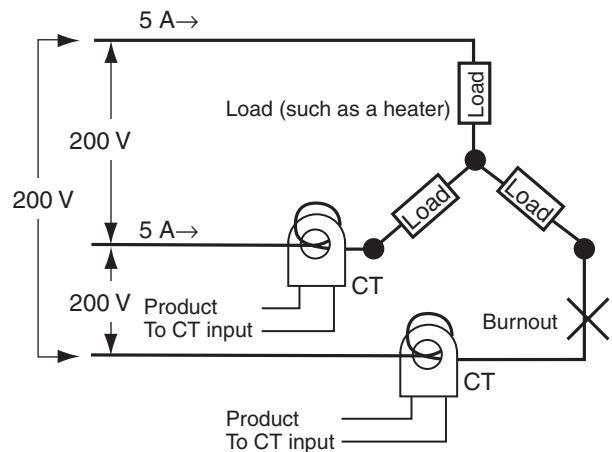

$$\text{Current when there is a burnout} = 10 \text{ A} \times (1/\sqrt{3}) \times (\sqrt{3}/2) = 5 \text{ A}$$

The heater burnout detection current for this connecting line is 5.4 A (= (5.8 + 5) / 2).

V Connecting Lines

Example: Using Two 200-VAC, 2-kW Heaters

Normal

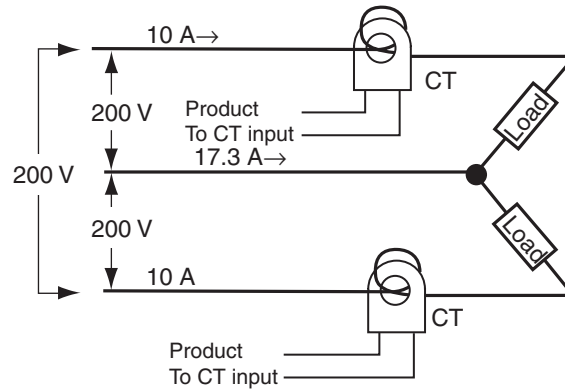

Burnout

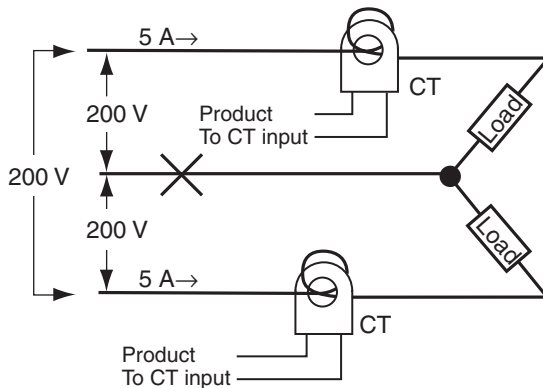

Current when there is a burnout = $10 \text{ A} \times (1/2)$
= 5 A

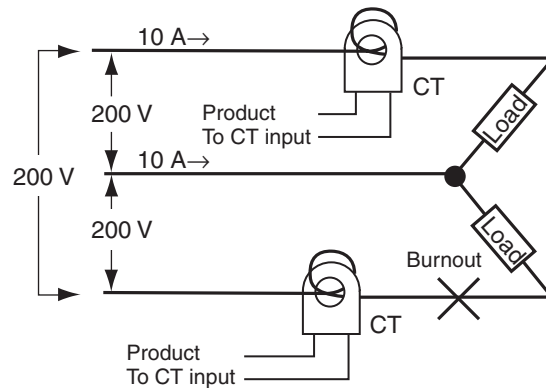

Current when there is a burnout = 0 A

The heater burnout current when there is a burnout at the common is as follows:

$$\text{Heater burnout detection current} = (10 + 5) / 2 \approx 7.5 \text{ [A]}$$

The heater burnout current when there is a burnout at the load is as follows:

$$\text{Heater burnout detection current} = (10 + 0) / 2 \approx 5 \text{ [A]}$$

To enable detection in either case, use 7.5 A as the heater burnout detection current.

3-10-5 Settings (HBA)

To activate the heater burnout alarm, set the “heater burnout detection” parameter to ON in the advanced function setting level and set the “heater burnout detection 1” and “heater burnout detection 2” parameters in the adjustment level.

Operating Procedure

This procedure sets the “heater burnout detection 1” parameter to 2.5.

■ Moving to the Advanced Function Setting Level

The “heater burnout detection” parameter setting is already ON by default, so set the “heater burnout detection 1” parameter.

Operation Level



1. Move to the advanced function setting level.
Press the key for at least three seconds to move from the operation level to the initial setting level.

Initial Setting Level

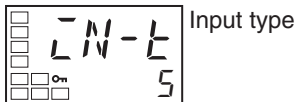

2. Select “move to advanced function setting level” by pressing the key.

Initial Setting Level



3. Press the key to enter the password (-169), and move from the initial setting level to the advanced function setting level.

Advanced Function Setting Level

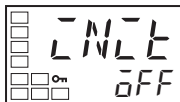

The top parameter in the advanced function setting level is displayed.

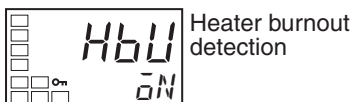

4. Select the “heater burnout detection” parameter by pressing the key. Check that this parameter is set to ON (the default). Next, set the “heater current 1 value monitor” parameter.

■ Setting Heater Burnout Detection

Operation Level



5. Press the key for at least one second to move from the advanced function setting level to the initial setting level and then to the operation level.

Adjustment Level



6. Press the key for less than one second to move from the operation level to the adjustment level.

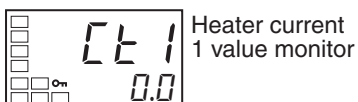

7. Select the “heater current 1 value monitor” parameter by pressing the key. Check the current value. Next, set the “heater burnout detection 1” parameter.

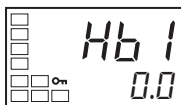

Heater burnout detection 1



8. Select the “heater burnout detection 1” parameter by pressing the key. Refer to 3-10-3 Calculating Detection Current Values on page 56 when making the settings.

9. For this example, set 2.5. To return to the operation level, press the key for less than one second.

3-10-6 Settings (HS Alarm)

To activate the HS alarm, set the “HS alarm use” parameter to ON in the advanced function setting level and set the “HS alarm 1” and “HS alarm 2” parameters in the adjustment level.

Operating Procedure

This procedure sets the “HS alarm 1” parameter to 2.5.

■ Moving to the Advanced Function Setting Level

The “HS alarm use” parameter setting is already ON by default, so set the “HS alarm 1” parameter.

Operation Level



PV/SP

1. Move to the advanced function setting level. Press the key for at least three seconds to move from the operation level to the initial setting level.

Initial Setting Level

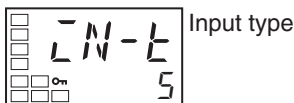

Input type

2. Select “move to advanced function setting level” by pressing the key.

Initial Setting Level



Moves to advanced function setting level

3. Press the key to enter the password (-169), and move from the initial setting level to the advanced function setting level.

Advanced Function Setting Level

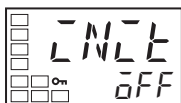

The top parameter in the advanced function setting level is displayed.

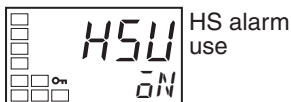

HS alarm use

4. Select the “HS alarm use” parameter by pressing the key. Check that this parameter is set to ON (the default). Next, set the “leakage current 1 monitor” parameter.

■ HS Alarm Settings

Operation Level



Adjustment Level

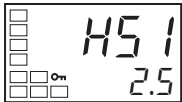
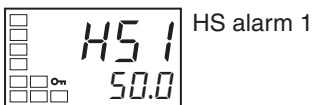
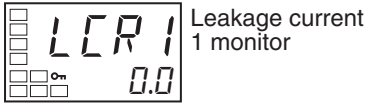

5. Press the key for at least one second to move from the advanced function setting level to the initial setting level and then to the operation level.
6. Press the key for less than one second to move from the operation level to the adjustment level.
7. Select the "leakage current 1 monitor" parameter by pressing the key. Check the current value. Next, set the "HS alarm 1" parameter.
8. Select the "HS alarm 1" parameter by pressing the key. Refer to *3-10-3 Calculating Detection Current Values* on page 56 when setting the values.
9. For this example, set 2.5. To return to the operation level, press the key for less than one second.

SECTION 4

Applications Operations

This section describes scaling, the SP ramp function, and other special functions that can be used to make the most of the functionality of the E5CN and E5CN-U Digital Temperature Controllers.

4-1	Shifting Input Values	67
4-1-1	Shifting Inputs	67
4-1-2	How to Calculate Input Shift Values for a 2-point Shift.	68
4-2	Alarm Hysteresis.	71
4-2-1	Standby Sequence.	71
4-2-2	Alarm Latch	71
4-2-3	Close in Alarm/Open in Alarm.	72
4-3	Setting Scaling Upper and Lower Limits for Analog Inputs	73
4-3-1	Analog Input.	73
4-4	Executing Heating/Cooling Control	74
4-4-1	Heating/Cooling Control	74
4-4-2	Settings	76
4-5	Using Event Inputs	77
4-5-1	Event Input Settings	77
4-5-2	How to Use the Multi-SP Function.	78
4-5-3	Settings	79
4-5-4	Executing Run/Stop Control.	79
4-5-5	Switching between Auto and Manual Control	80
4-5-6	Controlling the Start of the Simple Program Function.	80
4-6	Setting the SP Upper and Lower Limit Values	81
4-6-1	Set Point Limiter.	81
4-6-2	Setting.	81
4-7	Using the SP Ramp Function to Limit the SP Change Rate	82
4-7-1	SP Ramp	82
4-8	Moving to the Advanced Function Setting Level	84
4-9	Using the Key Protect Level	85
4-9-1	Protection	85
4-9-2	Entering the Password to Move to the Protect Level	87
4-10	PV Change Color	89
4-10-1	PV Color Change Function.	89
4-10-2	Setting.	90
4-11	Alarm Delays	92
4-11-1	Alarm Delays	92
4-12	Loop Break Alarm	94
4-12-1	Loop Break Alarm (LBA).	94
4-13	Performing Manual Control	97
4-13-1	Manual Operation	97

4-14	Using the Transfer Output	101
4-14-1	Transfer Output Function	101
4-15	Using the Simple Program Function	104
4-15-1	Simple Program Function	104
4-15-2	Operation at the Program End	107
4-15-3	Application Example Using a Simple Program	109
4-16	Output Adjustment Functions	110
4-16-1	Output Limits	110
4-16-2	MV at Stop	110
4-16-3	MV at PV Error	111

4-1 Shifting Input Values

4-1-1 Shifting Inputs

The input shift matched to the sensor currently selected in the “input type” parameter is displayed.

- A 2-point shift is applied for infrared temperature sensors. A 2-point shift can also be used if the “input shift type” parameter (advanced function setting level) is set to INS2 for a thermocouple or platinum resistance thermometer.

One-point shift



- With a 1-point shift, the value set for the “temperature input shift” parameter (adjustment level) is applied to each point in the entire temperature input range. For example, if the input shift value is set to 1.2°C, the process value is treated as 201.2°C after the input shift is applied when the measured process value is 200°C.

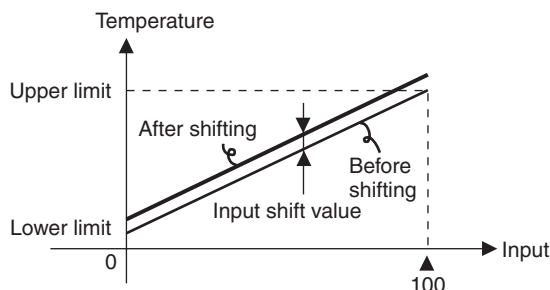

Operating Procedure

In this example, the input from a K sensor is shifted by 1°C using a 1-point input shift.

Operation Level

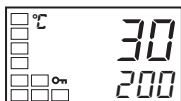

Operation Level

Adjustment Level

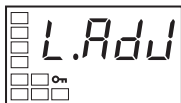

1. Press the key to move from the operation level to the adjustment level.

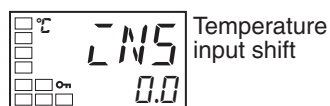

2. Select the “temperature input shift” parameter by pressing the key.

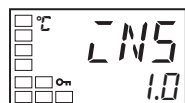

3. Press the or key to set 1.0.

Operation Level

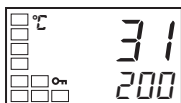

4. To return to the operation level, press the key. The process value is 1°C larger than before the shift was applied.

Two-point shift

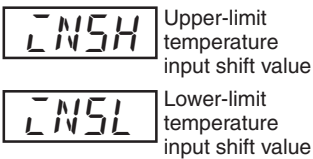

- Separate shift values can be set for the upper limit and lower limit of the sensor input range for an infrared sensor as well as for a thermocouple or platinum resistance thermometer with the “input shift type” set to INS2. If different shift values are set for the upper limit and lower limit, then the slope of the line will be different before and after applying the input shift. For example, if the upper-limit value is set to 2°C and the lower-limit value is set to 1°C, the input temperature will be shifted by 1.5°C for a 50% input, i.e., by the average of the upper-limit and lower-limit values.
- Set the upper-limit value in the “upper-limit temperature input shift value” parameter and the lower-limit value in the “lower-limit temperature input shift value” parameter.

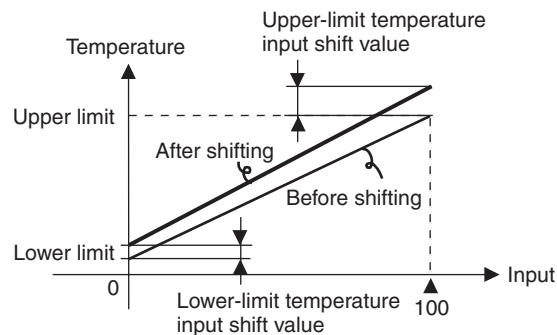

4-1-2 How to Calculate Input Shift Values for a 2-point Shift

When an ES1B Infrared Temperature Sensor is connected to the E5CN, an offset of several degrees to several tens of a degree can occur.

For this reason, offset the readout value using a 1-point or 2-point shift as described in this section. This offset occurs because a bias current for detecting a Controller sensor error flows to the output impedance of the infrared temperature sensor.

Preparations

- 1,2,3... 1. Set a temperature range matching the input specifications of the infrared temperature sensor. (The ES1B can be used with the E5AN only for a thermocouple/resistance thermometer multi-input type input.)
2. Prepare a thermometer capable of measuring the temperature of the control target as shown in *Figure 1* so that a 1-point shift or 2-point shift can be carried out.
3. The E5□N-□□P□ has a built-in external power supply for ES1B Infrared Temperature Sensors. These E5CN models can be used as the power supply when using ES1B. When ES1B are used with other E5CN models, provide a separate power supply for the Infrared Temperature Sensors.

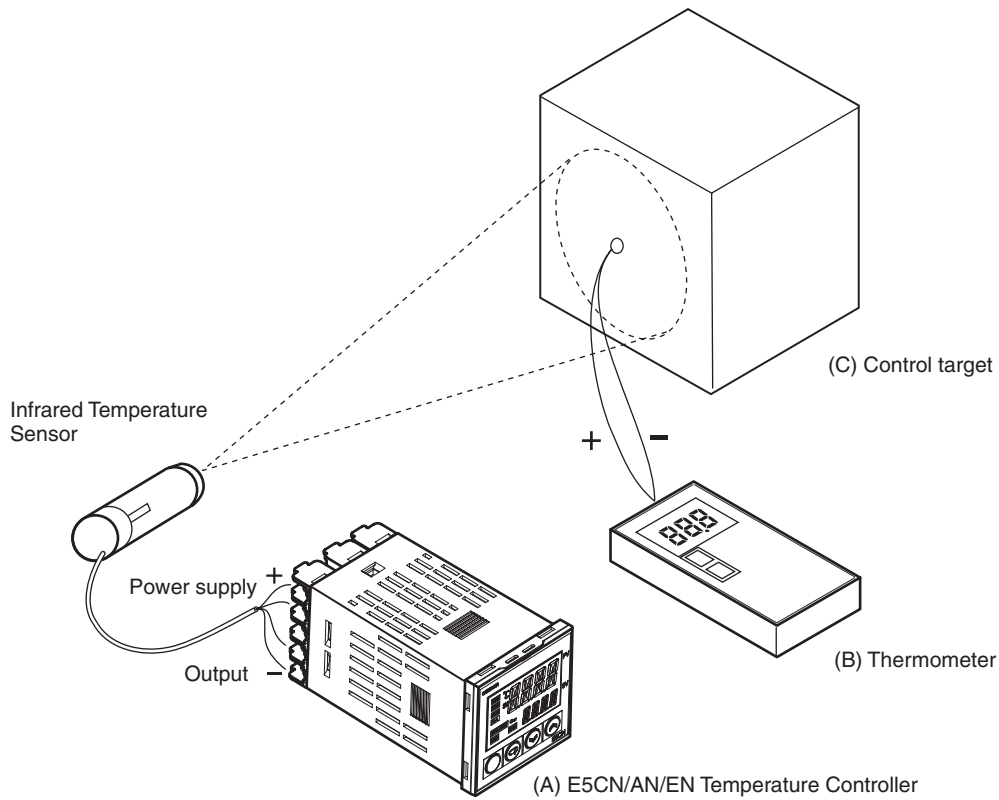

Figure 1 Offset Configuration for an Infrared Temperature Sensor

Method for a 1-point Shift

1,2,3...

1. In the configuration shown in *Figure 1*, bring the set point to near the value at which the temperature of the control target is to be controlled. Assume that the control target temperature (C) and the thermocouple temperature (B) are the same.
2. Check the control target temperature (B) and the Controller readout (A). Subtract the Controller readout temperature (A) from the control target temperature (B), and set $\bar{L}NSL$ and $\bar{L}NSH$ to the result as the input shift value. The shift is illustrated in *Figure 2*.
3. After setting the input shift values, check the Controller readout (A) and the control target temperature (B). If they are almost the same, this completes shifting the temperature input.

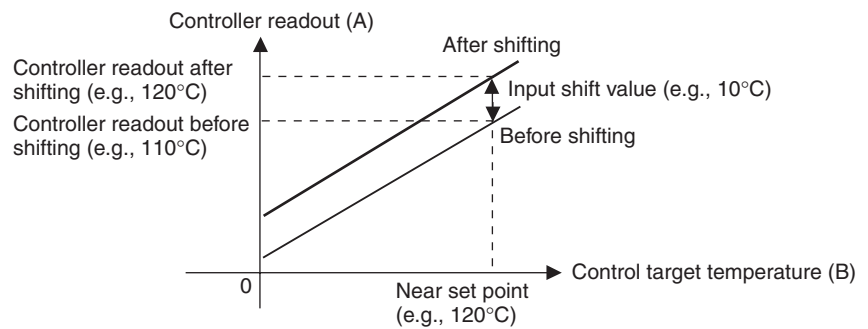
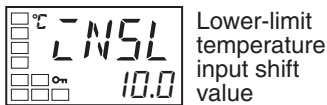
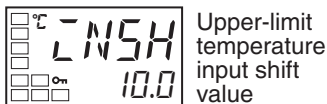

Figure 2 Illustration of 1-Point Shift

Method for a 2-point Shift

Use a 2-point input shift if you want to increase the accuracy of the readout values across the range of the sensor.

1,2,3...

1. Shift the Controller readout at two points, near room temperature and near the value at which the temperature of the control target is to be controlled. For this reason, check the control target temperature (B) and Controller readout (A) with the control object temperature near room temperature and near the set point.
2. Then use the following formulas to calculate the upper-limit and lower-limit temperature input shift values based on the readout temperatures and desired temperatures.

The shift is illustrated in Figure 3.

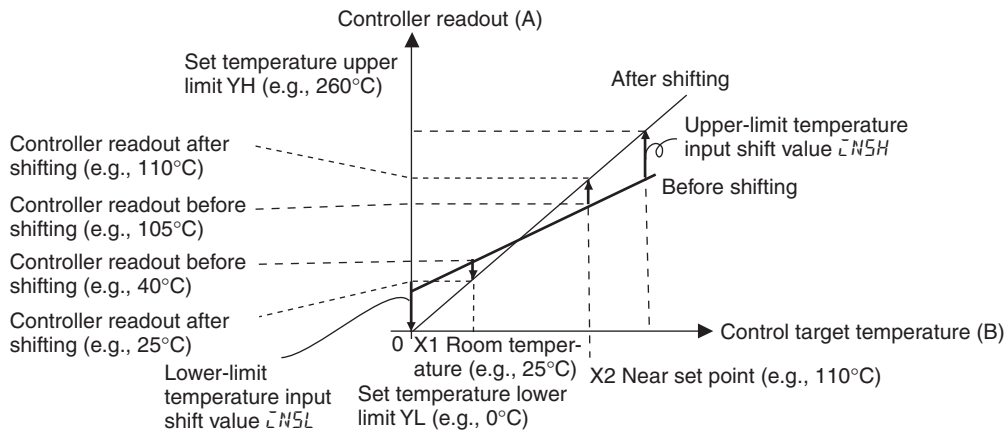

Figure 3 Illustration of 2-Point Shift

- a. Lower-limit temperature input shift value

$$\Delta NSL = \frac{YL - Y1}{Y2 - Y1} \times \{(X2 - Y2) - (X1 - Y1)\} + (X1 - Y1)$$

- b. Upper-limit temperature input shift value

$$\Delta NSH = \frac{YH - Y1}{Y2 - Y1} \times \{(X2 - Y2) - (X1 - Y1)\} + (X1 - Y1)$$

3. After setting the calculated values to ΔNSL and ΔNSH , check the Controller readout (A) and control target temperature (B).
4. Here, offsets are set at two points, near room temperature and near the set point. To improve accuracy within the measurement temperature range, another point in the measurement temperature range other than the set point should be set instead of room temperature.

Example of a 2-point Temperature Input Shift

In this example, we use the ES1B K 140 to 260°C specification. In equations 1 and 2, the set temperature lower limit YL is 0°C and the set temperature upper limit YH is 260°C. Check the temperature of the control target.

The temperature input offset values can be calculated as shown below when the Controller readout Y1 is 40°C for a room temperature X1 of 25°C and when the Controller readout Y2 is 105°C for a set point temperature X2 of 110°C.

Lower-limit Temperature Input Shift Value

$$\Delta NSL = \frac{0 - 40}{105 - 40} \times \{(110 - 105) - (25 - 40)\} + (25 - 40) = -27.3 \text{ (}^\circ\text{C)}$$

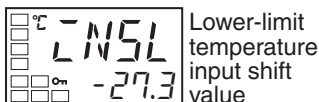

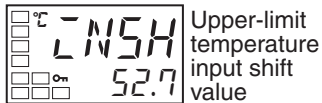

Upper-limit temperature input shift value

Upper-limit Temperature Input Shift Value

$$\bar{LNSH} = \frac{260 - 40}{105 - 40} \times \{(110 - 105) - (25 - 40)\} + (25 - 40) = 52.7 \text{ (}^\circ\text{C)}$$

4-2 Alarm Hysteresis

- The hysteresis of alarm outputs when alarms are switched ON/OFF can be set as follows:

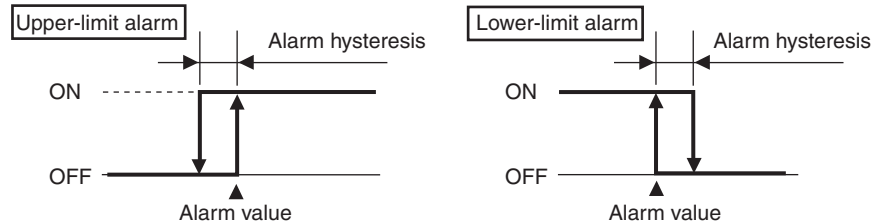

- Alarm hysteresis is set independently for each alarm in the “alarm hysteresis 1” to “alarm hysteresis 3” parameters (advanced function setting level).
- The default is 0.2 (°C/°F) for Controllers with Thermocouple/Resistance Thermometer Multi-Inputs and 0.02% FS for Controllers with Analog Inputs.

4-2-1 Standby Sequence

- The standby sequence can be used so that an alarm will not be output until the process value leaves the alarm range once and then enters it again.
- For example, with a lower limit alarm, the process value will normally be below the set point, i.e., within the alarm range, when the power supply is turned ON, causing an alarm to be output. If the lower limit alarm with a standby sequence is selected, an alarm will not be output until the process value increases above the alarm set value, i.e., until it leaves the alarm range, and then falls back below the alarm set value.

Restart

- The standby sequence is canceled when an alarm is output. It is, however, restarted later by the “standby sequence reset” parameter (advanced function setting level). For details, refer to the “standby sequence reset” parameter in *SECTION 5 Parameters*.

4-2-2 Alarm Latch

- The alarm latch can be used to keep the alarm output ON regardless of the temperature once the alarm output has turned ON. The alarm output will turn OFF when the power is turned OFF.
- (The alarm output can also be turned OFF by switching to the initial setting level, communications setting level, advanced function setting level, or calibration level.)

4-2-3 Close in Alarm/Open in Alarm

- When “close in alarm” is set, the status of the alarm output function will be output as is. When “open in alarm” is set, the status of the alarm output function will be reversed before being output.
- Close in alarm/open in alarm can be set separately for each alarm.
- Close in alarm/open in alarm is set in the “alarm 1 open in alarm” to “alarm 3 open in alarm” parameters (advanced function setting level).
- The default is $\bar{N}-\bar{o}$ (close in alarm).
- When “alarm 1 open in alarm” (advanced function setting level) is set to “open in alarm,” the heater burnout alarm and input error output are also set to “open in alarm.”

Setting	Alarm output function	Alarm output	Alarm indicator
Close in alarm	ON	ON	Lit
	OFF	OFF	Not lit
Open in alarm	ON	OFF	Lit
	OFF	ON	Not lit

- The alarm outputs will turn OFF (i.e., the relay contacts will open) when power is interrupted and for about two seconds after the power is turned ON regardless of the close in alarm/open in alarm setting.

Summary of Alarm Operation

The following figure summarizes the operation of alarms when the alarm type is set to “lower-limit alarm with standby sequence” and “close in alarm” is set.

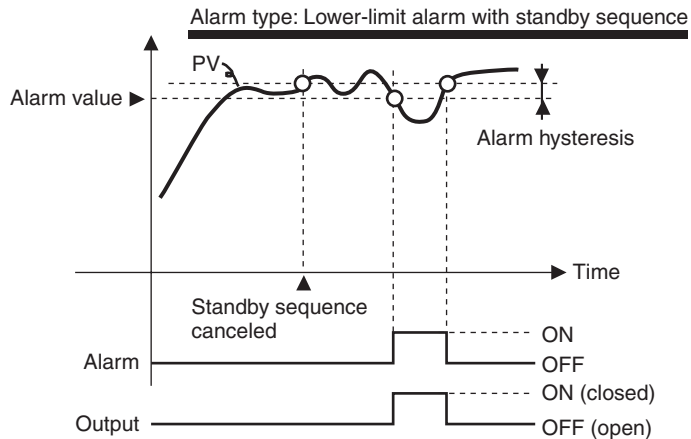

Parameters

Symbol	Parameter: Level	Description
RLH^*	Alarm 1 to 3 hysteresis: Advanced function setting level	Alarm
$RESL$	Standby sequence: Advanced function setting level	Alarm
RL^*N	Alarm 1 to 3 open in alarm: Advanced function setting level	Alarm

Note * = 1 to 3

4-3 Setting Scaling Upper and Lower Limits for Analog Inputs

4-3-1 Analog Input

Scaling upper limit

Scaling lower limit

Decimal point

- When an analog input is selected, scaling can be performed as needed by the control application.
- Scaling is set in the “scaling upper limit,” “scaling lower limit,” and “decimal point” parameters (initial setting level). These parameters cannot be used when a temperature input is selected.
- The “scaling upper limit” parameter sets the physical quantity to be expressed by the upper limit value of input, and the “scaling lower limit” parameter sets the physical quantity to be expressed by the lower-limit value of input. The “decimal point” parameter specifies the number of digits below the decimal point.
- The following figure shows a scaling example for a 4 to 20 mV input. After scaling, the humidity can be directly read. Here, one place below the decimal point is set.

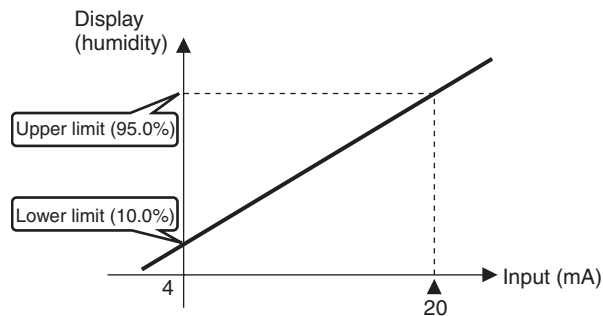

Operating Procedure

Initial Setting Level

Input type

Scaling upper limit

Scaling lower limit

Decimal point

In this example scaling is set to display 4 to 20 mA as 10.0% to 95.0%.

1. Press the key for three seconds to move from the operation level to the initial setting level.
2. Select “scaling upper limit” by pressing the key.
3. Use the and keys to set the parameter to 950.
4. Select the “scaling lower limit” parameter by pressing the key.
5. Press the and keys to set 100.
6. Select the “decimal point” parameter by pressing the key.

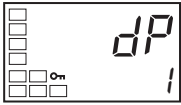

7. Press the and keys to set 1.

8. To return to the operation level, press the key for one second.

4-4 Executing Heating/Cooling Control

4-4-1 Heating/Cooling Control

Heating/cooling control can be used on the E5□N-□2□□□, E5□N-□3□□□, or E5□N-□Q□□□. Heating/cooling control operates when H- \bar{L} (heating/cooling) is selected for the “standard or heating/cooling” parameter.

The following functions are assigned to outputs in the initial status.

Parameter name	Symbol	Initial status
Control output 1 assignment	$\bar{OUT}1$	Control output for heating
Control output 2 assignment	$\bar{OUT}2$	Not assigned.
Alarm 1 assignment	$ALM1$	Alarm 1
Alarm 2 assignment	$ALM2$	Alarm 2
Alarm 3 assignment (E5AN/EN only)	$ALM3$	Alarm 3

Each output is automatically initialized as shown below when the control mode is changed.

Example: E5CN

Parameter name	Symbol	Without control output 2		With control output 2	
		Standard	Heating/cooling	Standard	Heating/cooling
Control output 1 assignment	$\bar{OUT}1$	Control output for heating	Control output for heating	Control output for heating	Control output for heating
Control output 2 assignment	$\bar{OUT}2$	Not assigned. (See note 1.)	Not assigned. (See note 1.)	Not assigned.	Control output for cooling
Alarm 1 assignment	$ALM1$	Alarm 1 (See note 2.)	Alarm 1 (See note 2.)	Alarm 1 (See note 2.)	Alarm 1 (See note 2.)
Alarm 2 assignment	$ALM2$	Alarm 2 (See note 3.)	Control output for cooling (See note 3.)	Alarm 2	Alarm 2

- Note**
- (1) No parameter assignment is displayed because there is no control output 2.
 - (2) Alarm 1 becomes the program END output unless the program pattern is OFF.
 - (3) For the E5AN/EN, alarm 3 is assigned for control output (cooling) (alarm output 2 is assigned for alarm 2).
 - The heating/cooling operation of the control outputs will switch when the “direct/reverse operation” parameter is set to “direct.”
 - When heating/cooling control is selected, the “dead band” and “cooling coefficient” parameters can be used.

In this manual, assigned control outputs and alarm outputs are indicated as follows: “Control output 1 must be assigned” or “Alarm 1 must be assigned.”

Dead Band

- For heating/cooling control, the dead band is set with the set point as its center. The dead band width is the set value of the “dead band” parameter (adjustment level). Setting a negative value produces an overlapping band.
- If an overlapping band is set, the bumpless function may not operate when switching between manual operation and automatic operation.
- The default is 0.0 EU for Controllers with Thermocouple/Resistance Thermometer Multi-Inputs and 0.00% FS for Controllers with Analog Inputs.

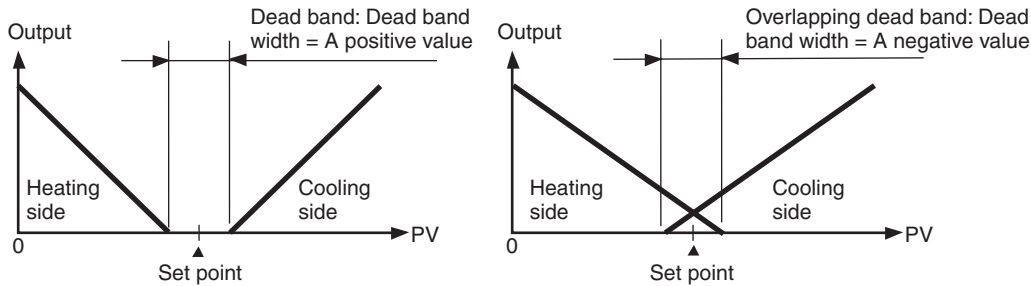

Cooling Coefficient

If the heating characteristics and cooling characteristics of the control object are very different and good control characteristics cannot be achieved with the same PID constants, the cooling coefficient can be used to adjust the proportional band (P) for the control output assigned to the cooling side. Use this to achieve balanced control between the heating side and cooling side. The proportional bands (P) for the control outputs assigned to the heating/cooling sides can be calculated using the following equations.

P for control output assigned to heating side = P

P for control output assigned to cooling side = P for control output assigned to heating side × cooling coefficient

The cooling coefficient is multiplied by the P for the control output assigned to the heating side to obtain control with characteristics that differ from those of the control output assigned to the heating side.

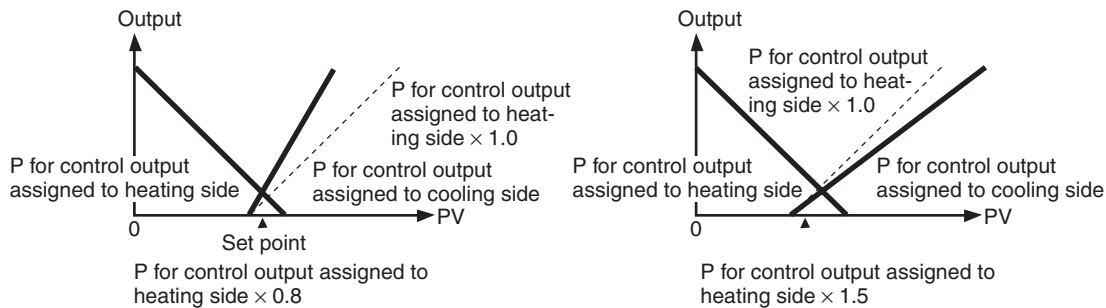

4-4-2 Settings

To set heating/cooling control, set the “standard or heating/cooling,” “dead band,” and “cooling coefficient” parameters.

Setting Heating/Cooling Control

Operating Procedure

Standard or heating/cooling = Heating/cooling

Initial Setting Level

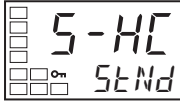

Standard or heating/cooling

1. Press the key for at least three seconds to move from the operation level to the initial setting level.

2. Select “heating/cooling control” in the initial setting level.

StNd: Standard control

H-C: Heating/cooling control

Setting the Cooling Coefficient

Operating Procedure

Cooling Coefficient = 10

Adjustment Level



Cooling coefficient

1. Select the “cooling coefficient” in the adjustment level.



2. Use the key to set the parameter to 10.00.

Setting the Dead Band

Operating Procedure

Dead Band = 5

Adjustment Level

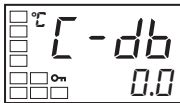

Dead band

1. Select the “dead band” parameter in the adjustment level.

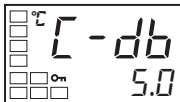

2. Use the key to set the parameter to 5.0.

4-5 Using Event Inputs

4-5-1 Event Input Settings

- Event inputs can be used for the multi-SP function, starting/stopping operation (RUN/STOP), switching between auto/manual, and program starts.
- Of these, the multi-SP function, event inputs are used only for the number (0 to 2) set in the “number of multi-SP uses” parameter (advanced function level).
- Event inputs (1 and 2) that are not used for the multi-SP function are assigned using the “event input assignment 1” and “event input assignment 2” parameters (advanced function level).
- Event inputs can be used on E5□N-□□□B□ Controllers.

Parameter		Setting		Event inputs	
		Event input assignment 1	Event input assignment 2	Function of event input 1	Function of event input 2
Number of multi-SP uses	0 (See note 1.)	NONE, STOP, MANU, PRST (See note 2.)		None, or switching RUN/STOP, switching auto/manual, or starting/resetting program	
	1	(Not displayed.)	NONE, STOP, MANU, PRST (See note 2.)	Multi-SP, 2 points (switching set points 0 and 1)	None, or switching RUN/STOP, auto/manual, or program starts
	2	(Not displayed.)		Multi-SP, 4 points (switching set points 0, 1, 2, 3)	

- Note**
- (1) If the “number of multi-SP uses” is set to 0, and both input assignments 1 and 2 can be set. Once “STOP” (RUN/STOP), “MANU” (auto/manual), or “PRST” (program start) has been assigned to one event input, the other event can be assigned only to either of the remaining two settings.
 - (2) “PRST” (program start) can be set only when the “program pattern” parameter has not be set to OFF.
If the “program pattern” parameter is set to OFF (i.e., if the simple program mode is not selected) when “PRST” (program start) is set, the assignment of the input will automatically be changed to “NONE.”

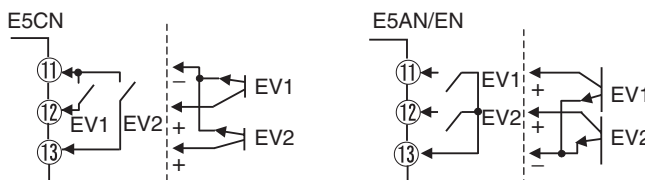

When you are setting two externally input set points, set in the “number of multi-SP uses” parameter.

- Switching is possible between two set points (0 and 1) by setting the “number of multi-SP uses” parameter to 1.
The default setting is 1 and does not need to be changed to switch between two set points.
Set point 0 or 1 is specified by the ON/OFF state of event input 1.

4-5-2 How to Use the Multi-SP Function

The multi-SP function allows you to set up to four set points (SP 0 to 3) in the adjustment level. The set point can be switched by operating the keys on the front panel or by using external input signals (event inputs).

Using Event Inputs

Event inputs can be used if the Controller supports the event input function and if the “number of multi-SP uses” parameter is set to 1 or 2.

■ Number of Multi-SP Uses = 1

Event input 1	Selected set point
OFF	Set point 0
ON	Set point 1

■ Number of Multi-SP Uses = 2

Event input 1	Event input 2	Selected set point
OFF	OFF	Set point 0
ON	OFF	Set point 1
OFF	ON	Set point 2
ON	ON	Set point 3

Note Event inputs can be used on E5□N-□□□B□ Controllers. Turn the event inputs ON or OFF while the E5AN is turned ON. Event input ON/OFF changes are detected for inputs of 50 ms or longer.

Using Key Operations

You can select any of the set points 0 to 3 by changing the set value of the “multi-SP uses” parameter. The “multi-SP uses” display conditions are as follows:

- If the Controller does not support event inputs, the “multi-SP uses” parameter must be set to ON.
- If the Controller supports event inputs, the “number of multi-SP uses” parameter must be set to 0 and the “multi-SP uses” parameter must be set to ON.

The following table shows the relationship between the “multi-SP uses” parameter set value and the selected set point.

Multi-SP	Selected set point
0	Set point 0
1	Set point 1
2	Set point 2
3	Set point 3

Note The set point can also be switched using communications.

4-5-3 Settings

Switching between Set Points 0, 1, 2, and 3

Operating Procedure

The following example sets the “number of multi-SP uses” parameter to 2.

Operation Level



1. Press the key for at least three seconds to move from the operation level to the initial setting level.

Initial Setting Level

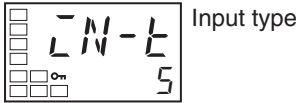

2. Select the “move to advanced function setting level” parameter by pressing the key.

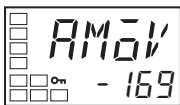

3. Use the key to enter “-169” (the password).

Advanced Function Setting Level

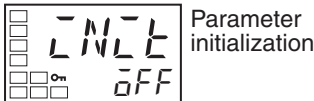

Move to the advanced function setting level by pressing the key or leaving the setting for at least two seconds.

Number of Multi-SP Uses Setting

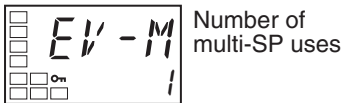

4. Select the “number of multi-SP uses” parameter by pressing the key.

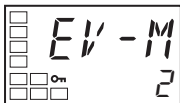

5. Use the key to set the parameter to 2.
6. To return to the initial setting level, press the key for at least one second.
7. To return to the operation level, press the key for at least one second.

Set points 0, 1, 2 and 3 will be set according to the ON/OFF states of event inputs 1 and 2.

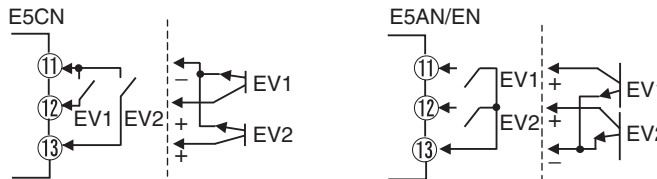

4-5-4 Executing Run/Stop Control

When the “event input assignment 1” or “event input assignment 2” parameter is set to STO (RUN/STOP), control is started when event input 1 or 2 turns OFF. Control is stopped when the input turns ON. Alarm outputs, however, will be according to the process value.

The STOP indicator will light while control is stopped.

Setting	Input contact	Status
Event input 1 or 2	ON	STOP
Event input 1 or 2	OFF	RUN

4-5-5 Switching between Auto and Manual Control

When the “event input assignment 1” or “event input assignment 2” parameter is set to MANU (auto/manual), manual control will start when event input 1 or 2 turns ON. Auto control will start when the input turns OFF.

The MANU indicator will light during manual control.

Setting	Input contact	Status
Event input 1 or 2	OFF	Automatic
Event input 1 or 2	ON	Manual

4-5-6 Controlling the Start of the Simple Program Function

When the “event input assignment 1” or “event input assignment 2” parameter is set to PRST (program start), the program will start when event input 1 or 2 turns ON. The program will be reset when the input turns OFF and the RUN/STOP status will automatically switch to STOP mode. If the program END output is ON, the program END output will turn OFF.

Setting	Input contact	Status
Event input 1 or 2	OFF	Reset
Event input 1 or 2	ON	Start

Note The specified event input function can be used when the “number of multi-SP uses” parameter is set to 0 or 1 (i.e., when it is not set for the set point setting).

Event input assignments 1 and 2 are as follows according to the setting of the “number of multi-SP uses” parameter:

Parameter	Setting		Event inputs		
	Event input assignment 1	Event input assignment 2	Function of event input 1	Function of event input 2	
Number of multi-SP uses	0	Event input assignment (See note.)	Event input assignment (See note.)	Specified event input function	Specified event input function
		NONE	Event input assignment	None	Specified event input function
		Event input assignment	NONE	Specified event input function	None
		NONE	NONE	None	None
	1	--- (Setting data not displayed.)	Event input assignment	Multi-SP, 2 points (switching set points 0 and 1)	Specified event input function
		--- (Setting data not displayed.)	NONE	Multi-SP, 2 points (switching set points 0 and 1)	None
2	--- (Setting data not displayed.)	--- (Setting data not displayed.)	Multi-SP, 4 points (switching set points 0, 1, 2, 3)		

Note One of the settings.

Parameters

Symbol	Parameter: Level	Description
<i>EV-1</i>	Event input assignment 1: Advanced function setting level	Function of event input function
<i>EV-2</i>	Event input assignment 2: Advanced function setting level	
<i>EV-M</i>	Number of multi-SP uses: Advanced function setting level	

4-6 Setting the SP Upper and Lower Limit Values

4-6-1 Set Point Limiter

The setting range of the set point is limited by the set point limiter. The set point limiter is used to prevent the control target from reaching abnormal temperatures. The upper- and lower-limit values of the set point limiter are set using the “set point upper limit” and “set point lower limit” parameters in the initial setting level. When the set point limiter is reset, the set point is forcibly changed to the upper- or lower-limit value of the set point limiter if the set point is out of the limiter range. Also, when the input type and temperature unit are changed, the set point limiter is forcibly reset to the sensor setting range.

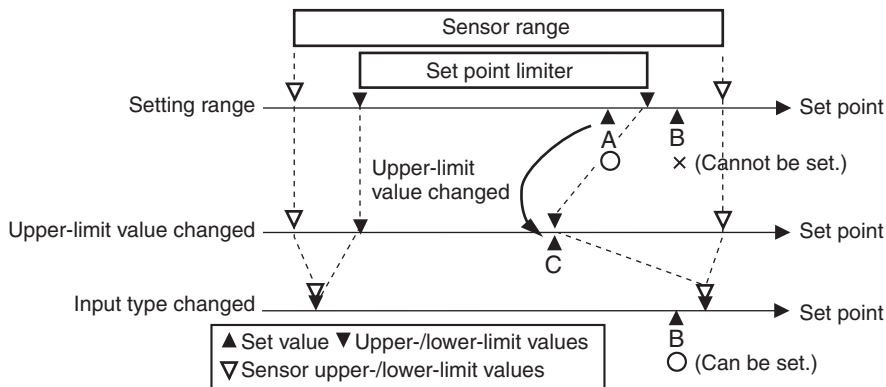

Parameters

Symbol	Parameter: Level	Description
SL-H	Set point upper limit: Initial setting level	To limit the SP setting
SL-L	Set point lower limit: Initial setting level	To limit the SP setting

4-6-2 Setting

Set the set point upper and lower limits in the “set point upper limit” and “set point lower limit” parameters in the initial setting level. In this example, it is assumed that the input type is set to a K thermocouple with a temperature range of -200 to 1300°C.

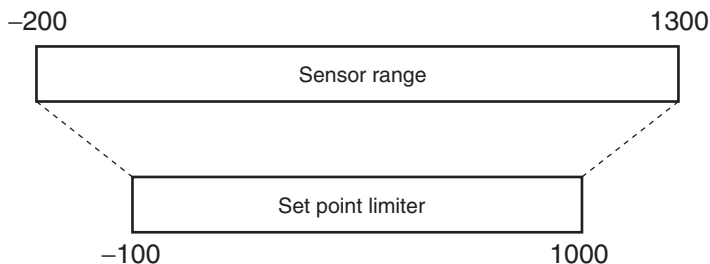

Setting the Set Point Upper-limit Value

Operating Procedure

Set Point Upper Limit = 1000

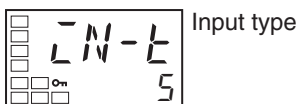

1. Press the key for at least three seconds to move from the operation level to the initial setting level.

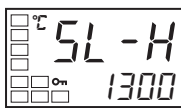

Set point upper-limit

2. Select the “set point upper limit” parameter.

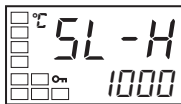

3. Use the \uparrow and \downarrow keys to set the parameter to 1000.

Setting the Set Point Lower-limit Value

Operating Procedure

Set Point Lower Limit = -100

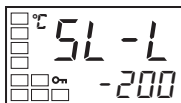

Set point lower limit

1. Select the “set point lower limit” parameter in the initial setting level.

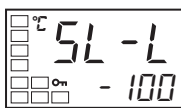

2. Use the \uparrow and \downarrow keys to set the parameter to -100.

4-7 Using the SP Ramp Function to Limit the SP Change Rate

4-7-1 SP Ramp

The SP ramp function is used to restrict the width of changes in the set point as a rate of change. When the SP ramp function is enabled and the change width exceeds the specified rate of change, an area where the set point is restricted will be created, as shown in the following diagram.

During the SP ramp, control will be performed not for the specified set point but rather for the set point restricted by the rate of change set for the SP ramp function.

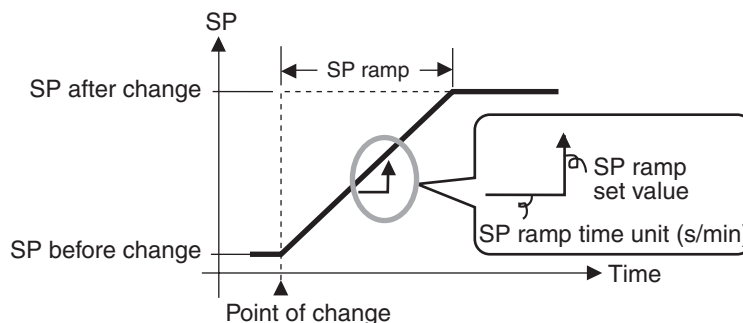

The rate of change during SP ramp is specified using the “SP ramp set value” and “SP ramp time unit” parameters. The “SP ramp set value” parameter is set to OFF by default, i.e., the SP ramp function is disabled.

Changes in the ramp set point can be monitored in the “Set point during SP ramp” parameter (operation level). Use this parameter when monitoring SP ramp operation.

The SP ramp function operates in the same way when switching the set point using the multi-SP function.

Parameters

Symbol	Parameter: Level	Description
$\bar{a}L-H$	MV upper limit: Adjustment level	To limit the manipulated variable
$\bar{a}L-L$	MV lower limit: Adjustment level	To limit the manipulated variable
$SL-H$	Set point upper limit: Initial setting level	To limit the SP setting
$SL-L$	Set point lower limit: Initial setting level	To limit the SP setting
$SPRE$	SP ramp set value: Adjustment level	To limit the SP rate of change
$SPRU$	SP ramp time unit: Advanced function setting level	Unit for setting the SP
$RLSP$	Alarm SP selection: Advanced function setting level	Alarm SP selection

Operation at Startup

If the SP ramp function is enabled when the Controller is turned ON or when switching from STOP to RUN mode, the process value may reach the set point using the SP ramp function in the same way as when the set point is changed. In this case, operation is carried out with the process value treated as the set point before the change was made. The direction of the SP ramp changes according to the relationship between the process value and the set point.

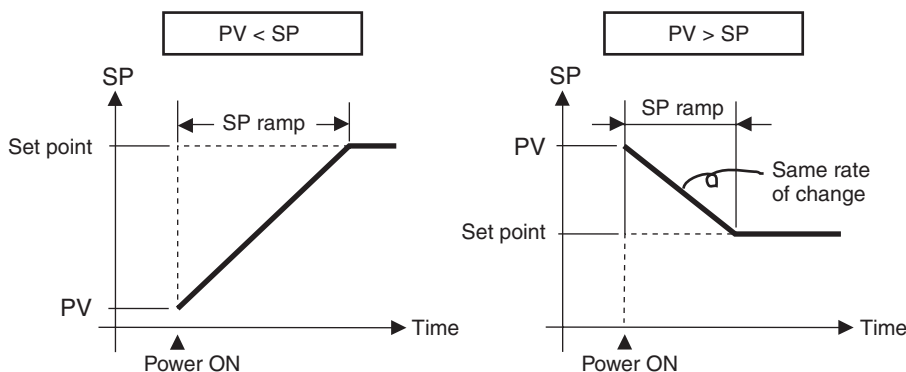

Restrictions during SP Ramp Operation

- Execution of auto-tuning starts after the end of the SP ramp.
- When control is stopped or an error occurs, the SP ramp function is disabled.

Alarms during SP Ramp Operation

The operation of alarms during SP ramp operation depends on whether alarms are set to be based on the ramp set point or the target set point (refer to the following diagrams). The set point to be used is set in the “alarm SP selection” parameter.

Alarm SP Selection = Ramp SP (Alarm Type: 1 (Upper/Lower Limits))

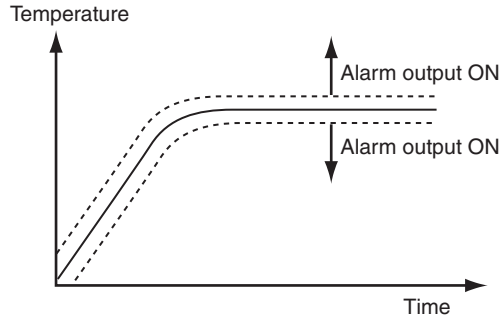

Alarm SP Selection = Target SP (Alarm Type: 1 (Upper/Lower Limits))

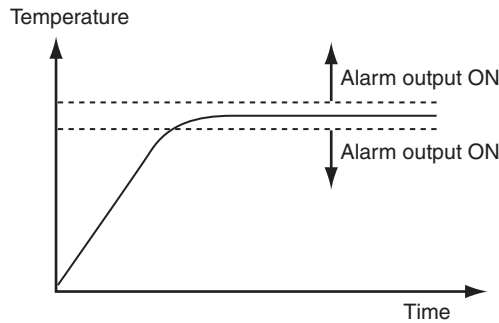

4-8 Moving to the Advanced Function Setting Level

To move to the advanced function setting level, you must first cancel the protection applied by the “initial setting/communications protect” parameter. In the default setting, the advanced function setting level is protected and you cannot move to this setting level.

1,2,3...

1. Press the and keys simultaneously for at least three seconds in operation level.

Note The key pressing time can be changed in the “move to protect level time” parameter (advanced function setting level).

2. The Controller moves to the protect level, and the “operation/adjustment protect” parameter is displayed.

Protect Level



Operation/adjustment protect



Initial setting/communications protect



3. Press the key once to move to the “initial setting/communications protect” parameter.

4. Set the set value to 0.

Operation Level



5. Press the and keys simultaneously for at least one second to return to the operation level.

Initial Setting Level

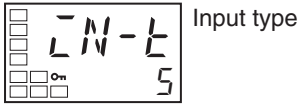

6. Move to the advanced function setting level. Press the key for at least three seconds to move from the operation level to the initial setting level.

Initial Setting Level

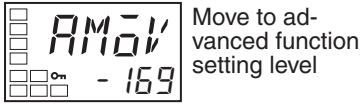

7. Select the “move to advanced function setting level” parameter by pressing the key.

Advanced function setting level

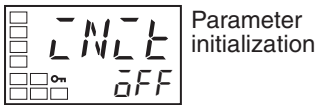

8. Press the key, enter the password (-169), and then either press the key or leave the setting for at least two seconds to move to the advanced function setting level from the initial setting level.

Initial Setting Level

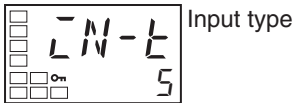

9. To return to the initial setting level, press the key for at least one second.

Operation Level



10. To return to the operation level, press the key for at least one second.

4-9 Using the Key Protect Level

4-9-1 Protection

- To move to the protect level, press the and keys simultaneously for at least three seconds in operation level or adjustment level. (See note.)

Note The key pressing time can be changed in the “move to protect level time” parameter (advanced function level).

- The protect level protects parameters that are not changed during Controller operation until operation is started to prevent them from being modified unintentionally.

There are three types of protection: operation/adjustment protect, initial setting/communications protect, and setting change protect.

- The protect level settings restrict the range of parameters that can be used.

Operation/Adjustment Protect



The following table shows the relationship between set values and the range of protection.

Level		Set value			
		0	1	2	3
Operation level	PV	Can be displayed	Can be displayed	Can be displayed	Can be displayed
	PV/SP	Can be displayed and changed	Can be displayed and changed	Can be displayed and changed	Can be displayed
	Others	Can be displayed and changed	Can be displayed and changed	Cannot be displayed and moving to other levels is not possible	Cannot be displayed and moving to other levels is not possible
Adjustment level		Can be displayed and changed	Cannot be displayed and moving to other levels is not possible	Cannot be displayed and moving to other levels is not possible	Cannot be displayed and moving to other levels is not possible

- Parameters are not protected when the set value is set to 0.
- The default is 0.

Initial Setting/Communications Protect



This protect level restricts movement to the initial setting level, communications setting level, and advanced function setting level.

Set value	Initial setting level	Communications setting level	Advanced function setting level
0	Movement possible	Movement possible	Movement possible
1	Movement possible	Movement possible	Movement not possible
2	Movement not possible	Movement not possible	Movement not possible

- The default is 1.

Setting Change Protect

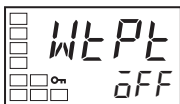

This protect level restricts key operations.

Set value	Description
OFF	Settings can be changed using key operations.
ON	Settings cannot be changed using key operations. (The protect level settings, however, can be changed.)

- The default is OFF.
- The all protect indication (On) will light when setting change protect is set.

4-9-2 Entering the Password to Move to the Protect Level

- Protect level can be moved to only by display the password display and entering the correct password. (The user can set any password in the “protect level password” parameter. If no password is set (i.e., if the password is set to 0 in the “protect level password” parameter), the password input display to move to protect level will not be displayed and the protect level can be moved to directly.

Operating Procedure

Use the following procedure to move to protect level.

■ Example with a Password of 1234

Operation Level



Protect Level

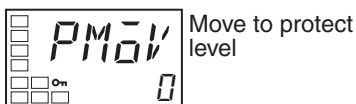

1. Press the and keys simultaneously for at least the time set in the “move to protect level time” parameter to move from the operation level to the protect level.

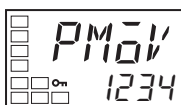

2. Press the key to set the parameter to 1234 (password input).

Protect Level

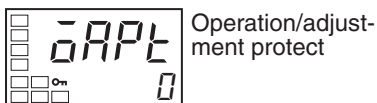

3. Move to the “operation/adjustment protect” parameter by pressing the or key or leaving the setting for at least two seconds.

■ Example with No Password Set

Operation Level



Protect Level

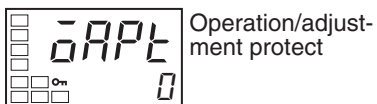

Press the and keys simultaneously for at least the time set in the “operation/adjustment protect” parameter to move from the operation level to the protect level.

When a password is not set, the “operation/adjustment protect” parameter will be displayed.

Setting the Password

Operating Procedure

Use the following procedure to set the password to move to the protect level.

■ Example To set the Password to 1234

Operation Level



Protect Level



1. Press the and keys simultaneously for at least the time set in the “move to protect level time” parameter to move from the operation level to the protect level.

Protect Level

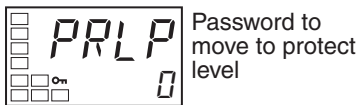

2. Select the “password to move to protect level” parameter by pressing the key.



3. Press the and keys to set the parameter to 1234. (To prevent setting the password incorrectly, the and keys or and keys must be pressed simultaneously to set the password.)

Note Protection cannot be cleared or changed without the password. Be careful not to forget it. If you forget the password, contact your OMRON sales representative.

Communications Operation Command to Move to the Protect Level

- The Write Variable operation command can be used via communications to write the password to the “move to protect level” parameter. When the correct password is written, the display will change to the “operation/adjustment protect” parameter and writing the parameters in the protect level will be enabled.

Note

- (1) If the Write Variable operation command is used to write the wrong password to the “move to protect level” parameter after the correct parameter has been written, the “move to protect level” parameter will be displayed and any Write Variable operation commands to write parameters in the protect level will result in operation errors.
- (2) If a password is not set or if it is set to 0, the display will change to the “operation/adjustment protect” parameter and writing the parameters in the protect level will be enabled immediately.

4-10 PV Change Color

4-10-1 PV Color Change Function

Use the PV color change function to change the color of the PV display (No. 1 display).

There are three display colors, orange, red, and green, and you can select from the following three modes and eight functions.



- Constant: This mode displays orange, red, or green all the time.
- Linked to Alarm 1: This mode switches the PV display color from red to green when alarm 1 turns ON or from green to red when alarm 1 turns ON.
- Linked to PV stable band: This mode switches the PV display color between red outside the PV stable band and green within PV stable band, or between green outside the PV stable band and red within PV stable band.
Set the PV stable band in the “PV stable band” parameter (advanced function setting level).
- The default is *REd* (red).

The following tables shows the display functions that can be set using the PV color change function.

Mode	Setting	Function	PV change color			Application example	
Constant	<i>āRĒ</i>	Orange	Constant: Orange			To match the display color with other Controller models	
	<i>REd</i>	Red	Constant: Red			To match the display color with other Controller models	
	<i>ĒRN</i>	Green	Constant: Green			To match the display color with other Controller models	
Linked to alarm 1							
			ALM1 not lit	ALM1 lit	Application example		
	<i>R-Ē</i>	Red to Green	Red	Green	To display the PV reached signal		
	<i>Ē-R</i>	Green to Red	Green	Red	To display error signals		
Linked to PV stable band							
			Low	Within PV stable band	High	Application example	
	<i>R-Ē,R</i>	Red to Green to Red	Red	Green	Red	To display stable status	
	<i>Ē-ā,R</i>	Green to Orange to Red	Green	Orange	Red	To display stable status	
	<i>ā-Ē,R</i>	Orange to Green to Red	Orange	Green	Red	To display stable status	

PV Stable Band



When the mode to link to the PV stable band is selected, the PV display color will change according to whether the present value (PV) is lower than, within, or higher than the PV stable band shown in the following figure. The PV stable band is set with the SP as the center, as shown below.

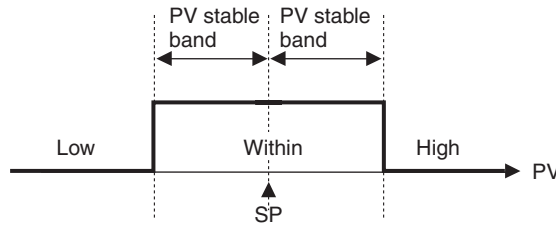

The default is 5.0 (°C/°F) for Controllers with Thermocouple/Resistance Thermometer Multi-Inputs and 5.0% FS for Controllers with Analog Inputs.

4-10-2 Setting

Setting the PV Change Color to Indicate Stable Status

To display the PV in a stable green display when the PV is within ±15.0°C of the set point to enable checking the control process at a glance, set the “PV change color” and “PV stable band” parameters.

PV change color = R - GR (Red to Green to Red)

PV stable band = 15.0°C

Operating Procedure

Release the protection before setting the “PV change color” and “PV stable band” parameters to enable moving to advanced function setting level. (Refer to steps 1 to 8 on page 84.)

Operation Level



Initial Setting Level

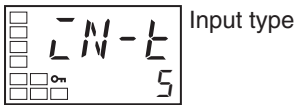

Initial Setting Level



Advanced Function Setting Level

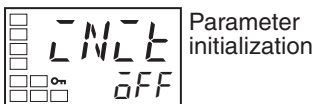

Advanced Function Setting Level

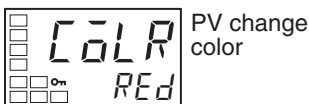

1. Press the key for at least three seconds to move from the operation level to the initial setting level.
2. Select the “move to advanced function setting level” parameter by pressing the key.
3. Use the key to enter “-169” (the password).
4. Select the “PV change color” parameter by pressing the key.

Move to the advanced function setting level by pressing the key or leaving the setting for at least two seconds.



5. Press the  key to set the parameter to *R-C.R.*

Advanced Function Setting Level

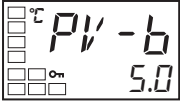

PV stable band

6. Select the "PV stable band" parameter by pressing the  key.

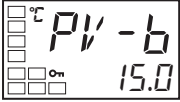

7. Use the  key to set the parameter to 15.0.

Operation Level

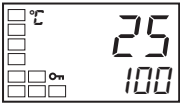

PV/SP

8. To return to the initial setting level, press the  key for at least one second.

9. To return to the operation level, press the  key for at least one second.

4-11 Alarm Delays

4-11-1 Alarm Delays

- Delays can be set for the alarm outputs. ON and OFF delays can be set separately for alarms 1, 2, and 3. The ON and OFF delays for alarm 1 function only for the alarm function. If the alarm output 1 is set to be output as an OR with other alarm functions (i.e., the heater burnout alarm, HS alarm, or input error output alarm), the delays will not function for the other alarms. The ON and OFF delays for alarms 1, 2, and 3 also apply to the individual ALM1, ALM2, and ALM3 indicators and to communications status. The alarm ON delays will also function when power is turned ON or when moving from initial setting level to operation level (i.e., to software resets). All outputs will turn OFF and the OFF delays will not function when moving to the initial setting level or when an alarm is output for a heater burnout error.

Operation of Alarm ON and OFF Delays (for an Upper-limit Alarm)

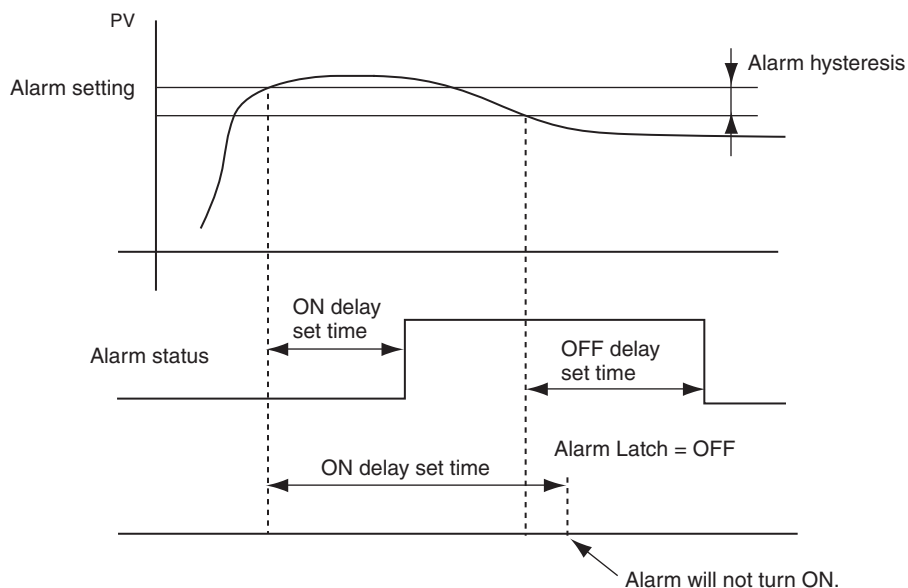

- The alarm will not turn ON if the time that the alarm is ON is equal to or less than the ON delay set time. Also, the alarm will not turn OFF if the time that the alarm is OFF is equal to or less than the OFF delay set time.
- If an alarm turns OFF and then back ON during the ON delay time, the time will be remeasured from the last time the alarm turns ON. Also, if an alarm turns ON and then back OFF during the OFF delay time, the time will be remeasured from the last time the alarm turns OFF.

Parameters Related to Alarm Delays

Parameter name	Symbol	Set (monitor) values
Alarm 1 ON delay	$R1\bar{o}N$	0 to 999 (s)
Alarm 2 ON delay	$R2\bar{o}N$	0 to 999 (s)
Alarm 3 ON delay	$R3\bar{o}N$	0 to 999 (s)
Alarm 1 OFF delay	$R1\bar{o}F$	0 to 999 (s)
Alarm 2 OFF delay	$R2\bar{o}F$	0 to 999 (s)
Alarm 3 OFF delay	$R3\bar{o}F$	0 to 999 (s)

- Note**
- (1) The defaults are 0, i.e., the ON and OFF delays are disabled.
 - (2) The parameters are displayed when alarm outputs are assigned and when the alarm type is set to any type but 0 (none).

Operating Procedure

Use the following procedure to set ON and OFF delays for the alarm 1 output. An ON delay of 5 seconds and an OFF delay of 10 s will be set.

Operation Level



Initial Setting Level

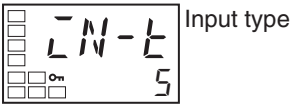

1. Press the key for at least three seconds to move from the operation level to the initial setting level.

Initial Setting Level



2. Select the “move to advanced function setting level” parameter by pressing the key.

Advanced Function Setting Level

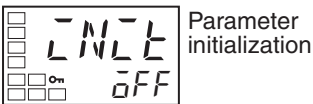

3. Press the key to enter the password (-169) and move from the initial setting level to the advanced function setting level.

Advanced Function Setting Level



4. Press the key to select the “alarm 1 ON delay” parameter.



5. Press the key to set the parameter to 5.

Advanced Function Setting Level



6. Press the key to select the “alarm 1 OFF delay” parameter.



7. Press the key to set the parameter to 10.

Initial Setting Level

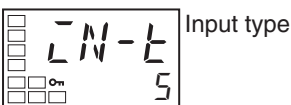

8. Press the key for at least one second to move from the advanced function setting level to the initial setting level.

Operation Level



9. Press the key for at least one second to move from the initial setting level to the operation level.

4-12 Loop Break Alarm

4-12-1 Loop Break Alarm (LBA)

- With a loop break alarm, there is assumed to be an error in the control loop if the control deviation ($SP - PV$) is greater than the threshold set in the “LBA level” parameter and if the control deviation is not reduced by at least the value set in the “LBA detection band” parameter within the LBA detection time.
- Loop break alarms are detected at the following times.

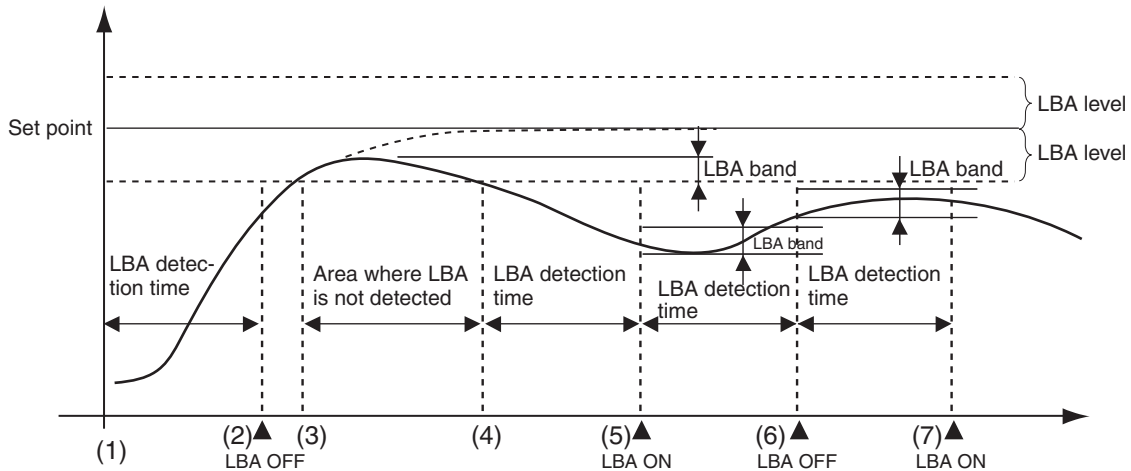

If the control deviation is reduced in the area between 1 and 2 (i.e., the set point is approached) and the amount the control deviation is reduced is at least equal to the LBA band, the loop break alarm will remain OFF.

The process value is within the LBA level between 3 and 4, and thus loop break alarms will not be detected. (The loop break alarm will remain OFF.)

If the process value is outside the LBA level between 4 and 5 and the control deviation is not reduced by at least the LBA band within the LBA detection time, the loop break alarm will turn ON.

If the control deviation is reduced in the area between 5 and 6 (i.e., the set point is approached) and the amount the control deviation is reduced is at least equal to the LBA band, the loop break alarm will turn OFF.

If the control deviation is reduced in the area between 6 and 7 (i.e., the set point is approached) and the amount the control deviation is reduced is less than the LBA band, the loop break alarm will turn ON.

- If the LBA detection time, LBA level, LBA detection band, and PID settings are not appropriate, alarms may be detected inappropriately or alarms may not be output when necessary.
- Loop break alarms may be detected if unexpectedly large disturbances occur continuously and a large deviation does not decrease.
- If a loop break occurs when the set point is near the ambient temperature, the temperature deviation in a steady state may be less than the LBA level, preventing detection of the loop break.
- If the set point is so high or low that it cannot be reached even with a saturated manipulated variable, a temperature deviation may remain even in a steady state and a loop break may be detected.

- Detection is not possible if a fault occurs that causes an increase in temperature while control is being applied to increase the temperature (e.g., an SSR short-circuit fault).
- Detection is not possible if a fault occurs that causes a decrease in temperature while control is being applied to decrease the temperature (e.g., a heater burnout fault).

Parameters Related to Loop Break Alarms

Parameter name	Symbol	Setting range		Remarks
LBA detection time	<i>LbR</i>	0 to 9999 (s)		Setting 0 disables the LBA function.
LBA level	<i>LbRL</i>	Controllers with Thermocouple/Resistance Thermometer Multi-inputs	0.1 to 999.9 (°C/°F) (See note.)	Default: 8.0 (°C/°F)
		Controllers with Analog Inputs	0.01 to 99.99 (%FS)	Default: 10.00% FS
LBA band	<i>LbRb</i>	Controllers with Thermocouple/Resistance Thermometer Multi-inputs	0.0 to 999.9 (°C/°F) (See note.)	Default: 3.0 (°C/°F)
		Controllers with Analog Inputs	0.00 to 99.99 (%FS)	Default: 0.20% FS

Note Set “none” as the unit for analog inputs.

- A loop break alarm can be output by setting the alarm 1 type to 12 (LBA).
- The ALM1 indicator will light when a loop break is detected.
- Loop breaks are not detected during SP ramp operation.
- Loop breaks are not detected during auto-tuning, manual operation, or while stopped.
- If the alarm 1 latch is set to ON, the latch will be effective for the loop break alarm.

Automatically Setting the LBA Detection Time

- The LBA detection time is automatically set by auto-tuning. (It is not set automatically, however, for heating/cooling control.)
- If the optimum LBA detection time is not obtained by auto-tuning, set the “LBA detection time” parameter (advance function setting level).

Determining the LBA Detection Time

1,2,3...

- 1. Set the output to the maximum value.
- 2. Measure the time required for the width of change in the input to reach the LBA band.

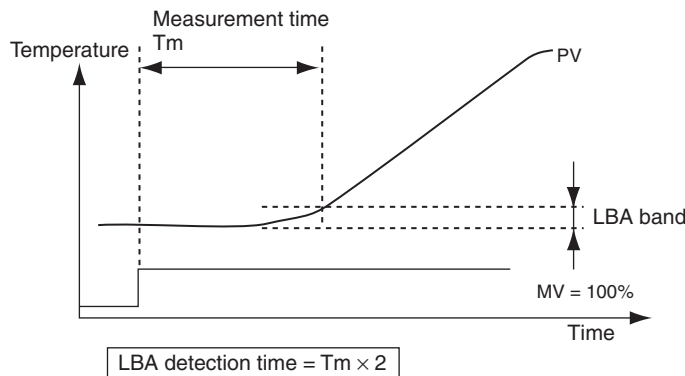

- Set the “LBA detection time” parameter to two times the measured time.

LBA Level

- Set the control deviation when the control loop is working properly.
- The default is 8.0 (°C/°F) for Controllers with Thermocouple/Resistance Thermometer Multi-Inputs and 10.00% FS for Controllers with Analog Inputs.

LBA Band

- There is assumed to be an error in the control loop if the control deviation is greater than the threshold set in the “LBA level” parameter and if the control deviation does not change by at least the value set in the “LBA band” parameter.
- The default is 3.0 (°C/°F) for Controllers with Thermocouple/Resistance Thermometer Multi-Inputs and 0.20% FS for Controllers with Analog Inputs.

Operating Procedure

Perform the following procedure to use the loop break alarm.

In this example, the LBA detection time is set to 10, the LBA level is set to 8.0, and the LBA band is set to 3.0.

Operation Level



Initial Setting Level

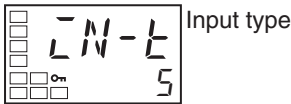

- Press the key for at least three seconds to move from the operation level to the initial setting level.

Initial Setting Level

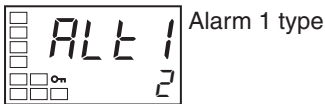

- Select the “alarm 1 type” parameter by pressing the key.

Initial Setting Level

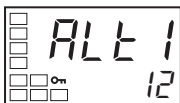

- Press the key to set the parameter to 12.



- Select the “move to advanced function setting level” parameter by pressing the key.

Advanced Function Setting Level

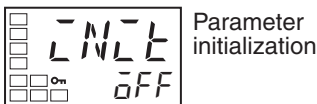

- Press the key to enter the password (-169), and move from the initial setting level to the advanced function setting level.

Advanced Function Setting Level



- Select the “LBA detection time” parameter by pressing the key.

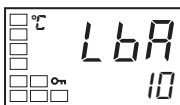

7. Press the key to set the parameter to 10.

Advanced Function Setting Level

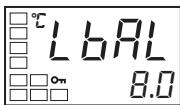

LBA level

8. Select the "LBA level" parameter by pressing the key.

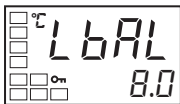

9. Press the key to set the parameter to 8.0. (The default is 8.0.)

Advanced Function Setting Level

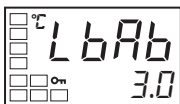

LBA band

10. Select the "LBA band" parameter by pressing the key.

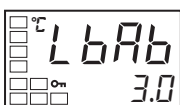

11. Press the or key to set the parameter to 3.0. (The default is 3.0.)

Initial Setting Level

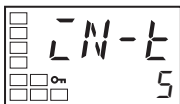

Input type

12. Press the key for at least one second to move from the advanced function setting level to the initial setting level.

Operation Level

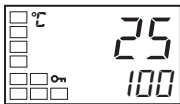

PV/SP

13. Press the key for at least one second to move from the initial setting level to the operation level.

4-13 Performing Manual Control

4-13-1 Manual Operation

- The manipulated variable can be set in manual mode if the "PV/MV" parameter is displayed in the manual control level. The final MV used in automatic mode will be used as the initial manual MV when moving from automatic mode to manual mode. In manual mode, the change value will be fixed immediately and reflected in the actual MV.
- The automatic display return function will not operate in manual mode.
- Balanceless-bumpless operation will be performed for the MV when switching from manual operation to automatic operation. (See note.)
- If a power interruption occurs during manual operation, manual operation will be restarted when power is restored using the same MV as when power was interrupted.
- Switching between automatic and manual operation is possible for a maximum of one million times.
- Manual operation can be used only for PID control.

Note In balanceless-bumpless operation, the MV before switching is used initially after the switch and then gradually changed to achieve the proper value after switch to prevent radical changes in the MV after switching operation.

The overall manual operation is illustrated in the following figure.

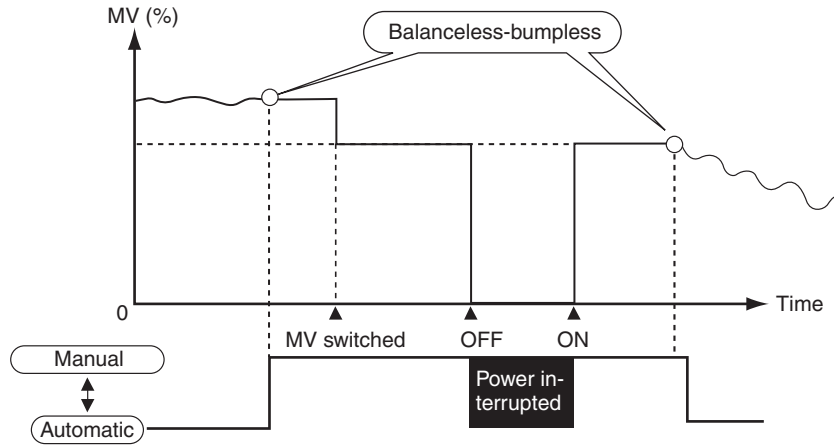



Related Displays and Parameters

Parameter name	Symbol	Level	Remarks
PV/MV (manual MV)	---	Manual Control Level	-5.0 to 105.0 (heating/cooling control: -105.0 to 105.0)
Auto/manual switch	<i>R-M</i>	Operation Level	Switches between automatic and manual modes.
Auto/manual select addition	<i>RMAd</i>	Advanced Function Setting Level	Enables switching between automatic and manual modes.

Note Refer to 4-16 *Output Adjustment Functions* for information on the priority for the MV.

Moving to the Manual Control Level

- When the  key is pressed for at least 3 seconds in the operation level's auto/manual switching display, the manual mode will be entered and the manual control level will be displayed. It is not possible to move to any displays except for the "PV/MV" parameter during manual operation. Press the  key for at least one second from the "PV/MV" display in manual control level to return to automatic mode and display the top parameter in the operation level.

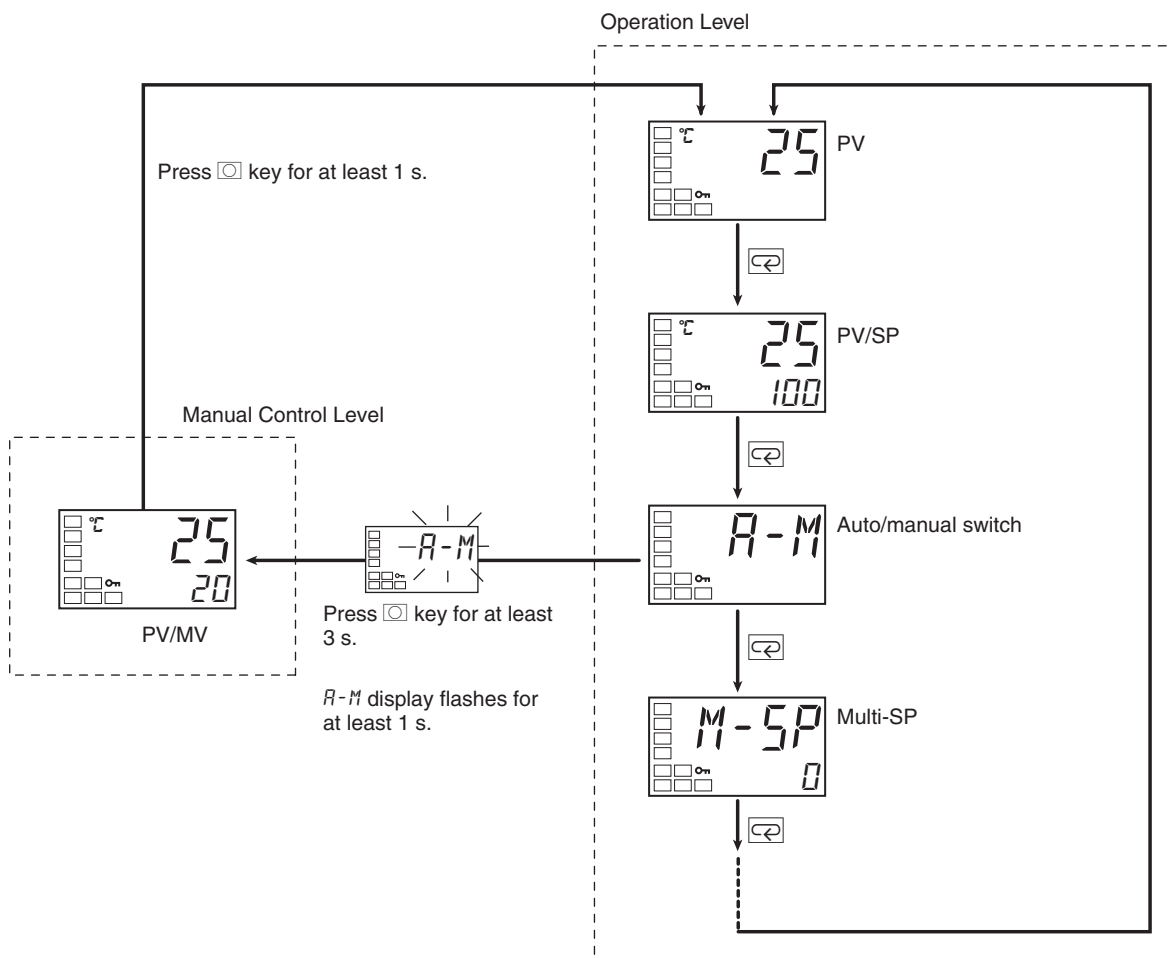

- If an event input is set to “MANU” (auto/manual), the “auto/manual switch” parameter will not be displayed. Use the event input to switch between automatic and manual modes.
- The “auto/manual select addition” parameter must be set to ON in the advance function setting level before it is possible to move to manual mode. The default is OFF.

Auto/Manual Select Addition

Note

- (1) Priority of Manual MV and Other Functions
Even when operation is stopped, the manual MV is given priority. Auto-tuning and self-tuning will stop when manual mode is entered.
- (2) Manual MV and SP Ramp
If operating, the SP ramp function will continue even when manual mode is entered.

Operating Procedure

Use the following procedure to set the manipulated variable in manual mode.

Operation Level



Initial Setting Level

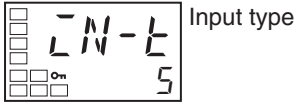

Initial Setting Level

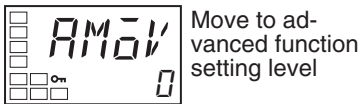

Advanced Function Setting Level

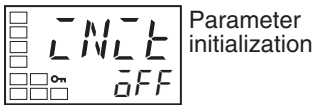

Advanced Function Setting Level



Initial Setting Level

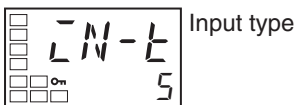

Operation Level

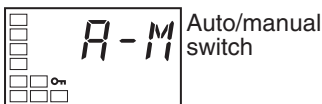

Manual Control Level



1. Press the key for at least three seconds to move from the operation level to the initial setting level.
2. Select the “PID ON/OFF” parameter by pressing the key.
3. Select the “move to advanced function setting level” parameter by pressing the key.
4. Press the key to enter the password (–169), and move from the initial setting level to the advanced function setting level.
5. Select the “auto/manual select addition” parameter by pressing the key.
6. Use the key to set the parameter to ON.
7. Press the key for at least one second to move from the advanced function setting level to the initial setting level.
8. Press the key for at least one second to move from the initial setting level to the operation level.
9. Select the “auto/manual switch” parameter by pressing the key.
10. Press the key for at least three seconds to move from the operation level to the manual control level.

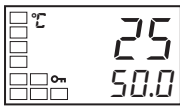

11. Press the or key to set the manual MV. (In this example, the MV is set to 500%.)

Note The manual MV setting must be fixed (see page 12), but values changed with key operations are reflected in the control output immediately.

Operation Level



12. Press the key for at least one second to move from the manual control level to the operation level.

4-14 Using the Transfer Output

4-14-1 Transfer Output Function

- If a control output is a linear current output it can be used as a transfer output. To use the transfer output, set the “transfer output type” parameter to any setting other than OFF.
(When the “transfer output type” parameter is set to any setting other than OFF, the “transfer output upper limit” and “transfer output lower limit” parameters will be enabled.)

Transfer Output Type

Transfer output type	Symbol	Setting range
OFF (See note 1.)	OFF	---
Set point	SP	SP lower limit to SP upper limit
Set point during SP ramp	SP-M	SP lower limit to SP upper limit
PV	PV	Sensor setting range lower limit to Sensor setting range upper limit or Scaling lower limit to Scaling upper limit
MV monitor (heating)	MV	-5.0 to 105.0 (heating/cooling control: 0.0 to 105.0) (See note 2.)
MV monitor (cooling)	[-MV	0.0 to 105.0 (See note 2.)

- Note**
- (1) The default is OFF. If the transfer type is set to OFF, the item assigned in the “control output 1 assignment” parameter will be output on control output 1.
 - (2) The difference between the transfer output value and the linear current output value is illustrated in the following figure.
If the linear output is used as the transfer output when the linear current output type is set to 4 to 20 mA, 4.0 mA will be output for 0% and 20.0 mA will be output for 100%.
When a linear output is used for the control output, 3.7 mA is output for 0% and 20.3 mA is output for 100% when the control output for heating is selected to ensure that the control object is controlled at 0% and 100%.

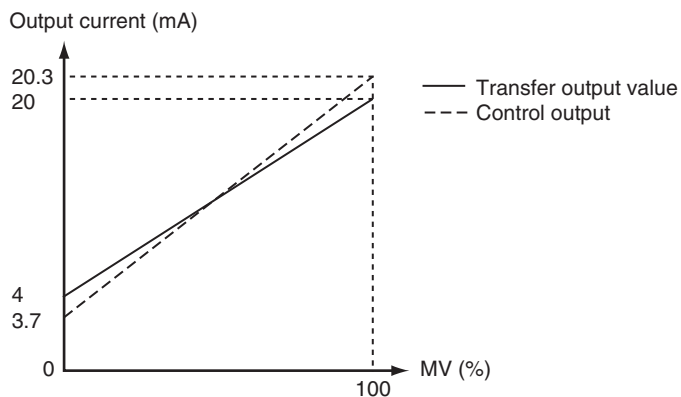

(The above graph is for when the linear current output type is set to 4 to 20 mA.)

Transfer Scaling

- Reverse scaling is possible by setting the “transfer output lower limit” parameter larger than the “transfer output upper limit” parameter. If the “transfer output lower limit” and “transfer output upper limit” parameters are set to the same value when 4 to 20 mA is set, the transfer output will be output continuously at 0% (4 mA).
- If the SP, SP during SP ramp, or PV is selected, the “transfer output lower limit” and “transfer output upper limit” parameters will be forcibly initialized to the respective upper and lower setting limits for changes in the upper and lower limits of the SP limiter and the temperature unit. If the MV for heating or MV for cooling is selected, the “transfer output lower limit” and “transfer output upper limit” parameters will be initialized to 100.0 and 0.0, respectively, when a switch is made between standard control and heating/cooling control using the “standard or heating/cooling” parameter.
- The output current when the linear current type is set to 4 to 20 mA, the transfer output upper limit is set to 90.0, and the transfer output lower limit is set to 10.0 is shown in the following graph.
- For scaling from 0.0% to 100.0%, the output for -5.0 to 0.0 will be the same value as for 0.0%, and the output for 100.0 to 105.0 will be the same value as for 100.0%

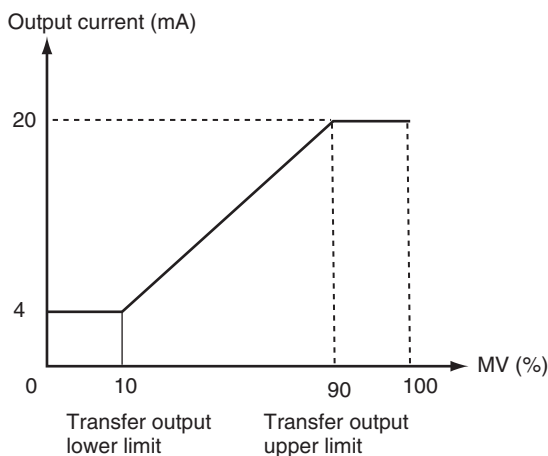

(The above graph is for when the linear current output type is set to 4 to 20 mA.)

Operating Procedure

The following procedure sets the transfer output for an SP range of -50 to 200.

Operation Level



Initial Setting Level

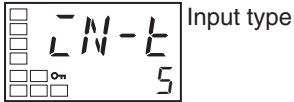

Initial Setting Level

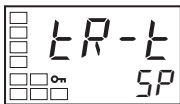
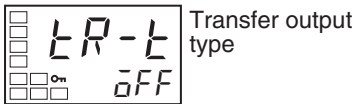

Initial Setting Level

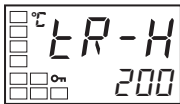

Initial Setting Level

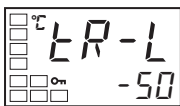
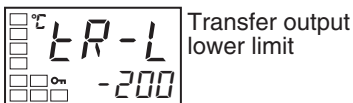

Operation Level



1. Press the key for at least three seconds to move from the operation level to the initial setting level.
2. Select the “transfer output type” parameter by pressing the key.
3. Press the key to select SP (set point).
4. Select the “transfer output upper limit” parameter by pressing the key.
5. Use the key to set the parameter to 200. The default is 1300.
6. Select the “transfer output lower limit” parameter by pressing the key.
7. Use the key to set the parameter to -50. The default is -200.
8. To return to the operation level, press the key for at least one second.

4-15 Using the Simple Program Function

4-15-1 Simple Program Function

- The simple program function can be used for the following type of control.

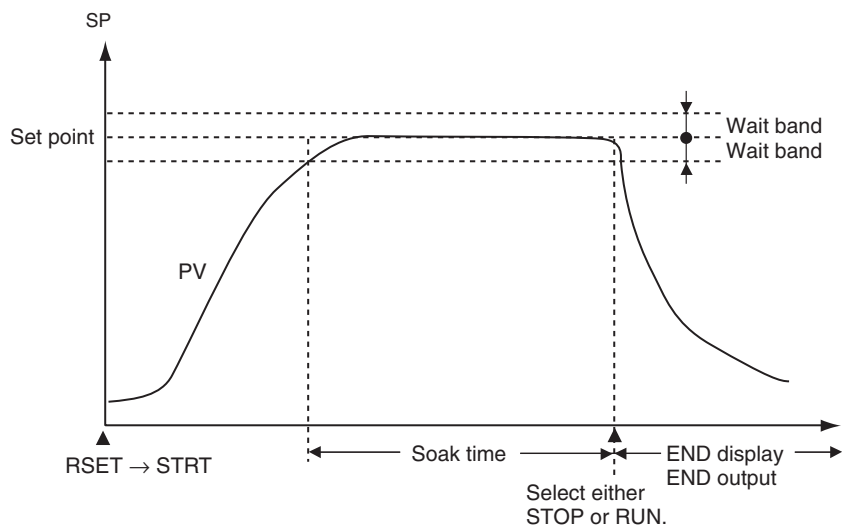

- The program will start when the “program start” parameter is changed from RSET to STRT. END will be displayed on the No. 2 display and the output assigned as the program end output will turn ON after the time set in the “soak time” parameter has expired in the wait band. The “program pattern” parameter can be used to select moving to STOP mode or continuing operation in RUN mode after the program ends.

Parameters Related to the Simple Program Function

Parameter name	Symbol	Set (monitor) values	Unit	Display level
Program pattern	<i>PERN</i>	OFF, STOP, CONT	---	Initial setting level
Program start	<i>PRST</i>	RSET, STRT	---	Operation level
Soak time	<i>SOAK</i>	1 to 9999	min or h	Adjustment level
Soak time unit	<i>t-U</i>	m (minutes)/h (hours)	---	Advanced function setting level
Wait band	<i>Wt-b</i>	OFF or 0.1 to 999.9 (See note 2.)	°C or °F (See notes 1 and 2.)	Adjustment level
Soak time remain monitor	<i>SKLR</i>	0 to 9999	min or h	Operation level

- Note**
- (1) Set for Controllers with Thermocouple/Resistance Thermometer Multi-inputs. Set “none” as the unit for Controllers with Analog Inputs.
 - (2) The setting unit of the “wait band” parameter is %FS for Controllers with Analog Inputs and the setting range is OFF or 0.01 to 99.99.

Program Pattern

Either of two program patterns can be selected. The simple program operation will not be performed if the “program pattern” parameter is set to OFF.

■ **Pattern 1 (STOP)**

Control will stop and the STOP mode will be entered when the program has ended.

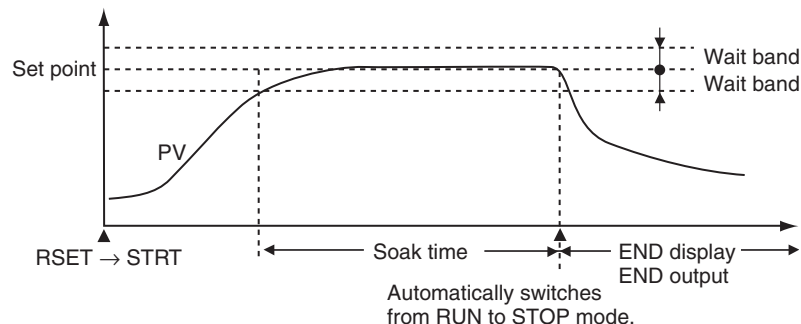

■ **Pattern 2 (CONT)**

Control will continue in RUN mode when the program has ended.

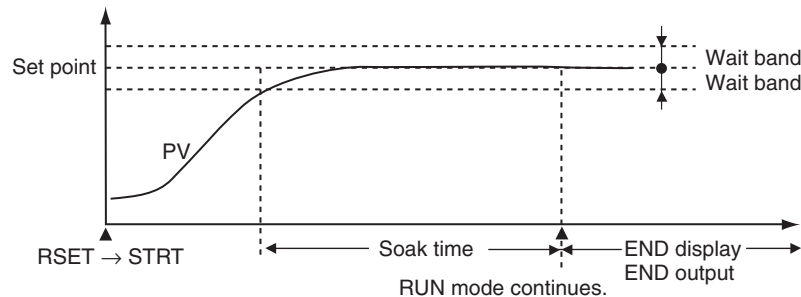

The pattern display and setting range will change as shown in the following table when a program mode is set in the “program pattern” parameter.

Item	Program mode not selected	Program mode selected
Displayed parameters	There are no parameters that are not displayed if a program mode is set.	<ul style="list-style-type: none"> • Program start • Soak time • Soak time unit • Wait band • Soak time remain
Control output 1/2 assignment Alarm 1/2/3 assignment Setting range	Not assigned. Control output (heating) Control output (cooling) Alarm 1 Alarm 2 Alarm 3	Not assigned. Control output (heating) Control output (cooling) Alarm 1 Alarm 2 Alarm 3 Program end output
Event input assignment 1/2 setting range	Not assigned. RUN/STOP AUTO/MANUAL	Not assigned. RUN/STOP AUTO/MANUAL Program start (RESET/START)

Starting Method

Any of the following three methods can be used to start the simple program.

- Setting the “program start” parameter to STRT.
- Turning ON an event input. (The program start must be assigned to an event input. See note.)
- Starting with an Operation Command using communications. (When the program start is not assigned to an event input.)

Note When an event input is used to start and reset the simple program, writing is performed to EEPROM. Be sure to consider the write life (1 million writes) of the EEPROM in the system design. When the program start is assigned to an event input, the “program start” parameter will function as a monitor display, and the RSET/STRT displays can be used to check when the event input has started or reset the simple program. When this is done, the “program start” parameter functions as a monitor display only and cannot be changed using key operations. If the “program pattern” parameter is set to OFF, the event input assignment setting will be initialized to “none.”

Soak Time and Wait Band

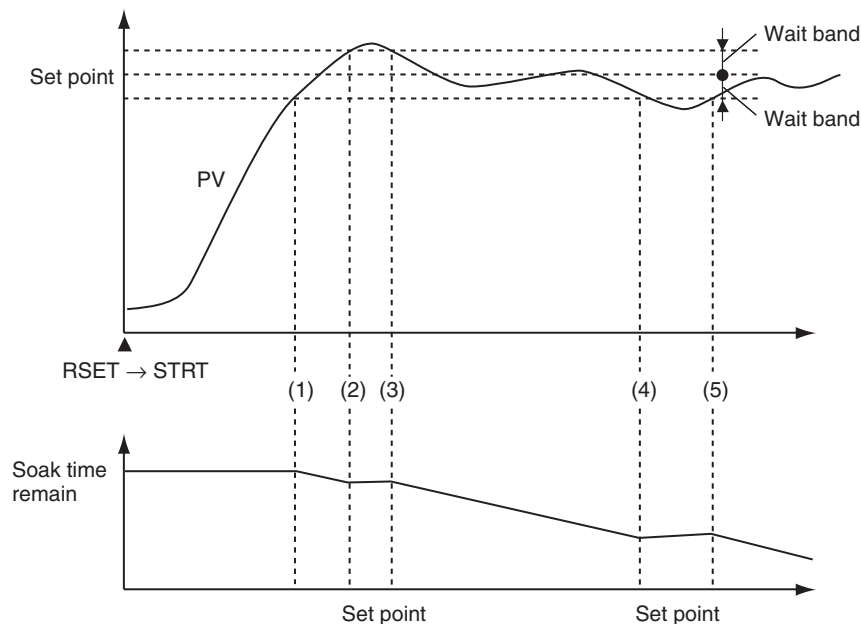

The wait band is the fixed band within which the process value is stable in respect to the set point. The soak time is measured within the wait band. The timer that measures the soak time operates only when the process value is within the wait band around the set point (i.e., $SP \pm$ wait band). In the following diagram, the timer will be stopped between the start and (1), (2) and (3), and (4) and (5) and will measure the time only between (1) and (2), (3) and (4), and (5) and the end.

Note If the wait band is set to OFF, the wait band will be treated as infinity and the timer will measure time continuously after changing from RSET to STRT.

4-15-2 Operation at the Program End

Display at the Program End

When the program ends, the process value will be displayed on the No. 1 display (see note) and the set point and “end” will be alternately displayed on the No. 2 display at 0.5 s intervals.

Note One of the following displays: PV/SP, PV only, or PV/MV.

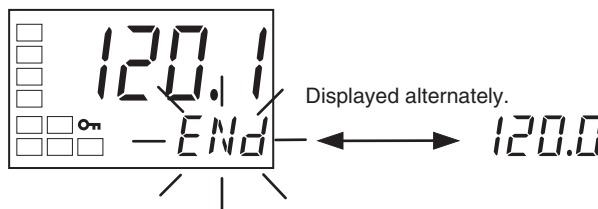

Program End Output

When the “program pattern” parameter is changed from OFF to STOP or CONT, the “alarm 1 output assignment” parameter will automatically be set to the END output. The ALM1 indicator will not light while the END output is set. (When the “program pattern” parameter is changed from STOP or CONT to OFF, the “alarm 1 output assignment” parameter will automatically be initialized to ALM1.) The output assignment parameters can also be used to assign the program END output to any output.

The program END output is also provided in communications status.

Clearing the Program End Status

The program END output and display will be cleared when the “program start” parameter is changed from STRT to RSET. The setting is changed from STRT to RSET while the “program start” parameter is displayed.

The program END status can also be cleared using an event. If the program start function is assigned to an event, however, the program end status cannot be cleared from the “program start” parameter display, which will function only as a monitor display.

Operating Procedure

Perform the following procedure to use the simple program function.

In this example, the program pattern will be set to STOP, the soak time to 10 min, and the wait band to 3.

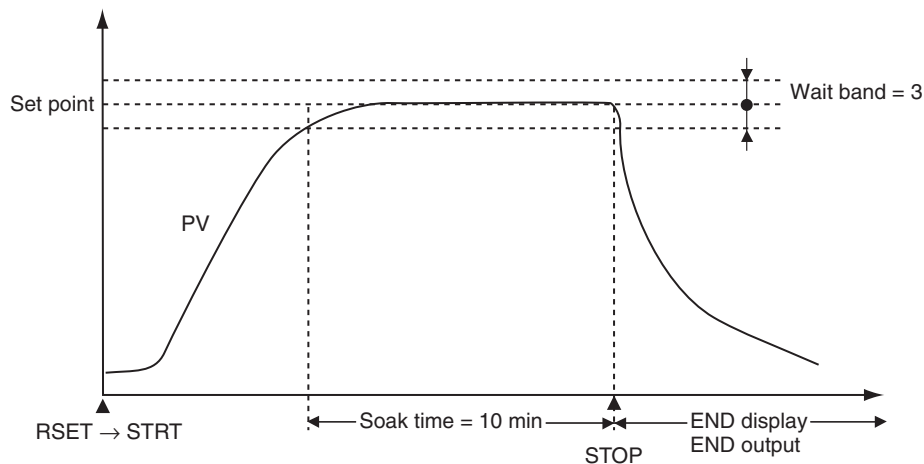

Operation Level



Initial Setting Level

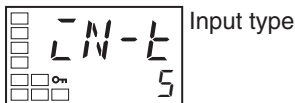

1. Press the key for at least three seconds to move from the operation level to the initial setting level.

Initial Setting Level



2. Select the “program pattern” parameter by pressing the key.

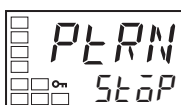

3. Use the key to set the parameter to STOP.

Operation Level



4. Press the key for at least one second to move from the initial setting level to the operation level.

Adjustment Level



5. Press the key to move from the operation level to the adjustment level.

Adjustment Level

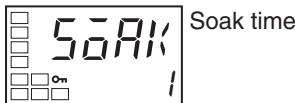

6. Select the “soak time” parameter by pressing the key.



7. Use the key to set the parameter to 10. (The soak time unit is set in “soak time unit” parameter in the advance function setting level. The default is M (minutes).

Adjustment Level

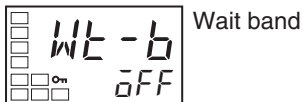

8. Select the “wait band” parameter by pressing the key.

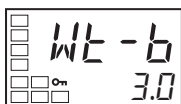

9. Use the key to set the parameter to 3.0.

Operation Level



10. Press the key to move from the adjustment level to the operation level.

4-15-3 Application Example Using a Simple Program

The program will be started by changing the setting of the “program start” parameter. The following example shows using a simple program with the program pattern set to STOP.

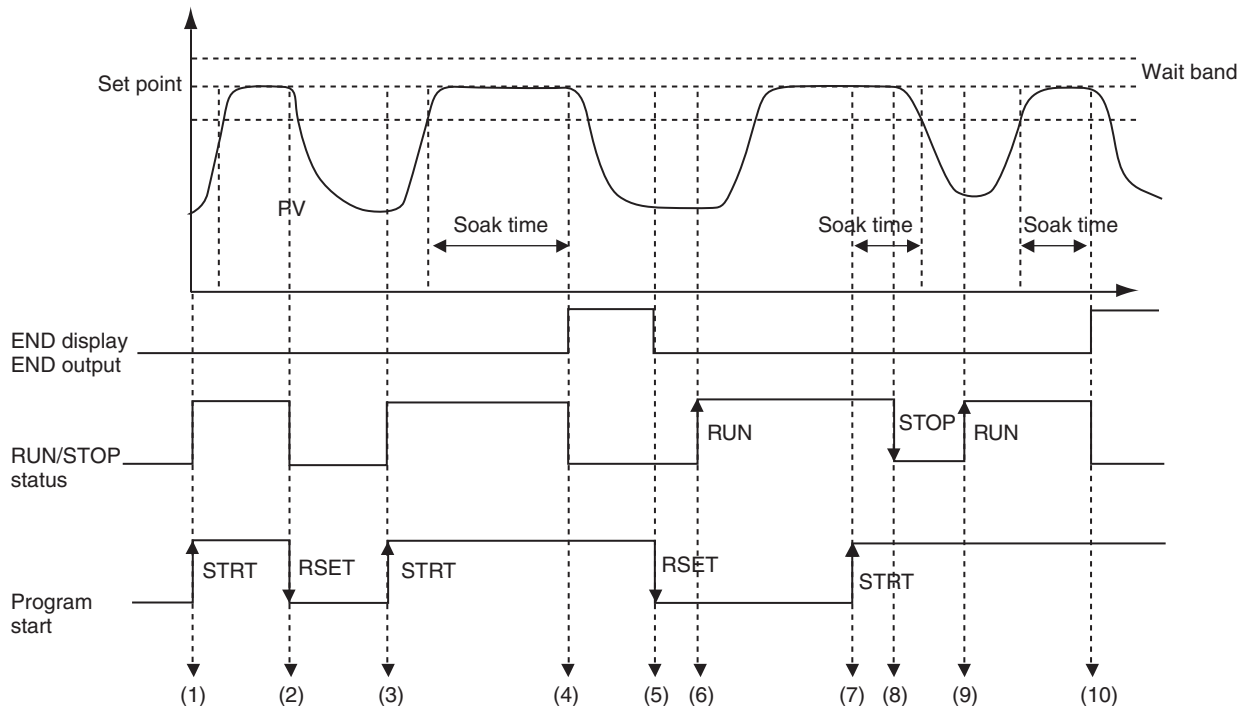

Timing	Description
(1)	<ul style="list-style-type: none"> The “program start” parameter was changed from RSET to STRT using either an event or key operations. The RUN/STOP status automatically changes to RUN mode when the above operation is performed.
(2)	<ul style="list-style-type: none"> The “program start” parameter was changed from STRT to RSET using either an event or key operations before the soak time expires. The RUN/STOP status automatically changes to STOP mode when the above operation is performed.
(3)	<ul style="list-style-type: none"> The “program start” parameter is again changed from RSET to STRT using either an event or key operations. The RUN/STOP status will automatically change to RUN mode when the above operation is performed.
(4)	<ul style="list-style-type: none"> The RUN/STOP status automatically changes to STOP mode when soak time expires. END flashes on the No. 2 display and the program END output turns ON.
(5)	<ul style="list-style-type: none"> The “program start” parameter is changed from STRT to RSET using either an event or key operations. The END display is cleared and the program END output turns OFF.
(6)	<ul style="list-style-type: none"> Key operations are used to switch the RUN/STOP status to RUN with the “program start” parameter set to RSET (stopped). Normal control operation is started.
(7)	<ul style="list-style-type: none"> The “program start” parameter is changed from RSET to STRT after the process value stabilizes. The RUN/STOP status remains as RUN.
(8)	<ul style="list-style-type: none"> Key operations are used to change the RUN/STOP status to STOP (during program operation). Measuring the soak time is continued within the wait band. (Measuring the soak time stops when the process value leaves the wait band.)
(9)	<ul style="list-style-type: none"> Key operations are used to change the RUN/STOP status to RUN. Measuring the soak time is continued within the wait band (continuing from the time between (7) and (9)).
(10)	<ul style="list-style-type: none"> The RUN/STOP status automatically changes to STOP mode when the measured time reaches the soak time. END flashes on the No. 2 display and the program END output turns ON.

4-16 Output Adjustment Functions

4-16-1 Output Limits

- Output limits can be set to control the output using the upper and lower limits to the calculated MV.
- The following MV takes priority over the MV limits.
 Manual MV
 MV at stop
 MV at PV error

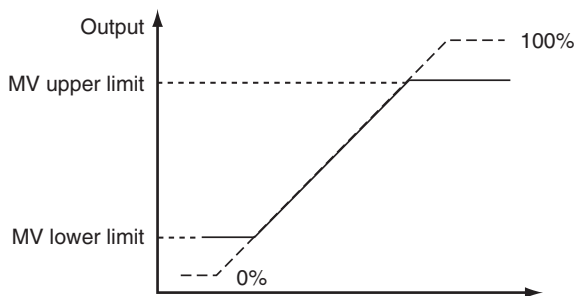

- For heating/cooling control, upper and lower limits are set of overall heating/cooling control. (They cannot be set separately for heating/cooling.)

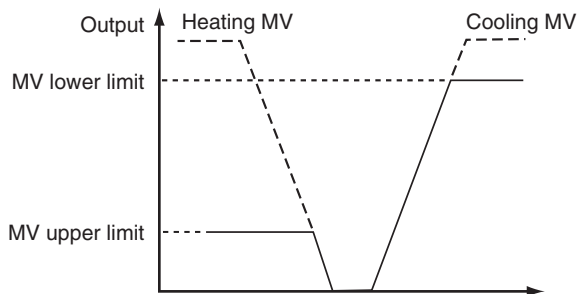

4-16-2 MV at Stop

- The MV when control is stopped can be set.
 For heating/cooling control, the MV at stop will apply to the cooling side if the MV is negative and to the heating side if the MV is positive.
 The default is 0.0, so an MV will not be output for either standard or heating/cooling control.

Parameter	Setting range	Unit	Default
MV at stop	-5.0 to 105.0 for standard control -105.0 to 105.0 (heating/cooling control)	%	0.00

Note The order of priority is as follows: Manual MV > MV at stop > MV at PV error.

4-16-3 MV at PV Error

- The MV to be output for input errors or heater burnout errors can be set. The MV at stop takes priority when stopped and the manual MV takes priority in manual mode.

Parameter	Setting range	Unit	Default
MV at PV error	-5.0 to 105.0 for standard control -105.0 to 105.0 (heating/cooling control)	%	0.0

Note The order of priority is as follows: Manual MV > MV at stop > MV at PV error.

- The order of priority of the MVs is illustrated in the following diagram.

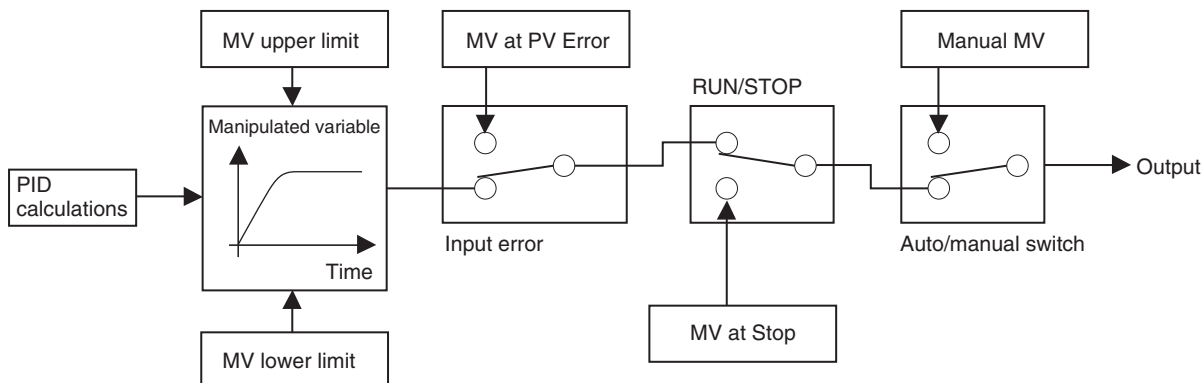

SECTION 5

Parameters

This section describes the individual parameters used to setup, control, and monitor operation.

5-1	Conventions Used in this Section	114
5-1-1	Meanings of Icons Used in this Section	114
5-1-2	About Related Parameter Displays	114
5-1-3	About the Order in Which Parameters Are Described in This Section	114
5-2	Protect Level	115
5-3	Operation Level.	118
5-4	Adjustment Level	129
5-5	Manual Control Level	144
5-6	Initial Setting Level	145
5-7	Advanced Function Setting Level	157
5-8	Communications Setting Level	182

5-1 Conventions Used in this Section

5-1-1 Meanings of Icons Used in this Section



Function

Describes the functions of the parameter.



Setting

Describes the setting range and default of the parameter.



Monitor

Used to indicate parameters used only for monitoring.



Operation

Describes the parameter settings, such as those for Operation Commands, and procedures.



Used to indicate information on descriptions in which the parameter is used or the names of related parameters.

5-1-2 About Related Parameter Displays

Parameters are displayed only when the conditions for use given on the right of the parameter heading are satisfied. Protected parameters are not displayed regardless of the conditions for use, but the settings of these parameters are still valid.



5-1-3 About the Order in Which Parameters Are Described in This Section

Parameters are described level by level. The first page of each level describes the parameters in the level and the procedure to switch between parameters.

5-2 Protect Level

Three levels of protection are provided on the E5CN, operation/adjustment protect, initial setting/communications protect, and setting change protect. These protect levels prevent unwanted operation of the keys on the front panel in varying degrees.

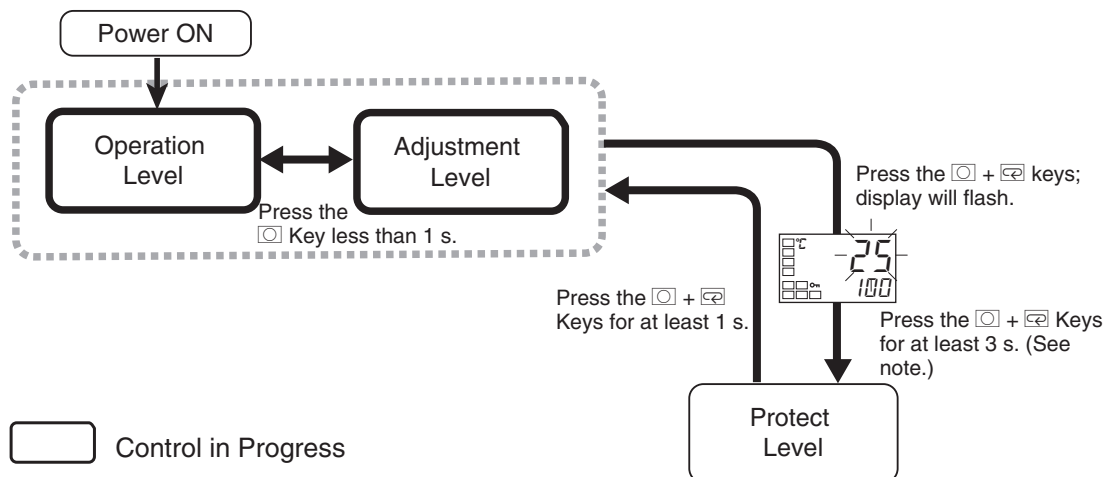

To move from the operation level to the protect level, press \square and \square keys for three seconds (see note) or more.

Note The time taken to move to the protect level can be adjusted by changing the “Move to protect level time” parameter setting.

Protect Level		Page
\square \square \square \square PMOV	Move to protect level Displayed only when a password is set.	115
\square \square \square \square OAPL	Operation/adjustment protect	116
\square \square \square \square CCP	Initial setting/communications protect	116
\square \square \square \square WLP	Setting change protect	116
\square \square \square \square PMS	Parameter mask enable	117
\square \square \square \square PRL	Password to move to protect level	117

Parameters that are protected will not be displayed and their settings cannot be changed.

PM0V

Move to Protect Level

The “password to move to protect level” password must not be set to 0.



Function

The password to move to the protect level is entered for this parameter.

- The password to move to the protect level (i.e., the password set for the “password to move to protect level” parameter) is entered for this parameter.
- The “operation/adjustment protect” parameter will be displayed if the correct password is entered.



See

■ **Related Parameters**

Password to move to protect level (protect level): Page 117

0RPL

Operation/Adjustment Protect

1LPL

Initial Setting/Communications Protect

WtPL

Setting Change Protect

These parameters specify the range of parameters to be protected. Shaded settings indicate the defaults.



Function

■ **Operation/Adjustment Protect**

The following table shows the relationship between set values and the range of protection.

Level		Set value			
		0	1	2	3
Operation Level	PV	Can be displayed	Can be displayed	Can be displayed	Can be displayed
	PV/SP	Can be displayed and changed	Can be displayed and changed	Can be displayed and changed	Can be displayed
	Others	Can be displayed and changed	Can be displayed and changed	Cannot be displayed and moving to other levels is not possible	Cannot be displayed and moving to other levels is not possible
Adjustment Level		Can be displayed and changed	Cannot be displayed and moving to other levels is not possible	Cannot be displayed and moving to other levels is not possible	Cannot be displayed and moving to other levels is not possible

- Parameters are not protected when the set value is set to 0.

■ **Initial Setting/Communications Protect**

This protect level restricts movement to the initial setting level, communications setting level, and advanced function setting level.

Set value	Initial setting level	Communications setting level	Advanced function setting level
0	Movement possible	Movement possible	Movement possible
1	Movement possible	Movement possible	Movement not possible
2	Movement not possible	Movement not possible	Movement not possible

■ Setting Change Protect

Changes to settings using key operations are restricted.

Set value	Description
OFF	Settings can be changed using key operations.
ON	Settings cannot be changed using key operations. (The protect level settings, however, can be changed.)

- The all protect indication () will light when setting is ON.

PMSK

Parameter Mask Enable

This parameter is displayed only when a parameter mask has been set from the Setup Tool.



Function



Setting

- This parameter turns the parameter mask function ON and OFF.





Setting range	Default
$\bar{0}N$: Enabled, $\bar{0}FF$: Disabled	$\bar{0}N$

Note A parameter mask can be used to hide the displays of parameters that are not needed. The parameter mask function is provided by the Setup Tool.
Setup Tool: EST2

PRLP

Password to Move to Protect Level

This parameter is used to set the password to move to the protect level.

- To prevent setting the password incorrectly, the  and  keys or  and  keys must be pressed simultaneously to set the password.



Function



Setting

Setting range	Default
-1999 to 9999	0

- Set this parameter to 0 when no password is to be set.

■ Related Parameters

Move to protect level (protect level): Page 116

Note Protection cannot be cleared or changed without the password. Be careful not to forget it. If you forget the password, contact your OMRON sales representative.



5-3 Operation Level

Display this level to perform control operations on the E5CN. You can set alarm values, monitor the manipulated variable, and perform other operations in this level.

In the advanced function setting level, you can set a parameter to hide or show the set points.

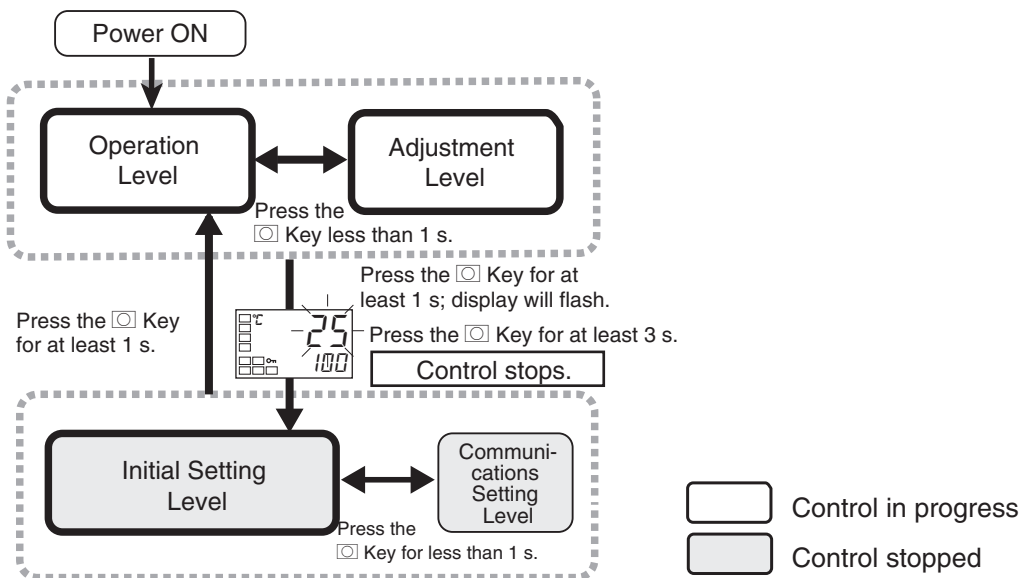

This level is displayed immediately after the power is turned ON.

To move to other levels, press the \square key or the \square and \square keys.

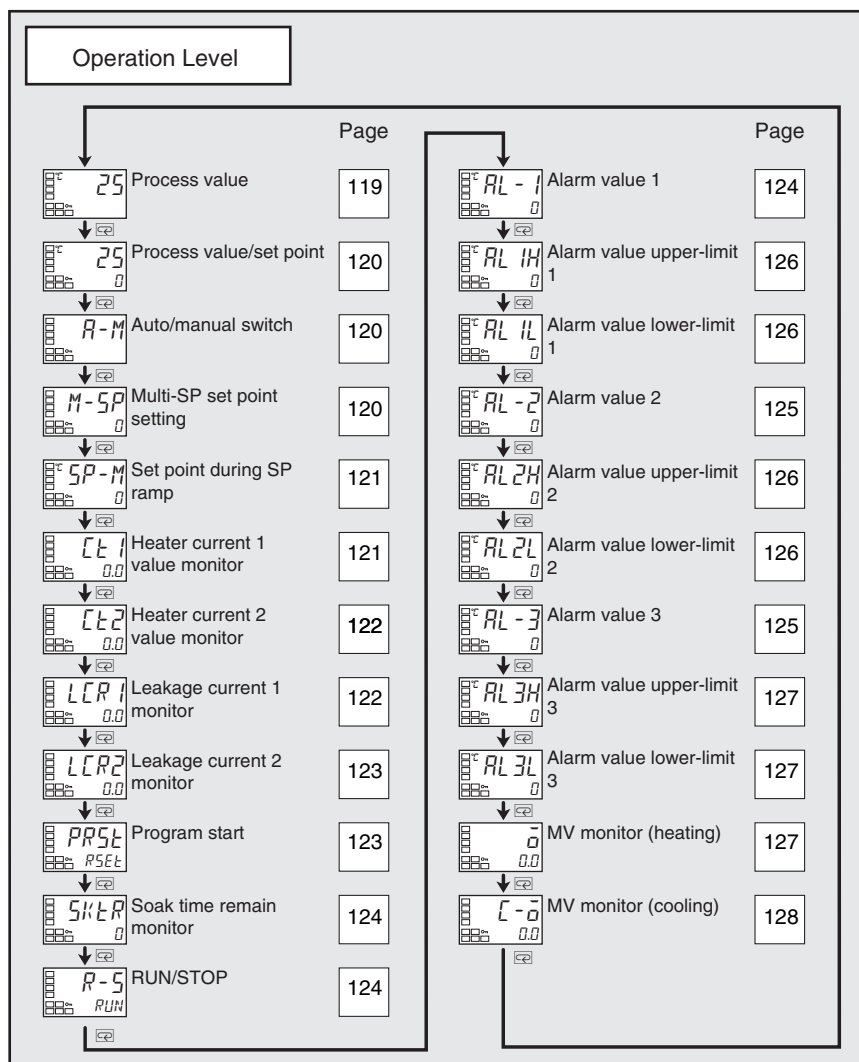

Process Value

The “additional PV display” parameter must be set to ON.



Function



Monitor

The process value is displayed on the No. 1 display, and nothing is displayed (blank) on the No. 2 display.

	Monitor range	Unit
Process value	Input indication range (See page 219.)	EU

During temperature input, the decimal point position depends on the currently selected sensor, and during analog input it depends on the “decimal point” parameter setting.

■ Related Parameters

Input type: Page 146, Set point upper limit, Set point lower limit: Page 149 (initial setting level)



Process Value/Set Point



Function

The process value is displayed on the No. 1 display, and the set point is displayed on the No. 2 display.

	Monitor range	Unit
Process value	Input indication range (See page 219.)	EU

	Setting range	Unit
Set point	SP lower limit to SP upper limit	EU

During temperature input, the decimal point position depends on the currently selected sensor, and during analog input it depends on the “decimal point” parameter setting.

Refer to the “process value” parameter.



R-M

Auto/Manual Switch

The “event input assignment 1/2” parameters must not be set to “auto/manual” and the “auto/manual select addition” parameter must be set to ON.
The control must be set to 2-PID control.



Function

- This parameter switches the Controller between automatic and manual modes.
- If the key is pressed for at least 3 seconds when the “auto/manual switch” parameter is displayed, the manual mode will be entered and the manual control level will be displayed.
- This parameter will not be displayed if an event input is set to “MANU” (auto/manual).

■ **Related Parameters**

PID ON/OFF (initial setting level): Page 149

Auto/manual select addition (advance function setting level): Page 173



M-SP

Multi-SP Set Point Setting (Set Points 0 to 3)

The “multi-SP uses” parameter must be set to ON.



Function

To use the multi-SP function, preset the four set points (SP 0 to 3) in the adjustment level, and then switch the set point either by operating the keys or by using external input signals (event inputs).

This parameter is used to select set points 0 to 3.

SP-M

Set Point During SP Ramp

The “SP ramp set value” parameter must not be set to OFF.
The “ST” parameter must be set to OFF.



Function

This parameter monitors the set point during SP ramp operation.
A ramp is used to restrict the change width of the set point as a rate of change.

This parameter is displayed when a set value is input for the “SP ramp set value” (adjustment level).

When not in ramp operation, the set point will be the same as the one displayed for the “process value/set point” parameter.

Monitor range	Unit
SP: SP lower limit to SP upper limit	EU



Monitor



■ **Related Parameters**

Process value/set point (operation level): Page 120

SP ramp set value (adjustment level): Page 143

Set point upper limit, Set point lower limit (initial setting level): Page 149

EH 1

Heater Current 1 Value Monitor

Heater burnout and HS alarms must be supported.
Alarm 1 must be assigned.
The “heater burnout detection” parameter must be set to ON.



Function

This parameter measures the heater current from the CT input used for detecting heater burnout.

This parameter measures and displays the heater current value.

- Heater burnouts are not detected if the control output (heating) ON time is 190 ms or less.

Monitor range	Unit
0.0 to 55.0	A



Monitor

- FFFF is displayed when 55.0 A is exceeded.
- If a heater burnout is detected, the HA indicator will light, and the relative setting level will flash on the No. 1 display.



■ **Related Parameters**

Heater burnout detection 1, Heater burnout detection 2 (adjustment level): Page 134

Heater burnout (advanced function setting level): Page 163

Error Displays EH 1: Page 206

〔 2 〕

Heater Current 2 Value Monitor

Heater burnout and HS alarms must be supported (two CTs). Alarm 1 must be assigned. The “heater burnout detection” parameter must be set to ON.



Function

This parameter measures the heater current from the CT input used for detecting heater burnout.

This parameter measures and displays the heater current value.

- Heater burnouts are not detected if the control output (heating) ON time is 190 ms or less.



Monitor

Monitor range	Unit
0.0 to 55.0	A

- FFFF is displayed when 55.0 A is exceeded.
- If a heater burnout is detected, the HA indicator will light, and the relative setting level will flash on the No. 1 display.



■ **Related Parameters**

Heater burnout detection 1, Heater burnout detection 2 (adjustment level): Page 134

Heater burnout (advanced function setting level): Page 163

Error Displays 〔 2 〕: Page 206

LER 1

Leakage Current 1 Monitor

Heater burnout and HS alarms must be supported. Alarm 1 must be assigned. The “HS alarm use” parameter must be set to ON.



Function

This parameter measures the heater current from the CT input used for detecting SSR short-circuits.

The heater current is measured and the leakage current 1 monitor is displayed.

- HS are not detected if the control output (heating) OFF time is 190 ms or less.



Monitor

Monitor range	Unit
0.0 to 55.0	A

- FFFF is displayed when 55.0 A is exceeded.
- If an SSR short-circuit is detected, the HA indicator will light, and the relative setting level will flash on the No. 1 display.



■ **Related Parameters**

HS alarm 1, HS alarm 2 (adjustment level): Page 135

Failure detection (advanced function setting level): Page 174

Error Displays LER 1: Page 206

LCR2

Leakage Current 2 Monitor

Heater burnout and HS alarms must be supported (two CTs). Alarm 1 must be assigned. The “HS alarm use” parameter must be set to ON.



Function

This parameter measures the heater current from the CT input used for detecting SSR short-circuits.

This parameter measures and displays the heater current value.

- HS are not detected if the control output (heating) OFF time is 190 ms or less.



Monitor

Monitor range	Unit
0.0 to 55.0	A

- FFFF is displayed when 55.0 A is exceeded.
- If an SSR short-circuit is detected, the HA indicator will light, and the relative setting level will flash on the No. 1 display.



■ **Related Parameters**

- Hs alarm 1, HS alarm 2 (adjustment level): Page 135
- HS alarm use (advanced function setting level): Page 174
- Error Displays LCR2: Page 206

PR5L

Program Start

The “program pattern” parameter must not be set to OFF.



Function

This parameter starts and stops the simple program function.

- The RUN/STOP status will automatically switch to RUN when this parameter is set to STRT.
- The simple program will stop when this parameter is set to RSET.
- This parameter will function as a monitor display for the start/stop status of the simple program if an event input is selected to start the simple program.



Operation

Setting range		Default
RSET	Stops the simpler program.	RSET
STRT	Starts the simpler program.	



■ **Related Parameters**

- Soak time remain: Page 124, RUN/STOP: Page 124 (operation level)
- Soak time, Wait band (adjustment level): Page 141
- Program pattern (initial setting level): Page 151
- Soak time unit (advanced function setting level): Page 181

SKTR

Soak Time Remain

The “program pattern” parameter must not be set to OFF.



Function

- This parameter measures and displays the remaining time of the soak time for the simple program function.



Monitor

Monitor range	Unit
0 to 9999	min or h



■ **Related Parameters**

- Program start (operation level): Page 123
- Soak time, Wait band (adjustment level): Page 141
- Program pattern (initial setting level): Page 151
- Soak time unit (advanced function setting level): Page 181

R-5

RUN/STOP

The run/stop function must not be set for the “event input assignment 1/2” parameter.



Function

This parameter starts and stops the control operation.
 When *RUN* (RUN) is selected, control is started. When *STOP* (STOP) is selected, control is stopped. The STOP indicator will light when control.
 The default is *RUN*.



This parameter will not be displayed if an event input is set to “RUN/STOP.”

RL - 1

Alarm Value 1

Alarm 1 must be assigned.
 The “alarm 1 type” parameter must not be set to an upper/lower limit alarm and a loop break alarm must not be set.



Function

This parameter is set to one of the input values “X” in the alarm type list.

- This parameter sets the alarm value for alarm output 1.
- During temperature input, the decimal point position depends on the currently selected sensor, and during analog input it depends on the “decimal point” parameter setting.



Setting

Setting range	Unit	Default
-1999 to 9999	EU	0



■ **Related Parameters**

Input type: Page 146, Scaling upper limit, Scaling lower limit, Decimal point (initial setting level): Page 148 (initial setting level)

Alarm 1 type (initial setting level): Page 152

Standby sequence reset: Page 161, Alarm 1 open in alarm: Page 162, Alarm 1 hysteresis: Page 163, Alarm 1 latch: Page 167 (advanced function setting level)

AL - 2

Alarm Value 2

Alarm 2 must be assigned.
The alarm 2 type must be set to other than an upper and lower limit alarm.



Function

This parameter is set to one of the input values “X” in the alarm type list.

- This parameter sets the alarm value for alarm output 2.
- During temperature input, the decimal point position depends on the currently selected sensor, and during analog input it depends on the “decimal point” parameter setting.



Setting

Setting range	Unit	Default
-1999 to 9999	EU	0



■ **Related Parameters**

Input type: Page 146, Scaling upper limit, Scaling lower limit, Decimal point (initial setting level): Page 148 (initial setting level)

Alarm 2 type (initial setting level): Page 154

Standby sequence reset: Page 161, Alarm 2 open in alarm: Page 162, Alarm 2 hysteresis: Page 163, Alarm 2 latch: Page 167 (advanced function setting level)

AL - 3

Alarm Value 3

Alarm 3 must be assigned.
The alarm 3 type must be set to other than an upper and lower limit alarm.



Function

This parameter is set to one of the input values “X” in the alarm type list.

- This parameter sets the alarm value for alarm output 3.
- During temperature input, the decimal point position depends on the currently selected sensor, and during analog input it depends on the “decimal point” parameter setting.



Setting

Setting range	Unit	Default
-1999 to 9999	EU	0



■ **Related Parameters**

Input type: Page 146, Scaling upper limit, Scaling lower limit, Decimal point (initial setting level): Page 148 (initial setting level)

Alarm 3 type (initial setting level): Page 154

Standby sequence reset: Page 161, Alarm 3 open in alarm: Page 162, Alarm 3 hysteresis: Page 163, Alarm 3 latch: Page 167 (advanced function setting level)

RL 1H

Alarm Value Upper Limit 1

Alarm 1 must be assigned.

Alarm 1 type must be set to upper and lower limits, upper and lower limit range, or upper- and lower-limit with standby sequence.

RL 1L

Alarm Value Lower Limit 1

These parameters independently set the alarm value upper and lower limits when the mode for setting the upper and lower limits is selected for the “alarm 1 type” parameter (initial setting level).

- This parameter sets the upper and lower limit values of alarm 1.
- During temperature input, the decimal point position depends on the currently selected sensor, and during analog input it depends on the “decimal point” parameter setting.



Setting range	Unit	Default
-1999 to 9999	EU	0



■ **Related Parameters**

Input type: Page 146, Scaling upper limit, Scaling lower limit, Decimal point: Page 148, Alarm 1 type: Page 152 (initial setting level), Standby sequence reset: Page 161, Alarm 1 open in alarm: Page 162, Alarm 1 hysteresis: Page 163, Alarm 1 latch: Page 167 (advanced function setting level)

RL 2H

Alarm Value Upper Limit 2

Alarm 2 must be assigned.

Alarm 2 type must be set to upper and lower limits, upper and lower limit range, or upper- and lower-limit alarm with standby sequence.

RL 2L

Alarm Value Lower Limit 2

These parameters independently set the alarm value upper and lower limits when the mode for setting the upper and lower limits is selected for the “alarm 2 type” parameter (initial setting level).

- This parameter sets the upper and lower limit values of alarm 2.
- During temperature input, the decimal point position depends on the currently selected sensor, and during analog input it depends on the “decimal point” parameter setting.



Setting range	Unit	Default
-1999 to 9999	EU	0



■ **Related Parameters**

Input type: Page 146, Scaling upper limit, Scaling lower limit, Decimal point: Page 148, Alarm 2 type: Page 154 (initial setting level), Standby sequence reset: Page 161, Alarm 2 open in alarm: Page 162, Alarm 2 hysteresis: Page 163, Alarm 2 latch: Page 167 (advanced function setting level)

RL 3H

Alarm Value Upper Limit 3

Alarm 3 must be assigned.
Alarm 3 type must be set to upper and lower limits, upper and lower limit range, or upper- and lower-limit alarm with standby sequence.

RL 3L

Alarm Value Lower Limit 3

These parameters independently set the alarm value upper and lower limits when the mode for setting the upper and lower limits is selected for the “alarm 3 type” parameter (initial setting level).



Function

- This parameter sets the upper and lower limit values of alarm 3.
- During temperature input, the decimal point position depends on the currently selected sensor, and during analog input it depends on the “decimal point” parameter setting.



Setting

Setting range	Unit	Default
-1999 to 9999	EU	0

■ **Related Parameters**



Input type: Page 146, Scaling upper limit, Scaling lower limit, Decimal point: Page 148, Alarm 3 type: Page 154 (initial setting level), Standby sequence reset: Page 161, Alarm 3 open in alarm: Page 162, Alarm 3 hysteresis: Page 163, Alarm 3 latch: Page 167 (advanced function setting level)

ā

MV Monitor (Heating)

The “MV display” parameter must be set to ON.

This parameter is used to check the manipulated variable for the heating control output during operation.



Function

- This parameter cannot be set.
- During standard control, the manipulated variable is monitored. During heating/cooling control, the manipulated variables on the heating control output is monitored.
- The default is OFF and the manipulated variable is not displayed.



Monitor

Control	Monitor range	Unit
Standard	-5.0 to 105.0	%
Heating/cooling	0.0 to 105.0	%

■ **Related Parameters**



MV display (advanced function setting level): Page 166

[- \bar{a}]

MV Monitor (Cooling)

The control system must be set to heating/cooling control.
The "MV display" parameter must be set to ON.



Function



Monitor



This parameter is used to check the manipulated variable for the cooling control output during operation.

- This parameter cannot be set.
- During heating/cooling control, the manipulated variable on the cooling control output is monitored.
- The default is OFF and the manipulated variable is not displayed.

Control	Monitor range	Unit
Heating/cooling	0.0 to 105.0	%

■ **Related Parameters**

Standard or heating/cooling (initial setting level): Page 150

MV display (advanced function setting level): Page 166

5-4 Adjustment Level





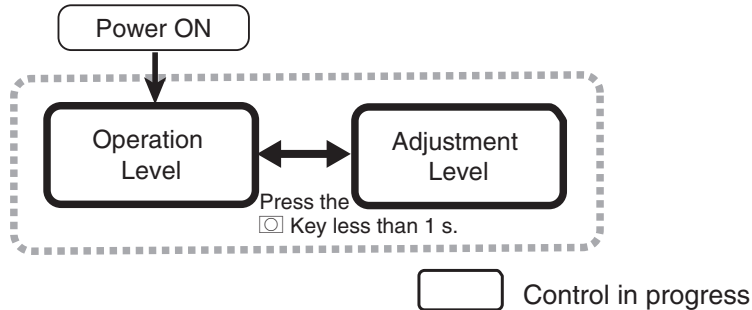



























This level is for executing AT (auto-tuning) and other operations, and for set control parameters.

This level provides the basic Controller parameters for PID control (proportional band, integral time, derivative time) and heating/cooling control.



To move to the adjustment level from the operation level, press the key once.

- The set points 0 to 3 in the adjustment level are the set values for switching the set point during multi-SP input.
- The following parameters are displayed for Controllers with CT Inputs: Heater current monitors, Leakage current monitors, heater burnout detections, and HS alarms.
- Adjustment level parameters can be changed after setting the "operation/adjustment protect" parameter to 0. Displays and changing levels are not possible if the "operation/adjustment protect" parameter is set to 1 to 3. Protection is set in the protect level.

Adjustment Level		Page	Page	Page	
 Adjustment level display	130	 SP 0	136	 Dead band	139
 AT execute/cancel	131	 SP 1	136	 Manual reset value	140
 Communications writing	131	 SP 2	136	 Hysteresis (heating)	140
 Heater current 1 value monitor	132	 SP 3	136	 Hysteresis (cooling)	140
 Heater current 2 value monitor	132	 Temperature input shift	136	 Soak time	141
 Leakage current 1 monitor	133	 Upper-limit temperature input shift value	137	 Wait band	141
 Leakage current 2 monitor	133	 Lower-limit temperature input shift value	137	 MV at stop	142
 Heater burnout detection 1	134	 Proportional band	138	 MV at PV error	142
 Heater burnout detection 2	134	 Integral time	138	 SP ramp set value	143
 HS alarm 1	135	 Derivative time	138	 MV upper limit	143
 HS alarm 2	135	 Cooling coefficient	139	 MV lower limit	143

L.RdJ Adjustment Level Display



Function

This parameter is displayed after moving to the adjustment level.

- This parameter indicates that the adjustment level has been entered. (The “adjustment level” parameter will not be displayed again even if the  key is pressed in the adjustment level to scroll through the parameters.)

Rt

AT Execute/Cancel

The E5CN must be in operation, and control must be 2-PID control.



Function



Operation

This parameter executes auto-tuning (AT).

- The MV is forcibly increased and decreased around the set point to find the characteristics of the control object. From the results, the PID constants are automatically set in the “proportional band” (P), “integral time” (I), and “derivative time” (D) parameters.
- This parameter is normally \bar{OFF} . If you press the  key, the parameter is turned ON and AT is executed. AT cannot be executed when control is stopped or during ON/OFF control.
- When AT execution ends, the parameter setting automatically returns to \bar{OFF} .



■ **Related Parameters**

Proportional band, Integral time, Derivative time (adjustment level): Page 138
 PID ON/OFF (initial setting level): Page 149

[MWE

Communications Writing

Communications must be supported.



Function



Setting

This parameter enables/disables writing of parameters to the E5CN from the host (personal computer) using communications.

ON: Writing enabled

OFF: Writing disabled

- Default: OFF



■ **Related Parameters**

MB command logic switching (advanced function level): Page 169
 Communications Unit No., Communications baud rate, Communications data length, Communications parity, Communications stop bits (communications setting level): Page 182

[E1]

Heater Current 1 Value Monitor

Heater burnout and HS alarms must be supported.
Alarm 1 must be assigned.
The “heater burnout detection” parameter must be set to ON.



Function



Monitor

This parameter measures the heater current from the CT input used for detecting heater burnout.

This parameter measures and displays the heater current value.

- Heater burnouts are not detected if the control output (heating) ON time is 190 ms or less.

Monitor range	Unit
0.0 to 55.0	A

- FFFF is displayed when 55.0 A is exceeded.
- If a heater burnout is detected, the HA indicator will light, and the relative setting level will flash on the No. 1 display.



■ **Related Parameters**

Heater burnout detection 1, Heater burnout detection 2 (adjustment level):
Page 134

Heater burnout detection (advanced function setting level): Page 163

Error Displays [E1]: Page 206

[E2]

Heater Current 2 Value Monitor

Heater burnout and HS alarms must be supported (two CTs).
Alarm 1 must be assigned.
The “heater burnout detection” parameter must be set to ON.



Function



Monitor

This parameter measures the heater current from the CT input used for detecting heater burnout.

This parameter measures and displays the heater current value.

- Heater burnouts are not detected if the control output (heating) ON time is 190 ms or less.

Monitor range	Unit
0.0 to 55.0	A

- FFFF is displayed when 55.0 A is exceeded.
- If a heater burnout is detected, the HA indicator will light, and the relative setting level will flash on the No. 1 display.



■ **Related Parameters**

Heater burnout detection 1, Heater burnout detection 2 (adjustment level):
Page 134, Heater burnout detection (advanced function setting level): Page
163, Error Displays [E2]: Page 206

LCR1

Leakage Current 1 Monitor

Heater burnout and HS alarms must be supported.
Alarm 1 must be assigned.
The "HS alarm" parameter must be set to ON.



Function

This parameter measures the heater current from the CT input used for detecting SSR short-circuits.

This parameter measures and displays the heater current when the heater is OFF.

- HS are not detected if the control output (heating) OFF time is 190 ms or less.

Monitor range	Unit
0.0 to 55.0	A

- FFFF is displayed when 55.0 A is exceeded.
- If an SSR short-circuit is detected, the HA indicator will light, and the relative setting level will flash on the No. 1 display.



Monitor

■ **Related Parameters**

- HS alarm 1, HS alarm 2 (adjustment level): Page 135
- HS alarm use (advanced function setting level): Page 174
- Error Displays LCR1: Page 206



See

LCR2

Leakage Current 2 Monitor

Heater burnout and HS alarms must be supported (two CTs).
Alarm 1 must be assigned.
The "HS alarm" parameter must be set to ON.



Function

This parameter measures the heater current from the CT input used for detecting SSR short-circuits.

This parameter measures and displays the heater current value.

- HS are not detected if the control output (heating) OFF time is 190 ms or less.

Monitor range	Unit
0.0 to 55.0	A

- FFFF is displayed when 55.0 A is exceeded.
- If an SSR short-circuit is detected, the HA indicator will light, and the relative setting level will flash on the No. 1 display.



Monitor

■ **Related Parameters**

- HS alarm 1, HS alarm 2 (adjustment level): Page 135
- HS alarm use (advanced function setting level): Page 174
- Error Displays LCR2: Page 206



See

Hb 1

Heater Burnout Detection 1

Heater burnout and HS alarms must be supported.
Alarm 1 must be assigned.
The “heater burnout detection” parameter must be set to ON.



Function



Setting



This parameter sets the current for the heater burnout alarm to be output.

- The heater burnout alarm is output when the heater current value falls below the setting of this parameter.
- When the set value is 0.0, the heater burnout alarm is turned OFF. When the set value is 50.0, the heater burnout alarm will turn ON.

Setting range	Unit	Default
0.0 to 50.0	A	0.0

■ **Related Parameters**

Heater current 1 monitor (adjustment level): Page 132

Heater burnout detection, Heater burnout latch, Heater burnout hysteresis (advanced function setting level): Page 163

Hb2

Heater Burnout Detection 2

Heater burnout and HS alarms must be supported (two CTs).
Alarm 1 must be assigned.
The “heater burnout failure” parameter must be set to ON.



Function



Setting



This parameter sets the current for the heater burnout alarm to be output.

- The heater burnout alarm is output when the heater current value falls below the setting of this parameter.
- When the set value is 0.0, the heater burnout alarm is turned OFF. When the set value is 50.0, the heater burnout alarm will turn ON.

Setting range	Unit	Default
0.0 to 50.0	A	0.0

■ **Related Parameters**

Heater current 2 monitor (adjustment level): Page 132

Heater burnout detection, Heater burnout latch, Heater burnout hysteresis (advanced function setting level): Page 163

H5 1

HS Alarm 1

Heater burnout and HS alarms must be supported.
Alarm 1 must be assigned.
The "HS alarm" parameter must be set to ON.



Function



Setting

This parameter sets the current for the HS alarm to be output.

- The HS alarm is output when the heater current value goes above the setting of this parameter.
- When the set value is 50.0, the HS alarm is turned OFF. When the set value is 0.0, the HS alarm will turn ON.

Setting range	Unit	Default
0.0 to 50.0	A	50.0



■ **Related Parameters**

Leakage current 1 monitor (adjustment level): Page 133

HS alarm, HS alarm latch, HS alarm hysteresis (advanced function setting level): Page 174

H52

HS Alarm 2

Heater burnout and HS alarms must be supported (two CTs).
Alarm 1 must be assigned.
The "HS alarm" parameter must be set to ON.



Function



Setting

This parameter sets the current for the HS alarm to be output.

- The HS alarm is output when the heater current value goes above the setting of this parameter.
- When the set value is 50.0, the HS alarm is turned OFF. When the set value is 0.0, the HS alarm will turn ON.

Setting range	Unit	Default
0.0 to 50.0	A	50.0



■ **Related Parameters**

Leakage current 2 monitor (adjustment level): Page 133

HS alarm use, HS alarm latch, HS alarm hysteresis (advanced function setting level): Page 174

SP-0

SP 0

SP-1

SP 1

SP-2

SP 2

SP-3

SP 3

The “number of multi-SP uses” parameter must be set to 1 or 2.
The “multi-SP uses” parameter must be set to ON.



Function

These parameters set the set points when the multi-SP function is used.

The values set in these parameters can be selected by operating the keys on the front panel or by using event inputs.

- When the set point has been changed, the set value of the set point (0 to 3) selected by the multi-SP inputs is also changed to the same value.
- The decimal point position depends on the selected sensor. During analog input, it depends on the “decimal point” parameter setting.

Setting range	Unit	Default
SP lower limit to SP upper limit	EU	0



Setting



■ Related Parameters

Process value/set point (operation level): Page 120

Input type (initial setting level): Page 146

Number of multi-SP uses: Page 159, Event input 1 assignment and Event input 2 assignment, Page 160, Multi-SP uses: Page 160 (advance function setting level)

INS

Temperature Input Shift

The “input type” parameter must be set for a thermocouple or resistance thermometer, and the “input shift type” parameter must be set to a one-point shift.

Sometimes an error occurs between the set point and the actual temperature. To offset this, a compensated value can be obtained by adding an input shift value to the input. The compensated value is displayed as the measurement value and used for control.

The entire input range is shifted by a fixed rate (1-point shift). If the input shift value is set to -1°C , control will be performed for a value 1°C lower than the measured temperature.



Function



Setting

Setting range	Unit	Default
-199.9 to 999.9	$^{\circ}\text{C}$ or $^{\circ}\text{F}$	0.0



■ Related Parameters

Input type (initial setting level): Page 146

Input shift type (advanced function setting level): Page 172

↵NSH

Upper-limit Temperature Input Shift Value

The “input type” parameter must be set for a thermocouple or resistance thermometer and the “input shift type” parameter must be set to a 2-point shift, or the “input type” parameter must be set for an infrared sensor.

↵NSL

Lower-limit Temperature Input Shift Value

The “input type” parameter must be set for a thermocouple or resistance thermometer and the “input shift type” parameter must be set to a 2-point shift, or the “input type” parameter must be set for an infrared sensor.

These parameters are used to shift the input temperature at two points: an upper-limit temperature and a lower-limit temperature (as opposed to the “temperature input shift” parameter, which shifts the input temperature by setting the shift for only one point). A 2-point shift enables more accurate offset of the input range compared with a 1-point shift if the input shift values at the upper and lower limits differ.

This parameter sets input shift values for the upper and lower limits (2-point shift) of the input range.



Function



Setting

Setting range	Unit	Default
-199.9 to 999.9	°C or °F	0.0



See

■ Related Parameters

Input type (initial setting level): Page 146

Input shift type (advanced function setting level): Page 172

P
I
d

Proportional Band
Integral Time
Derivative Time

The control must be set to 2-PID control.



Function

These parameters set PID control constants. PID constants are automatically set when AT or ST is executed.

P action: Refers to control in which the MV is proportional to the deviation (control error).

I action: Refers to a control action that is proportional to the time integral of the deviation. With proportional control, there is normally an offset (control error). Proportional action is thus used in combination with integral action. As time passes, this control error disappears, and the control temperature (process value) comes to agree with the set point.

D action: Refers to a control action that is proportional to the time derivative of the control error. The proportional control and integral control correct for errors in the control result, and thus the control system is late in responding to sudden changes in temperature. The derivative action increases the MV in proportion to the slope of the change in the temperature as a corrective action.



Setting

Parameters	Models	Setting range		Unit	Default
Proportional band	Controllers with Thermocouple/Resistance Thermometer Multi-inputs	0.1 to 999.9		°C or °F (See note 1.)	8.0
	Controllers with Analog Inputs			%FS	10.0
Integral time		0 to 3999		Second	233
Derivative time		RT is OFF.	0 to 3999	Second	40
		RT is ON.	0.0 to 999.9	Second	40.0

- Note**
- (1) Set “none” as the unit for Controllers with Analog Inputs.
 - (2) If the settings for RT (robust tuning) are changed, the proportional band (P), integral time (I), and derivative time (D) will be initiated.

■ **Related Parameters**

AT execute/cancel (adjustment level): Page 131



[-5[

Cooling Coefficient

The control must be heating/cooling control and 2-PID control.

If the heating characteristics and cooling characteristics of the control object are very different and good control characteristics cannot be achieved with the same PID constants, the cooling coefficient can be used to adjust the proportional band (P) for the control output assigned to the cooling side.

In heating/cooling control, the proportional band P for the cooling control output is calculated using the following formula to set the cooling coefficient:

$$\text{Cooling control output side P} = \text{Cooling coefficient} \times \text{P (proportional band)}$$



Function



Setting

Setting range	Unit	Default
0.01 to 99.99	None	1.00

■ Related Parameters

Proportional band (adjustment level): Page 138



[-db

Dead Band

The control system must be set to heating/cooling control.

This parameter sets the output dead band width for heating/cooling control. A negative setting sets an overlapping band.

- This parameter sets an area in which the control output is 0 centering around the set point for a heating/cooling control.
- During temperature input, the decimal point position depends on the currently selected sensor, and during analog input it depends on the “decimal point” parameter setting.



Function



Setting

Model	Setting range	Unit	Default
Controllers with Thermocouple/Resistance Thermometer Multi-inputs	-199.9 to 999.9	°C or °F (See note.)	0.0
Controllers with Analog Inputs	-19.99 to 99.99	%FS	0.00

Note Set “none” as the unit for Controllers with Analog Inputs.

$\bar{\alpha}F-R$

Manual Reset Value

The control must be standard control and 2-PID control. The “integral time” parameter must be set to 0.



Function



Setting

- This parameter sets the required manipulated variable to remove offset during stabilization of P or PD control.

Setting range	Unit	Default
0.0 to 100.0	%	50.0

■ **Related Parameters**

- Integral time (adjustment level): Page 138
- PID ON/OFF (initial setting level): Page 149



HYS

Hysteresis (Heating)

The control must be ON/OFF control. For the “hysteresis (cooling)” parameter, the control must be heating/cooling control.

[HYS

Hysteresis (Cooling)

This parameter sets the hysteresis for ensuring stable operation at the ON/OFF switching point.



Function

- For standard control, use the “hysteresis (heating)” parameter. The “hysteresis (cooling)” parameter cannot be used.
- For heating/cooling control, the hysteresis can be set independently for heating/cooling. The “hysteresis (heating)” parameter is used for the heating side, and the “hysteresis (cooling)” parameter is used for the cooling side.



Setting

Parameters	Model	Setting range	Unit	Default
Hysteresis (heating)	Controllers with Thermocouple/Resistance Thermometer Multi-inputs	0.1 to 999.9	°C or °F (See note.)	1.0
	Controllers with Analog Inputs	0.01 to 99.99	%FS	0.10
Hysteresis (cooling)	Controllers with Thermocouple/Resistance Thermometer Multi-inputs	0.1 to 999.9	°C or °F (See note.)	1.0
	Controllers with Analog Inputs	0.01 to 99.99	%FS	0.10

Note Set “none” as the unit for Controllers with Analog Inputs.

■ **Related Parameters**

- PID ON/OFF, Standard or heating/cooling (initial setting level): Page 149



50RI

Soak Time

The “program pattern” parameter must not be set to OFF.



Function

- This parameter sets the time for the control operation when using the simple program function.



Setting

Setting range	Unit	Default
1 to 9999	min or h	1



■ **Related Parameters**

- Program start, Soak time remain (operation level): Page 123
- Wait band (adjustment level): Page 141
- Program pattern (initial setting level): Page 151
- Soak time unit (advanced function setting level): Page 181

WT-b

Wait Band

The “program pattern” parameter must not be set to OFF.



Function

- This parameter sets the stable band within which the soak time is measured for the simple program function.



Setting

Model	Setting range	Unit	Default
Controllers with Thermocouple/Resistance Thermometer Multi-inputs	OFF or 0.1 to 999.9	°C or °F (See note.)	OFF
Controllers with Analog Inputs	OFF or 0.01 to 99.99	%FS	

Note Set “none” as the unit for Controllers with Analog Inputs.



■ **Related Parameters**

- Program start, Soak time remain (operation level): Page 123
- Soak time (adjustment level): Page 141
- Program pattern (initial setting level): Page 151
- Soak time unit (advanced function setting level): Page 181

MV-5**MV at Stop**

The control must be set to 2-PID control.
The "MV at stop and error addition" parameter must be ON.



Function



Setting

- This parameter sets the MV to use when the RUN/STOP status changes from RUN to STOP.

Setting range	Unit	Default
-5.0 to 105.0 for standard control	%	0.0
-105.0 to 105.0 (heating/cooling control)		

■ **Related Parameters**

RUN/STOP (operation level): Page 124

MV at stop and error addition (advance function setting level): Page 173



See

MV-E**MV at PV Error**

The control must be set to 2-PID control.
The "MV at stop and error addition" parameter must be ON.



Function



Setting

- This parameter sets the MV to use when an input error occurs.

Setting range	Unit	Default
-5.0 to 105.0 for standard control	%	0.0
-105.0 to 105.0 (heating/cooling control)		

■ **Related Parameters**

MV at stop and error addition (advance function setting level): Page 173



See

SPRt

SP Ramp Set Value

The “ST” parameter must be set to OFF.



- This parameter sets the rate of change during SP ramp operation. Set the maximum permissible change width per unit of time as the SP ramp set value. The SP ramp function is disabled if this parameter is set to OFF.
- During temperature input, the decimal point position of the SP ramp set value is dependent on the currently selected sensor, and during analog input it is dependent on scaling.



Setting range	Unit	Default
OFF or 1 to 9999	EU/s or EU/minute	OFF



■ **Related Parameters**

Input type: Page 146, Scaling upper limit, Scaling lower limit, Decimal point (initial setting level): Page 148, ST: Page 150 (initial setting level)
 SP ramp time unit (advance function setting level): Page 161

oL -H

MV Upper Limit

The control must be set to 2-PID control.

oL -L

MV Lower Limit

The “ST” parameter must be set to OFF.



- The “MV upper limit” and “MV lower limit” parameters set the upper and lower limits of the manipulated variable. When the calculated manipulated variable exceeds the upper or lower limit value, the upper or lower limit value will be the output level.
- MV Upper Limit
 The setting ranges during standard control and heating/cooling control are different.
 The manipulated variable for the cooling control output side during heating/cooling control is expressed as a negative value.



Control method	Setting range	Unit	Default
Standard	MV lower limit + 0.1 to 105.0	%	105.0
Heating/cooling	0.0 to 105.0		

- MV Lower Limit
 The setting ranges during standard control and heating/cooling control are different. The manipulated variable for the cooling control output side during heating/cooling control is expressed as a negative value.

Control method	Setting range	Unit	Default
Standard	-5.0 to MV upper limit - 0.1	%	-5.0
Heating/cooling	-105.0 to 0.0		-105.0



■ **Related Parameters**

PID ON/OFF: Page 149, ST: Page 150 (initial setting level)

5-5 Manual Control Level

The manipulated variable can be set in manual mode if the “PV/MV” parameter is displayed.

The final MV used in automatic mode will be used as the initial manual MV when moving from automatic mode to manual mode. In manual mode, the change value will be fixed immediately and reflected in the actual MV.

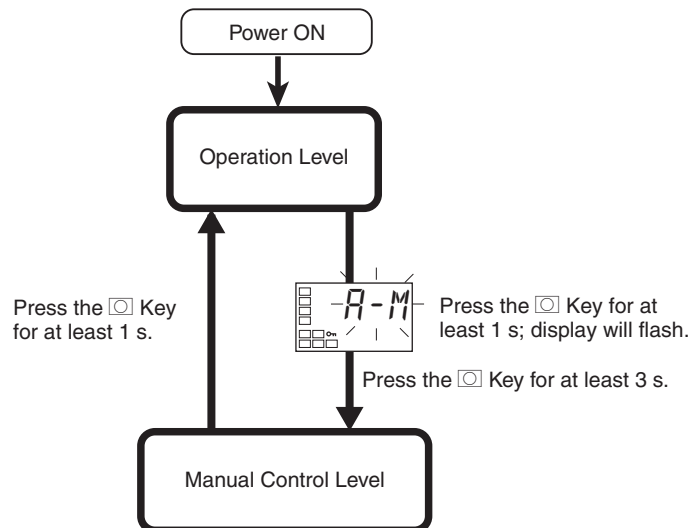

To move from the operation level to the manual control level, press the [Key] key for at least three seconds with the “auto/manual switch” parameter displayed.

- The MANU indicator will light during manual control.
- It is not possible to move to any displays except for the “PV/MV” parameter during manual operation.
- To return to the operation level, press the [Key] key in the manual control level for at least one second.

PV/MV (Manual MV)



Function

The process value is displayed on the No. 1 display, and the manipulated variable (manual MV) is displayed on the No. 2 display.

Monitor range		Unit
Process value	Input indication range (See page 219.)	EU

Setting range		Unit
MV (manual MV)	Standard control	-5.0 to 105.0
	Heating/cooling control	-105.0 to 105.0

■ **Related Parameters**

Standard or heating/cooling (initial setting level): Page 150



5-6 Initial Setting Level

This level is used to set up the basic Temperature Controller specifications. In this level, you can set the “input type” parameter to set the sensor input to be connected, limit the setting range of set points, set the alarm modes, and perform other operations.

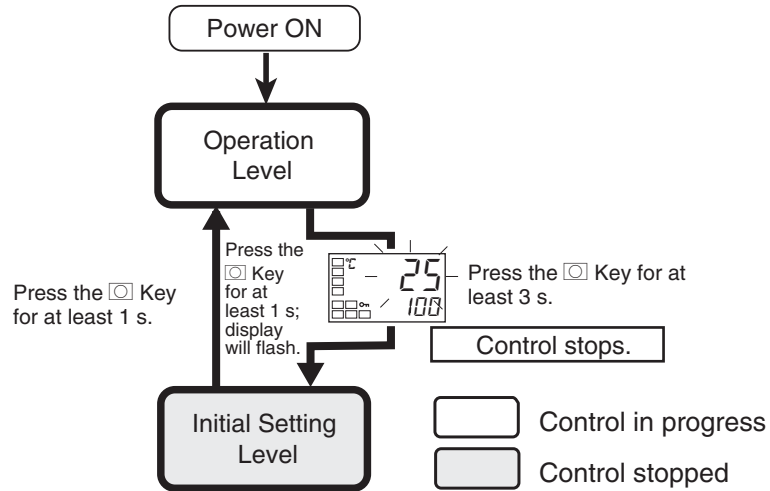

To move from the operation level to the initial setting level, press the key for at least three seconds with any parameter displayed except for the “auto/manual switch” parameter.

- The initial setting level is not displayed when the “initial/communications protect” parameter is set to 2. It can be used when the “initial/communications protect” parameter is set to 0 or 1.
- If the “input type” parameter is set for an analog input, the following parameters will be set: Scaling upper limit, Scaling lower limit, and Decimal point.

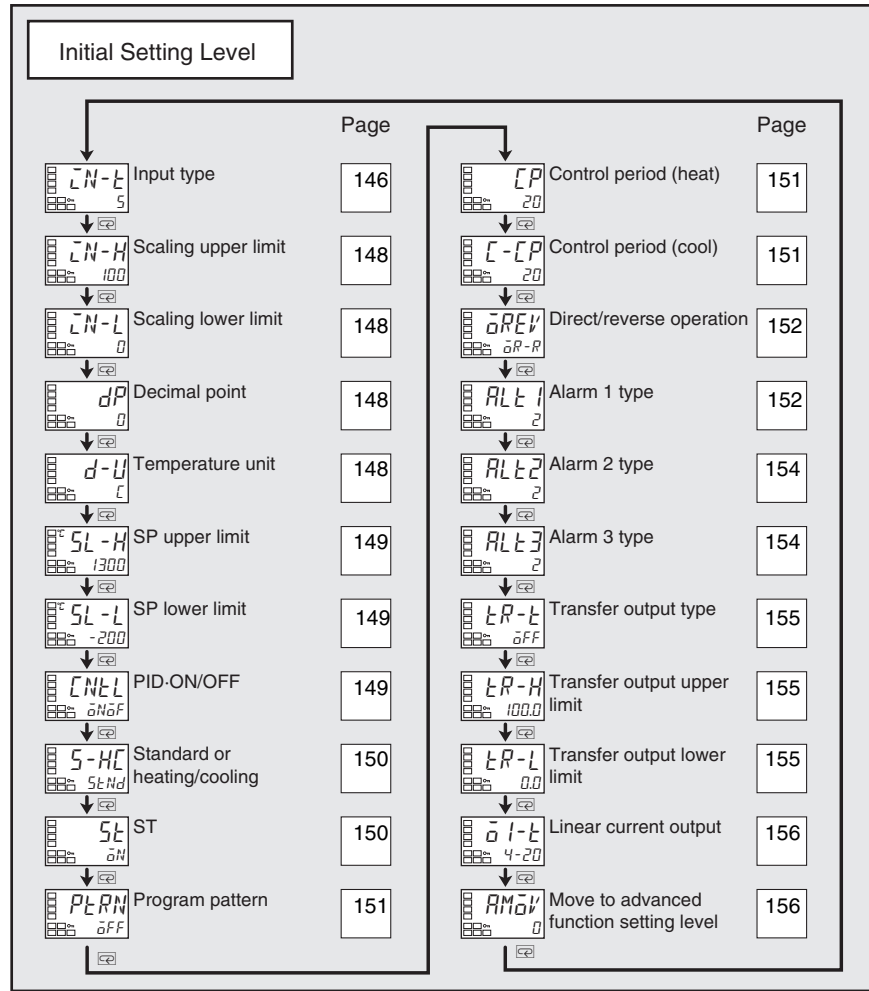

IN-E Input Type



Function



Setting

- This parameter sets the type of sensor.
- When this parameter is changed, the set point limiter is changed to the defaults. If the input type must be changed, set the “SP upper limit” and “SP lower limit” parameters (initial setting level).
- Set one of the set values from the following table.
The defaults are as follows:
Controllers with Thermocouple/Resistance Thermometer Multi-inputs:
5 (K thermocouple)
Controllers with Analog Inputs: 0 (current input, 4 to 20 mA)
- If a platinum resistance thermometer is mistakenly connected while a setting for other than a platinum resistance thermometer is in effect, S.ERR will be displayed. To clear the S.ERR display, check the wiring and then cycle the power.

	Input type	Specifications	Set value	Input temperature range
Controllers with Thermocouple/Resistance Thermometer Multi-inputs	Platinum resistance thermometer	Pt100	0	-200 to 850 (°C)/-300 to 1,500 (°F)
			1	-199.9 to 500.0 (°C)/-199.9 to 900.0 (°F)
			2	0.0 to 100.0 (°C)/0.0 to 210.0 (°F)
		JPt100	3	-199.9 to 500.0 (°C)/-199.9 to 900.0 (°F)
	4		0.0 to 100.0 (°C)/0.0 to 210.0 (°F)	
	Thermocouple	K	5	-200 to 1,300 (°C)/-300 to 2,300 (°F)
			6	-20.0 to 500.0 (°C)/0.0 to 900.0 (°F)
		J	7	-100 to 850 (°C)/-100 to 1,500 (°F)
			8	-20.0 to 400.0 (°C)/0.0 to 750.0 (°F)
		T	9	-200 to 400 (°C)/-300 to 700 (°F)
			10	-199.9 to 400.0 (°C)/-199.9 to 700.0 (°F)
		E	11	0 to 600 (°C)/0 to 1,100 (°F)
		L	12	-100 to 850 (°C)/-100 to 1,500 (°F)
		U	13	-200 to 400 (°C)/-300 to 700 (°F)
			14	-199.9 to 400.0 (°C)/-199.9 to 700.0 (°F)
		N	15	-200 to 1,300 (°C)/-300 to 2,300 (°F)
		R	16	0 to 1,700 (°C)/0 to 3,000 (°F)
		S	17	0 to 1,700 (°C)/0 to 3,000 (°F)
		B	18	100 to 1,800 (°C)/300 to 3,200 (°F)
	Infrared Temperature Sensor ES1B	10 to 70 (°C)	19	0 to 90 (°C)/0 to 190 (°F)
		60 to 120 (°C)	20	0 to 120 (°C)/0 to 240 (°F)
		115 to 165 (°C)	21	0 to 165 (°C)/0 to 320 (°F)
140 to 260 (°C)		22	0 to 260 (°C)/0 to 500 (°F)	
Analog input	0 to 50 mV	23	One of the following ranges depending on the scaling. -1,999 to 9,999 -199.9 to 999.9	

	Input type	Specifications	Set value	Input temperature range
Controllers with Analog Inputs	Current input	4 to 20 mA	0	One of the following ranges depending on the scaling. -1,999 to 9,999 -199.9 to 999.9 -19.99 to 99.99 -1.999 to 9.999
		0 to 20 mA	1	
	Voltage input	1 to 5 V	2	
		0 to 5 V	3	
		0 to 10 V	4	



■ Related Parameters

Temperature unit, Set point upper limit, Set point lower limit (initial setting level): Page 148

LN-H
LN-L
dP

Scaling Upper Limit
Scaling Lower limit
Decimal Point

The input type must be set for an analog input.



- These parameters can be used when the input type is set for an analog input.
- When an analog input is used, scaling is performed. Set the upper limit in the “scaling upper limit” parameter and the lower limit in the “scaling lower limit” parameter.
- The “decimal point” parameter specifies the decimal point position of parameters (set point, etc.) whose unit is EU.
- Scaling Upper Limit, Scaling Lower Limit



Parameters	Setting range	Unit	Default
Scaling upper limit	Scaling lower limit + 1 to 9999	None	100
Scaling lower limit	-1999 to scaling upper limit - 1	None	0

- Decimal Point

Parameters	Model	Setting range	Default
Decimal Point	Controllers with Thermocouple/Resistance Thermometer Multi-inputs	0 to 1	0
	Controllers with Analog Inputs	0 to 3	0

Set value	Settings	Example
0	0 digits past decimal point	1234
1	1 digits past decimal point	123.4
2	2 digits past decimal point	12.34
3	3 digits past decimal point	1.234

■ **Related Parameters**

Input type (initial setting level): Page 146



d-U

Temperature Unit

The input type must be set for a temperature input.



- Set the temperature input unit to either °C or °F.



Setting range	Default
[]: °C, F: °F	[]

■ **Related Parameters**

Input type (initial setting level): Page 146



5L-H SP Upper Limit
5L-L SP Lower Limit



- These parameters set the upper and lower limits of the set points. A set point can be set within the range defined by the upper and lower limit set values in the “SP upper limit” and “SP lower limit” parameters. If these parameters are reset, any set point that is outside of the new range will be forcibly changed to either the upper limit or the lower limit.
- When the temperature input type and temperature unit have been changed, the set point upper limit and set point lower limit are forcibly changed to the upper and lower limits of the sensor.
- During temperature input, the decimal point position depends on the currently selected sensor, and during analog input it depends on the “decimal point” parameter setting.



Controllers with Thermocouple/Resistance Thermometer Multi-inputs

Parameters		Setting range	Unit	Default
Set point upper limit	Temperature	SP lower limit + 1 to Input range upper limit	EU	1300
	Analog	SP lower limit + 1 to scaling upper limit	EU	100
Set point lower limit	Temperature	Input range lower limit to SP upper limit - 1	EU	-200
	Analog	Scaling lower limit to SP upper limit - 1	EU	0

Controllers with Analog Inputs

Parameters	Setting range	Unit	Default
Set point upper limit	SP lower limit + 1 to scaling upper limit	EU	100
Set point lower limit	Scaling lower limit to SP upper limit - 1	EU	0



■ **Related Parameters**

Input type: Page 146, Temperature unit: Page 148 (initial setting level)

ENL PID ON/OFF



- This parameter selects 2-PID control or ON/OFF control.
- The auto-tuning and self-tuning functions can be used in 2-PID control.



Setting range	Default
P _L d: 2-PID, $\bar{a}N\bar{o}F$: ON/OFF	$\bar{a}N\bar{o}F$



■ **Related Parameters**

AT execute/cancel: Page 131, Manual reset, Hysteresis (heating), and Hysteresis (cooling): Page 140 (adjustment level)
 ST stable range (advanced function setting level): Page 165

5-H

Standard or Heating/Cooling



Function



Setting

- This parameter selects standard control or heating/cooling control.
- With the E5CN and E5CN-U, when heating/cooling control is selected, alarm output 2 terminal (ALM2) is used as a control output (cooling), so alarm 2 cannot be used.
- With the E5AN and E5EN, when heating/cooling control is selected, alarm output 3 terminal (ALM3) is used as a control output (cooling), so alarm 3 cannot be used.

Setting range	Default
<i>StNd</i> : Standard, <i>H-C</i> : Heating/cooling	<i>StNd</i>



■ **Related Parameters**

MV monitor (heating): Page 127, MV monitor (cooling): Page 128 (operation level)
 Cooling coefficient, Dead band: Page 139, Hysteresis (heating), Hysteresis (cooling): Page 140 (adjustment level)
 Control period (heat), Control period (cool) (initial setting level): Page 151
 Control output 1 assignment: Page 177, Control output 2 assignment, Alarm 1 assignment: Page 178, Alarm 2 assignment: Page 179, Alarm 3 assignment: Page 180 (advance function setting level)

5t

ST (self-tuning)

The control must be set to a temperature input, standard control, and 2-PID control.



Function



Setting

- The ST (self-tuning) function executes tuning from the start of program execution to calculate PID constants matched to the control target. When the ST function is in operation, be sure to turn ON the power supply of the load connected to the control output simultaneously with or before starting Controller operation.
- Auto-tuning can be started during self-tuning.

Parameter	Setting range	Unit	Default
ST	<i>oFF</i> : ST function OFF, <i>oN</i> : ST function ON	None	<i>oN</i>



■ **Related Parameters**

Input type: Page 146, PID ON/OFF: Page 149 (initial setting level), ST stable range (advance function setting level): Page 165

PLRN

Program Pattern

This parameter sets the type of control when using the simple program function.



- If the program pattern is set to OFF, the simple program will not operate.
- If the program pattern is set to STOP, the RUN/STOP status will change to STOP after the soak time has expired. If the program pattern is set to CONT, control will continue in RUN status after the soak time has expired.

	Setting range	Default
OFF	Simple program function turned OFF	OFF
STOP	Go to STOP mode at end of program.	
CONT	Continue in RUN mode at end of program.	



■ **Related Parameters**

Program start, Soak time remain: Page 123, RUN/STOP: Page 124 (operation level)

Soak time, Wait band (adjustment level): Page 141

Soak time unit (advanced function setting level): Page 181

[P

Control Period (Heat)

The cooling control output and heating control output must be assigned to relay/voltage outputs.

]-[P

Control Period (Cool)

The control must be set to 2-PID control.
For the “control period (cool)” parameter, the control must be set to heating/cooling control.



- These parameters set the output periods. Set the control periods taking the control characteristics and the electrical durability of the relay into consideration.
- For standard control, use the “control period (heat)” parameter. The “control period (cool)” parameter cannot be used.
- Whenever the heating control output is a current output, the “control period (heat)” parameter cannot be used.
- For heating/cooling control, the control period can be set independently for heating and cooling. The “control period (heat)” parameter is used for the heating control output, and the “control period (cool)” parameter is used for the cooling control output.

Parameters	Setting range	Unit	Default
Control period (heat)	0.5 or 1 to 99	Second	20
Control period (cool)	0.5 or 1 to 99	Second	20



■ **Related Parameters**

PID ON/OFF (initial setting level): Page 149

REV

Direct/Reverse Operation



Function



Setting

- “Direct operation” refers to control where the manipulated variable is increased when the process value increases. Alternatively, “reverse operation” refers to control where the manipulated variable is increased when the process value decreases.

Setting range	Default
$\bar{a}R-R$: Reverse operation, $\bar{a}R-d$: Direct operation	$\bar{a}R-R$

AL1

Alarm 1 Type

Alarm 1 must be assigned.



Function



Setting

- Select one of the following three alarm 1 types: Deviation, Deviation range, or Absolute value

Set values	Alarm type	Alarm output operation	
		When alarm value X is positive	When alarm value X is negative
0	Alarm function OFF	Output OFF	
1 (See note 1.)	Upper- and lower-limit		See note 2.
2	Upper-limit		
3	Lower-limit		
4 (See note 1.)	Upper- and lower-limit range		See note 3.
5 (See note 1.)	Upper- and lower-limit with standby sequence		See note 4.
6	Upper-limit with standby sequence		
7	Lower-limit with standby sequence		
8	Absolute-value upper-limit		
9	Absolute-value lower-limit		

Set values	Alarm type	Alarm output operation	
		When alarm value X is positive	When alarm value X is negative
10	Absolute-value upper-limit with standby sequence		
11	Absolute-value lower-limit with standby sequence		
12	LBA (alarm 1 type only)	---	

- Note**
- (1) With set values 1, 4 and 5, the upper- and lower- limit values can be set independently for each alarm type, and are expressed as “L” and “H.”
 - (2) Set value: 1 (Upper- and lower-limit alarm)

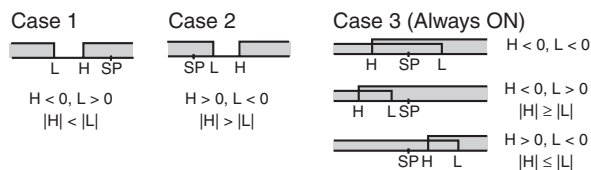

- (3) Set value: 4 (Lower limit range)

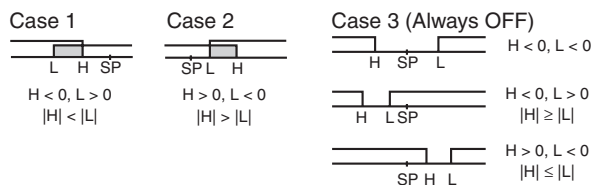

- (4) Set value: 5 (Upper- and lower-limit with standby sequence)
 - For the lower-limit alarms in cases 1 and 2 above, the alarm is normally OFF if upper- and lower-limit hysteresis overlaps.
 - In case 3, the alarm is always OFF.
- (5) Set value: 5 (The alarm is always OFF if upper- and lower-limit alarm hysteresis with standby sequence overlaps.)
 - Set the alarm type independently for each alarm in the “alarm 1 to 3 type” parameters in the initial setting level. The default is 2 (Upper-limit alarm).



■ **Related Parameters**

Alarm value 1: Page 124, Alarm value upper limit 1, Alarm value lower limit 1: Page 126 (operation level)

Standby sequence reset: Page 161, Alarm 1 open in alarm: Page 162, Alarm 1 hysteresis: Page 163, Alarm 1 latch: Page 167 (advanced function setting level)

RLLE2

Alarm 2 Type

Alarm 2 must be assigned.



Function

- Select one of the following three alarm 2 types:
Deviation, Deviation range, or Absolute value



Setting

Refer to the alarm 1 type list.



■ **Related Parameters**

Alarm value 2: Page 125, Alarm value upper limit 2, Alarm value lower limit 2: Page 126 (operation level)

Standby sequence reset: Page 161, Alarm 2 open in alarm: Page 162, Alarm 2 hysteresis: Page 163, Alarm 2 latch: Page 167 (advanced function setting level)

RLLE3

Alarm 3 Type

Alarm 3 must be assigned.



Function

- Select one of the following three alarm 3 types:
Deviation, Deviation range, or Absolute value



Setting

Refer to the alarm 1 type list.



■ **Related Parameters**

Alarm value 3: Page 125, Alarm value upper limit 3, Alarm value lower limit 3: Page 127 (operation level)

Standby sequence reset: Page 161, Alarm 3 open in alarm: Page 162, Alarm 3 hysteresis: Page 163, Alarm 3 latch: Page 167 (advanced function setting level)

LR-L

Transfer Output Type

A current output must be assigned.



Function

- When current output is to be used as transfer output, this parameter sets the transfer output type.
- If current output is not to be used as transfer output, set this parameter to OFF.



Setting

Transfer output type		Default
OFF	OFF	OFF
Set point	SP	
Set point during SP ramp	SP-M	
PV	PV	
MV monitor (heating)	MV	
MV monitor (cooling)	E-MV	

■ **Related Parameter**

Transfer output upper limit, Transfer output lower limit (initial setting level):
Page 155



LR-H

Transfer Output Upper Limit

A current output must be assigned.
The transfer output type must not be set to OFF.

LR-L

Transfer Output Lower Limit



Function

- This parameter sets the upper and lower limit values of transfer outputs.



Setting

Transfer output type	Setting range		Default		Unit
			Transfer output lower limit	Transfer output upper limit	
Set point	SP lower limit to SP upper limit		SP lower limit	SP upper limit	EU
Set point during SP ramp	SP lower limit to SP upper limit				
PV	Temperature	Senor setting range lower limit to sensor setting range upper limit	Sensor setting range lower limit	Sensor setting range upper limit	
	Analog	Analog scaling lower limit to analog scaling upper limit	Scaling lower limit	Scaling upper limit	
MV monitor (heating)	Standard	-5.0 to 105.0	0.0	100.0	%
	Heating/cooling	0.0 to 105.0			
MV monitor (cooling)	0.0 to 105.0				

■ **Related Parameter**

Transfer output type (initial setting level): Page 155



01-E

Linear Current Output

A current output must be assigned.



Function



Setting

This parameter selects the output type for linear current outputs.

- Select either 4 to 20 mA or 0 to 20 mA.

Transfer type	Default
4-20: 4 to 20 mA	4-20
0-20: 0 to 20 mA	

■ **Related Parameter**

Transfer output type (initial setting level): Page 155

See



RM0V

Move to Advanced Function Setting Level

The “initial setting/communications protect” parameter must be set to 0.



Function

- Set the “move to advanced setting level” parameter set value to “-169.”
- Move to the advanced setting level either by pressing the  key or  key or by waiting for two seconds to elapse.

See



■ **Related Parameter**

Initial setting/communications protect (protect level): Page 116

5-7 Advanced Function Setting Level

The advanced function setting level is used for optimizing Controller performance. To move to this level, input the password (“-169”) from the initial setting level.

To be able to enter the password, the “initial setting/communications protect” parameter in the protect level must be set to 0.

- The parameters in this level can be used when the “initial setting/communications protect” parameter is set to 0.
- To switch between setting levels, press the  key.
- To change set values, press the  and  keys.

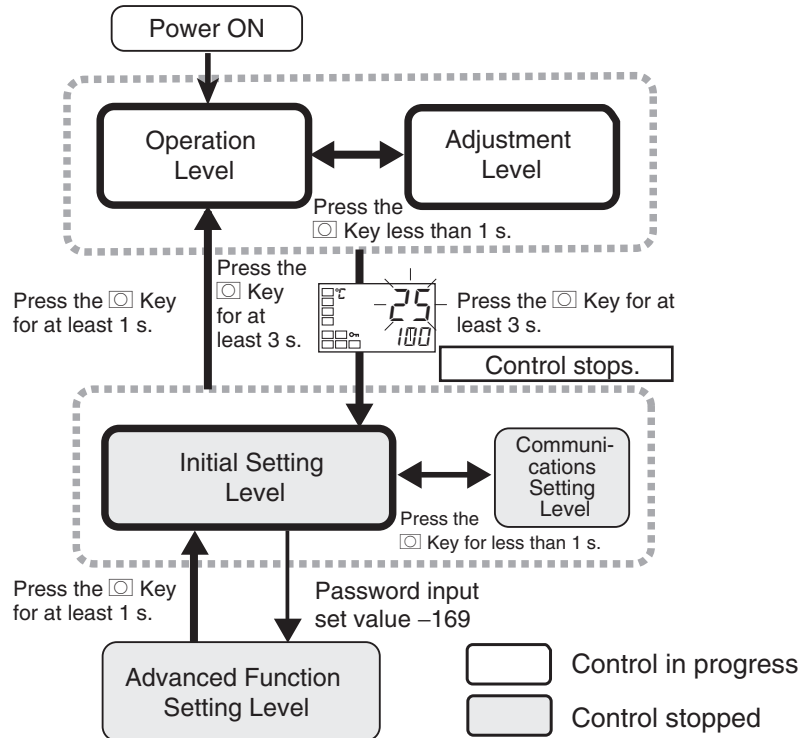

Advanced Function Setting Level		Page	Page	Page	Page
CNLT 000 0FF	Parameter initialization	158	HbL 000 0FF	Heater burnout latch	164
EV-M 000 0.1	Number of multi-SP uses	159	HbH 000 0.1	Heater burnout hysteresis	164
EV-1 000 N0NE	Event input assignment 1	160	St-b 000 15.0	ST stable range	165
EV-2 000 St 0P	Event input assignment 2	160	ALFA 000 0.65	α	165
MSPU 000 0FF	Multi-SP uses	160	CNF 000 0.0	Input digital filter	166
SPRU 000 M	SP ramp time unit	161	PVAd 000 0FF	Additional PV display	166
RESL 000 R	Standby sequence reset	161	0-dP 000 0FF	MV display	166
AL IN 000 N-0	Alarm 1 open in alarm	162	RET 000 0FF	Display auto-return time	167
ALH1 000 0.2	Alarm 1 hysteresis	163	AL1L 000 0FF	Alarm 1 latch	167
AL2N 000 N-0	Alarm 2 open in alarm	162	AL2L 000 0FF	Alarm 2 latch	167
ALH2 000 0.2	Alarm 2 hysteresis	163	AL3L 000 0FF	Alarm 3 latch	167
AL3N 000 N-0	Alarm 3 open in alarm	162	PRL 000 3	Move to protect level time	168
ALH3 000 0.2	Alarm 3 hysteresis	163	SER0 000 0FF	Input error output	168
HbU 000 0N	HB ON/OFF	163	CJC 000 0N	Cold junction compensation method	168
			ALRV 000 0FF	MB command logic switching	169
			COLR 000 REd	PV display color	169
			PV-b 000 5.0	PV stable band	170
			AL1N 000 0	Alarm 1 ON delay	171
			AL2N 000 0	Alarm 2 ON delay	171
			AL3N 000 0	Alarm 3 ON delay	171
			AL1O 000 0	Alarm 1 OFF delay	172
			AL2O 000 0	Alarm 2 OFF delay	172
			AL3O 000 0	Alarm 3 OFF delay	172
			CSLP 000 C N S I	Input shift type	172
			MVSE 000 0FF	MV at stop and error addition	173
			AMAd 000 0FF	Auto/manual select addition	173
			RT 000 0	RT	174
			HSU 000 0N	HS alarm use	174
			HSL 000 0FF	HS alarm latch	175
			HSH 000 0.1	HS alarm hysteresis	175
			LbAL 000 0	LBA detection time	176
			LbAL 000 8.0	LBA level	176
			LbAb 000 3.0	LBA band	177
			OUT1 000 0	Control output 1 assignment	177
			OUT2 000 N0NE	Control output 2 assignment	178
			ALM1 000 AL M 1	Alarm 1 assignment	178
			ALM2 000 AL M 2	Alarm 2 assignment	179
			ALM3 000 AL M 3	Alarm 3 assignment	180
			CSEL 000 0N	Character select	180
			t-U 000 M	Soak time unit	181
			ALSP 000 SP-M	Alarm SP selection	181
			CM0V 000 0	Move to calibration level	181

CNLT

Parameter Initialization



Function



Setting

- This parameter returns all parameter settings to their defaults.
- After the initialization, the set value automatically turns 0FF.

Setting range	Default
0FF: Initialization is not executed.	0FF
FALC: Initializes to the factory settings described in the manual.	

EV - M

Number of Multi-SP Uses

Event inputs must be supported.



Function



Setting

Multi-SP is a function for setting set points 0 to 3 in advance, and switching between these set points using the ON/OFF combinations of event inputs 1 and 2.

The “number of multi-SP uses” parameter is used when the number of preset set points is either two or four.

This parameter determines whether the “event input assignment 1” and “event input assignment 2” parameters are displayed.

The “number of multi-SP uses” parameter displays which functions are assigned to event inputs 1 and 2.

		Settings		Event inputs	
		Event input assignment 1	Event input assignment 2	Function of event input 1	Function of event input 2
Number of multi-SP uses	0 (See note 1.)	NONE, STOP, MANU, PRST (See note 2.)		None, or switching RUN/STOP, auto/manual, or program starts	
	1	(Not displayed.)	NONE, STOP, MANU, PRST (See note 2.)	Multi-SP, 2 points (switching set points 0 and 1)	None, or switching RUN/STOP, auto/manual, or program starts
	2	(Not displayed.)		Multi-SP, 4 points (switching set points 0, 1, 2, 3)	

Note

(1) If the “number of multi-SP uses” parameter is set to 0, both input assignments 1 and 2 can be set. Once “STOP” (RUN/STOP), “MANU” (auto/manual), or “PRST” (program start) has been assigned to one event input, the other event can be assigned only to either of the remaining two settings.

(2) “PRST” (program start) can be set only when the “program pattern” parameter has not be set to OFF.

If the “program pattern” parameter is set to OFF (i.e., if the simple program mode is not selected) when “PRST” (program start) is set, the assignment of the input will automatically be changed to “NONE.”

- Default: 1

Multi-SP switching by event inputs can be used with Controllers that have event inputs, when the “number of multi-SP uses” parameter is set to 1 or 2.

The following tables show the relationships between ON/OFF combinations of event inputs 1 and 2 and selected set points.

Number of Multi-SP Uses: 1

Event input 1	Selected set point
OFF	Set point 0
ON	Set point 1

Number of Multi-SP Uses: 2

Event input 1	Event input 2	Selected set point
OFF	OFF	Set point 0
ON	OFF	Set point 1

Event input 1	Event input 2	Selected set point
OFF	ON	Set point 2
ON	ON	Set point 3

Note Event inputs can be used on E5□N-□□□B□ Controllers. Turn the event inputs ON or OFF while the power is turned ON. Event input ON/OFF changes are detected for inputs of 50 ms or longer.



■ **Related Parameters**

SP 0 to SP 3 (adjustment level): Page 136

Event input assignment 1, Event input assignment 2: Page 160, Multi-SP uses: Page 160 (advanced function setting level)

EV-1
EV-2

Event Input Assignment 1
Event Input Assignment 2

Event inputs must be supported. The “number of multi-SP uses” parameter must be set to 0 or 1.



- The following functions are assigned for event input 1 and event input 2.
RUN/STOP
Auto/manual switch
Program start



- Defaults: Event input assignment 1: *NONE*
Event input assignment 2: *STOP*

Settings	Function
<i>NONE</i>	None
<i>STOP</i>	RUN/STOP
<i>MANU</i>	Auto/manual switch
<i>PRSE</i>	Program start (See note.)

Note This parameter can be set when the program pattern is not set to OFF.



■ **Related Parameters**

SP 0 to SP 3 (adjustment level): Page 136,

Number of multi-SP uses (advanced function setting level): Page 159

MSPU

Multi-SP Uses

The model must not support event inputs, or the number of multi-SP uses must be 0.



This parameter enables switching between set points 0 to 3 by operating the keys on the front panel.

Prerequisites

- A model without event inputs
- The “number of multi-SP uses” parameter set to 0 on a model with event inputs

ON: Set points 0 to 3 can be selected.

OFF: Set points 0 to 3 cannot be selected.

- Default : OFF





■ **Related Parameters**

- Multi-SP set point setting (operation level): Page 120
- Number of multi-SP uses (advanced function setting level): Page 159

SPRU

SP Ramp Time Unit

The "ST" parameter must be set to OFF.



- This parameter sets the time unit for the rate of change during SP ramp operation.



Setting range	Default
5: EU/s, M: EU/min	M

■ **Related Parameters**

- Ramp SP monitor (operation level): Page 121
- SP ramp set value (adjustment level): Page 143

RESL

Standby Sequence Reset

The alarm 1/2/3 type must be set to a type with a standby sequence.



- This parameter selects the conditions for enabling reset after the standby sequence of the alarm has been canceled.
- Output is turned OFF when switching to the initial setting level, communications setting level, advanced function setting level, or calibration level.
- Condition A
Control started (including power ON), and set point, alarm value (alarm value upper/lower limit), or input shift value (upper/lower-limit temperature input shift value) changed.
- Condition B
Power ON
- The following example shows the reset action when the alarm type is lower-limit alarm with standby sequence.

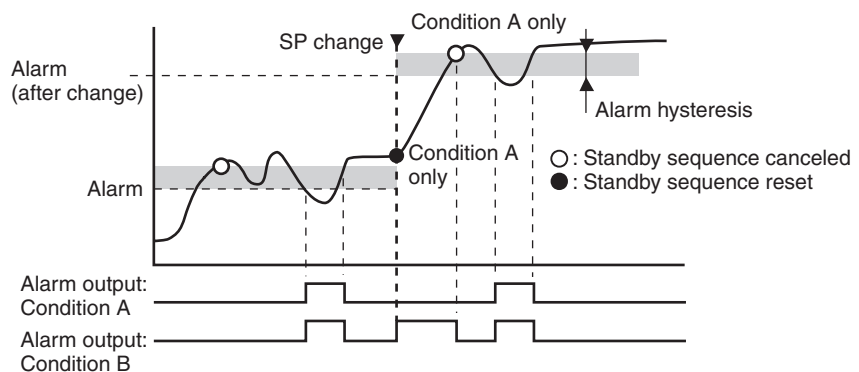

Setting range	Default
R: Condition A, b: Condition B	R



■ **Related Parameters**

Alarm 1 to 3 type (initial setting level): Page 152 to 154
 Alarm 1 to 3 latch (advanced function setting level): Page 167

RL IN

Alarm 1 Open in Alarm

Alarm 1 must be assigned.



Function

- This parameter sets the output status for alarm 1.
- When “close in alarm” is set, the status of the alarm output function will be output as is. When “open in alarm” is set, the status of the alarm output function will be reversed before being output. The following table shows the relationship between alarm output functions, alarm output and output LCDs.
- When “open in alarm” is set, the “open in alarm” status is also applied to heater burnout and HS alarm outputs, and to input error outputs.

	Alarm output operation	Alarm output	Output LCDs
Close in alarm	ON	ON	Lit
	OFF	OFF	Not lit
Open in alarm	ON	OFF	Lit
	OFF	ON	Not lit



Setting

Setting range	Default
$N-\bar{a}$: Close in alarm, $N-L$: Open in alarm	$N-\bar{a}$



■ **Related Parameters**

Alarm value 1: Page 124, Alarm value upper limit 1, Alarm value lower limit 1: Page 126 (operation level)
 Alarm 1 type (initial setting level): Page 152
 Standby sequence reset: Page 161, Alarm 1 hysteresis: Page 163, Alarm 1 latch: Page 167 (advanced function setting level)

RL 2N
RL 3N

Alarm 2 Open in Alarm
Alarm 3 Open in Alarm

Alarm 2 must be assigned.
 Alarm 3 must be assigned.



Function

- These parameters set the output status for alarm 2 and alarm 3 settings.
- When “close in alarm” is set, the status of the alarm output function will be output as is. When “open in alarm” is set, the status of the alarm output function will be reversed before being output. The following table shows the relationship between alarm output functions, alarm output and output LCDs.

	Alarm output operation	Alarm output	Output LCDs
Close in alarm	ON	ON	Lit
	OFF	OFF	Not lit
Open in alarm	ON	OFF	Lit
	OFF	ON	Not lit



Setting

Setting range	Default
$N-\bar{a}$: Close in alarm, $N-L$: Open in alarm	$N-\bar{a}$



■ **Related Parameters**

Alarm value 2 and 3: Page 125, Alarm value upper limit 2 and 3, Alarm value lower limit 2 and 3: Page 126 to 127 (operation level)
 Alarm 2 to 3 type (initial setting level): Page 154
 Alarm 2 and 3 hysteresis: Page 163, Standby sequence reset: Page 161, Alarm 2 and 3 latch: Page 167 (advanced function setting level)

RLH1

Alarm 1 Hysteresis

Alarm 1 must be assigned, and the alarm 1 type must not be 0 or 12.

RLH2

Alarm 2 Hysteresis

Alarm 2 must be assigned, and the alarm 2 type must not be 0.

RLH3

Alarm 3 Hysteresis

Alarm 3 must be assigned, and the alarm 3 type must not be 0.



Function

- These parameters set alarm 1, 2, and 3 hysteresis.



Setting

Models	Setting range	Unit	Default
Controllers with Thermocouple/Resistance Thermometer Multi-inputs	0.1 to 999.9	°C or °F (See note.)	0.2
Controllers with Analog Inputs	0.01 to 99.99	%FS	0.02

Note Set “none” as the unit for Controllers with Analog Inputs.



■ **Related Parameters**

Alarm value 1 to 3: Page 124 to 125, Alarm value upper limit 1 to 3: Page 126 to 127, Alarm value lower limit 1 to 3: Page 126 to 127 (operation level)
 Alarm 1 to 3 type (initial setting level): Page 152 to 154
 Standby sequence reset: Page 161, Alarm 1 to 3 open in alarm: Page 162, Alarm 1 to 3 latch: Page 167 (advanced function setting level)

HbU

HB ON/OFF

Heater burnout and HS alarms must be supported.
 Alarm 1 must be assigned.



Function

- Set to use the heater burnout alarm.



Setting

Setting range	Default
ON: Enabled, OFF: Disabled	ON

HbL

Heater Burnout Latch

Heater burnout and HS alarms must be supported.
Alarm 1 must be assigned.
The “heater burnout detection” parameter must be set to ON.



Function

- When this parameter is set to ON, the heater burnout alarm is held until either of the following conditions is satisfied.
 - a Heater burnout detection is set to 0.0 A.
 - b The power is turned OFF then back ON again (i.e., power is reset).
- Output is turned OFF when switching to the initial setting level, communications setting level, advanced function setting level, or calibration level.



Setting

Setting range	Default
$\bar{0}N$: Enabled, $\bar{0}FF$: Disabled	$\bar{0}FF$

■ **Related Parameter**

HB ON/OFF (advanced function setting level): Page 163



See

HbH

Heater Burnout Hysteresis

The “heater burnout” parameter must be set to ON.
The “heater burnout latch” parameter must be set to OFF.
Heater burnout and HS alarms must be supported.
Alarm 1 must be assigned.



Function

- This parameter sets hysteresis for heater burnout detection.



Setting

Setting range	Unit	Default
0.1 to 50.0	A	0.1

■ **Related Parameter**

HB ON/OFF (advanced function setting level): Page 163



See

5t-b

ST Stable Range

ST must be ON and temperature input, standard control, 2-PID control must be set.



Function

- The setting of this parameter determines when ST operates. This parameter cannot be used when ST is set to OFF.



Setting

Setting range	Unit	Default
0.1 to 999.9	°C or °F	15.0

■ **Related Parameters**

Input type: Page 146, PID ON/OFF: Page 149, ST: Page 150 (initial setting level)



ALFA

α

ST must be OFF and 2-PID control must be set.



Function

- Normally, use the default for this parameter.
- This parameter sets the 2-PID control α constant.



Setting

Setting range	Unit	Default
0.00 to 1.00	None	0.65

■ **Related Parameters**

PID ON/OFF: Page 149, ST: Page 150 (initial setting level)



̄NF

Input Digital Filter



Function

- This parameter sets the time constant for the input digital filter. The following diagram shows the effect on data after passing through the digital filter:

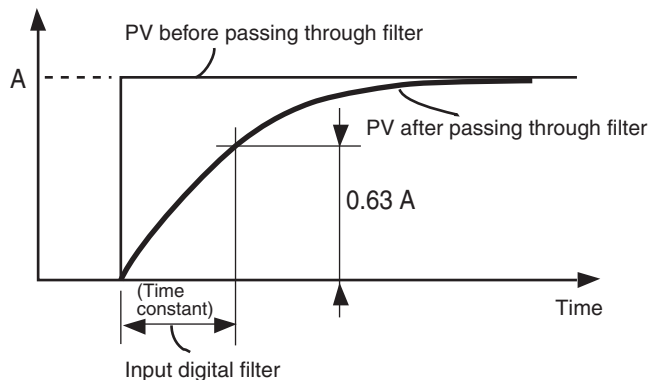

Setting

Setting range	Unit	Default
0.0 to 999.9	Second	0.0

PvRd

Additional PV Display



Function

This parameter adds a display at the beginning of the operation level for the process value (PV). If there is no need to display the set point, use this to display only the present temperature.

Set to ON to display, and OFF to not display.



Setting

Setting range	Default
$\bar{a}N$: Displayed, $\bar{a}FF$: Not displayed	$\bar{a}FF$

̄-dP

MV Display



Function

This parameter is used to display the manipulated variable (MV).

The manipulated variable is displayed when the “MV monitor (heating) and (cooling)” parameters are set to ON, and not displayed when these parameters are set to OFF.



Setting

Setting range	Default
$\bar{a}N$: Displayed, $\bar{a}FF$: Not displayed	$\bar{a}FF$

■ **Related Parameters**

MV monitor (heating): Page 127, MV monitor (cooling): Page 128 (operation level)



See

REL Automatic Display Return Time



- In the operation level or adjustment level, the display automatically returns to the PV/SP if there are no key operations for the time set for this parameter.
- The automatic display return time is disabled when the parameter is set to OFF. (In that case, the display will not be automatically switched.)



Setting range	Unit	Default
OFF, 1 to 99	Second	OFF

R1LE Alarm 1 Latch

Alarm 1 must be assigned, and the alarm 1 type must not be 0.

R2LE Alarm 2 Latch

Alarm 2 must be assigned, and the alarm 2 type must not be 0.

R3LE Alarm 3 Latch

Alarm 3 must be assigned, and the alarm 3 type must not be 0.



- When a parameter is set to ON, once the alarm function has turned ON it is held until the power is turned OFF. The latch can be canceled, however, by switching to the initial setting level, communications setting level, advanced function setting level, or calibration level.
- If alarm outputs are set to “close in alarm,” the outputs are kept closed. If they are set to “open in alarm,” they are kept open.



Setting range	Default
ON: Enabled, OFF: Disabled	OFF



■ **Related Parameters**

Alarm value 1 to 3: Page 124 to 125, Alarm value upper limit 1 to 3: Page 126 to 127, Alarm value lower limit 1 to 3: Page 126 to 127 (operation level)
 Alarm 1 to 3 type (initial setting level): Page 152 to 154
 Standby sequence reset: Page 161, Alarm 1 to 3 open in alarm: Page 162, Alarm 1 to 3 hysteresis: Page 163 (advanced function setting level)

PRLt **Move to Protect Level Time**



Function

- This parameter sets the key pressing time required to move to the protect level from the operation level or the adjustment level.



Setting

Setting range	Unit	Default
1 to 30	Second	3



■ **Related Parameters**

Operation/adjustment protect, initial setting/communications protect, setting change protect (protect level): Page 116

SE \bar{R} \bar{O} **Input Error Output**

Alarm 1 must be assigned.



Function

- When this parameter is set to ON, alarm 1 output turns ON for input errors.
The alarm 1 operation indicator will not light.
- The alarm 1 output is an OR output of alarm 1, HBA burnout/HS alarm, and input error.
- Output is turned OFF when switching to the initial setting level, communications setting level, advanced function setting level, or calibration level.



Setting

Setting range	Default
$\bar{O}N$: Enabled, $\bar{O}FF$: Disabled	$\bar{O}FF$

EJC **Cold Junction Compensation Method**

Input type must be thermocouple or infrared temperature sensor



Function

- Specifies whether cold junction compensation is to be performed internally by the Controller or to be performed externally when the input type setting is to between 5 and 22.
- The cold junction compensation external setting is enabled when the temperature difference is measured using two thermocouples or two ES1B Sensors.



Setting

Setting range	Default
$\bar{O}N$: Internally, $\bar{O}FF$: Externally	$\bar{O}N$



■ **Related Parameter**

Input type (initial setting level): Page 146

RLRV

MB Command Logic Switching

Communications must be supported. CompoWay/F must be selected as the protocol.



Function



Setting

- This parameter switches the logic of the MB command (communications writing switch) for the SYSWAY communications protocol
- The MB command (communications writing switch) is the equivalent of the MB command (remote/local switch) of the E5□J.
- The setting indicated by the shaded area is the default (same logic as E5□J).

Set value	Text data of MB command	
	0000	0001
OFF	Communications writing enabled (remote mode selection)	Communications writing disabled (local mode selection)
ON	Communications writing disabled (local mode selection)	Communications writing enabled (remote mode selection)

(Terms in parentheses () are the terms used on the E5□J.)



■ **Related Parameters**

Communications writing (adjustment level): Page 131

Protocol setting (communications setting level): Page 182

EaLR

PV Change Color



Function

Use the PV color change function to change the color of the PV display (No. 1 display).

There are three display colors, orange, red, and green, and you can select from the following three modes and eight types.

- Constant: This mode displays orange, red, or green all the time.
- Linked to Alarm 1: This mode switches the PV display color from red to green when alarm 1 turns ON or from green to red when alarm 1 turns ON.
- Linked to PV stable band: This mode switches the PV display color between red outside the PV stable band and green within PV stable band, or between green outside the PV stable band and red within PV stable band. Set the PV stable band in the “PV stable band” parameter in the advanced function setting level.
- The default is *REd* (red).

The following table shows the display functions that can be set using the PV color change function.



Setting

Mode	Setting	Function	PV change color	Application example
Constant	<i>ORg</i>	Orange	Constant: Orange	To match the display color with other Controller models
	<i>REd</i>	Red	Constant: Red	To match the display color with other Controller models
	<i>GRN</i>	Green	Constant: Green	To match the display color with other Controller models

Mode	Setting	Function	PV change color		Application example	
Linked to alarm 1						
			ALM1 not lit	ALM1 lit	Application example	
	$R-\bar{G}$	Red to Green	Red	Green	To display the PV reached signal	
	$\bar{G}-R$	Green to Red	Green	Red	To display error signals	
Linked to PV stable band						
			Low	PV stable band	High	Application example
	$R-\bar{G},R$	Red to Green to Red	Red	Green	Red	To display stable status
	$\bar{G}-\bar{o},R$	Green to Orange to Red	Green	Orange	Red	To display stable status
	$\bar{o}-\bar{G},R$	Orange to Green to Red	Orange	Green	Red	To display stable status

■ **Related Parameters**



PV stable band (advanced function setting level): Page 170

PV -b

PV Stable Band



Function

This parameter sets the PV stable band width within which the PV display color is changed.

- When the mode to link to the PV stable band is selected with the “PV change color” parameter, the PV display color will change according to whether the present value (PV) is lower than, within, or higher than the PV stable band, as shown in the following figure.
- There is a fixed hysteresis of 0.2 (°C or °F).

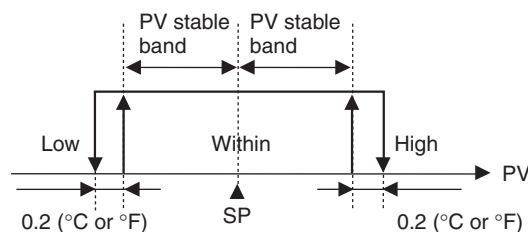

When analog inputs are used: 0.02 (%FS)



Setting

Models	Setting range	Unit	Default
Controllers with Thermocouple/Resistance Thermometer Multi-inputs	0.1 to 999.9	°C or °F (See note.)	5.0
Controllers with Analog Inputs	0.01 to 99.99	%FS	5.00

Note Set “none” as the unit for Controllers with Analog Inputs.



■ **Related Parameter**

PV change color (advanced function setting level): Page 169

R1ōN

Alarm 1 ON Delay

Alarm 1 must be assigned, and the alarm 1 type must not be 0 or 12.

R2ōN

Alarm 2 ON Delay

Alarm 2 must be assigned, and the alarm 2 type must not be 0.

R3ōN

Alarm 3 ON Delay

Alarm 3 must be assigned, and the alarm 3 type must not be 0.

Alarm 1, 2, or 3 outputs are prevented from turning ON until after the delay times set in these parameters have elapsed.

- Set the time for which the ON delay is to be enabled.
- To disable the ON delay, set 0.



Function



Setting

Setting range	Unit	Default
0 to 999	Second	0



■ **Related Parameters**

Alarm 1 to 3 type (initial setting level): Page 152 to 154

R1\bar{o}F	Alarm 1 OFF Delay	Alarm 1 must be assigned, and the alarm 1 type must not be 0 or 12.
R2\bar{o}F	Alarm 2 OFF Delay	Alarm 2 must be assigned, and the alarm 2 type must not be 0.
R3\bar{o}F	Alarm 3 OFF Delay	Alarm 3 must be assigned, and the alarm 3 type must not be 0.

Alarm 1, 2, or 3 outputs are prevented from turning OFF until after the delay times set in these parameters have elapsed.

- Set the time for which the OFF delay is to be enabled.
- To disable the OFF delay, set 0.



Function



Setting

Setting range	Unit	Default
0 to 999	Second	0



■ **Related Parameters**

Alarm 1 to 3 type (initial setting level): Page 152 to 154

$\bar{c}NSP$	Input Shift Type	The input type must be thermocouple or resistance thermometer.
--------------------------------	-------------------------	--

This parameter sets the shift method for thermocouple or resistance thermometer inputs.

- When the input type is thermocouple or resistance thermometer, set either a 1-point shift or a 2-point shift.



Function



Setting

Setting range	Default
$\bar{c}NS1$: 1-point shift, $\bar{c}NS2$: 2-point shift	$\bar{c}NS1$



■ **Related Parameters**

Temperature input shift, Upper-limit temperature input shift value, Lower-limit temperature input shift value (adjustment level): Page 136

Input type (initial setting level): Page 146

MVSE

MV at Stop and Error Addition

The control must be set to 2-PID control.

This parameter sets whether or not the “MV at stop” and “MV at PV error” parameters are to be displayed.

- Set whether or not the “MV at stop” and “MV at PV error” parameters are to be displayed.



Function



Setting

Setting range	Default
$\bar{a}N$: Displayed, $\bar{a}FF$: Not displayed	$\bar{a}FF$

■ **Related Parameters**

MV at stop, MV at PV error (adjustment level): Page 142



RMRd

Auto/Manual Select Addition

The control must be set to 2-PID control.

This parameter sets whether the “auto/manual switch” parameter is to be displayed.

- Set whether the “auto/manual switch” parameter is to be displayed.



Function



Setting

Setting range	Default
$\bar{a}N$: Displayed, $\bar{a}FF$: Not displayed	$\bar{a}FF$

■ **Related Parameter**

Auto/manual switch (operation level): Page 120



RL

RT

The control must be set to 2-PID control.
The input type must be set to temperature input.



Function

This parameter executes robust tuning (RT).

- When AT or ST is executed with RT selected, PID constants are automatically set which make it hard for control performance to degenerate even when control object characteristics are changed.
- Even when hunting occurs for PID constants when AT or ST is executed in normal mode, it is less likely to occur when AT or ST is executed in RT mode.



Setting

Setting range	Default
$\bar{a}N$: RT function OFF, $\bar{a}FF$: RT function ON	$\bar{a}FF$



See

■ **Related Parameters**

AT execute/cancel: Page 131, Proportional band, Integral time, Derivative time: Page 138 (adjustment level)

PID ON/OFF: Page 149, ST: Page 150 (initial setting level)

HSU

HS Alarm Use

Heater burnout and HS alarms must be supported.
Alarm 1 must be assigned.



Function

- Set this parameter to use HS alarms.



Setting

Setting range	Default
$\bar{a}N$: Enabled, $\bar{a}FF$: Disabled	$\bar{a}N$

H5L

HS Alarm Latch

Heater burnout and HS alarms must be supported.
Alarm 1 must be assigned.
The “HS alarm” parameter must be set to ON.



Function

- When this parameter is set to ON, the HS alarm is held until either of the following conditions is satisfied.
 - a The HS alarm current is set to 50.0 A.
 - b The power is turned OFF then back ON again (i.e., power is reset).
- Output is turned OFF when switching to the initial setting level, communications setting level, advanced function setting level, or calibration level.



Setting

Setting range	Default
$\bar{0}N$: Enabled, $\bar{0}FF$: Disabled	$\bar{0}FF$

■ **Related Parameter**

HS alarm use (advanced function setting level): Page 174



H5H

HS Alarm Hysteresis

Heater burnout and HS alarms must be supported.
Alarm 1 must be assigned.
The “HS alarm” parameter must be set to ON.
The “HS alarm latch” must be set to OFF.



Function

- This parameter sets the hysteresis for HS alarms.



Setting

Setting range	Unit	Default
0.1 to 50.0	A	0.1

■ **Related Parameter**

HS alarm use (advanced function setting level): Page 174



LbA

LBA Detection Time

Alarm 1 must be assigned.
The alarm type must be set to 12 (LBA).



Function

This parameter enables or disables the LBA function and sets the detection time interval.

- Set the time interval for detecting loop burnouts.
- To disable the LBA function, set 0.



Setting

Setting range	Unit	Default
0 to 9999	Second	0



■ **Related Parameters**

Alarm 1 type (initial setting level): Page 152

LBA level: Page 176, LBA band: Page 177 (advanced function setting level)

LbAL

LBA Level

Alarm 1 must be assigned.
The alarm type must be set to 12 (LBA).
The LBA detection time must not be 0.



Function

- This parameter sets the LBA level.
- If the deviation between the SP and PV exceeds the LBA level, a loop burnout is detected.



Setting

Models	Setting range	Unit	Default
Controllers with Thermocouple/Resistance Thermometer Multi-inputs	0.1 to 999.9	°C or °F (See note.)	8.0
Controllers with Analog Inputs	0.01 to 99.99	%FS	10.00

Note Set “none” as the unit for Controllers with Analog Inputs.



■ **Related Parameters**

Process value/set point (operation level): Page 120

Alarm 1 type (initial setting level): Page 152

LBA detection time: Page 176, LBA band: Page 177 (advanced function setting level)

LbAb

LBA Band

Alarm 1 must be assigned.
The alarm type must be set to 12 (LBA).
The LBA detection time must not be 0.



- This parameter sets the LBA band.
- If a control deviation greater than the LBA band is not reduced when the LBA level is exceeded, an loop burnout is detected.

Models	Setting range	Unit	Default
Controllers with Thermocouple/Resistance Thermometer Multi-inputs	0.0 to 999.9	°C or °F (See note.)	3.0
Controllers with Analog Inputs	0.00 to 99.99	%FS	0.20

Note Set “none” as the unit for Controllers with Analog Inputs.



■ **Related Parameters**

Process value/set point (operation level): Page 120

Alarm 1 type (initial setting level): Page 152

LBA detection time, LBA level (advanced function setting level): Page 176

oUt 1

Control Output 1 Assignment

The transfer output type must be set to OFF when the control output is a current output.



- This parameter sets the function to be assigned to control output 1.

Setting range	Default
nāNE: No function is assigned to control output 1.	ā
ā: Heating control output is output.	
Ē - ā: Cooling control output is output. (See note 1.)	
RLM1: Alarm 1 is output. (See note 2.)	
RLM2: Alarm 2 is output. (See note 2.)	
RLM3: Alarm 3 is output. (See note 2.)	
P.ENd: Program end is output. (See notes 2 and 3.)	

- Note**
- (1) If Ē - ā is assigned for standard control, a value equivalent to 0% is output.
 - (2) Can be selected for relay and voltage outputs only.
 - (3) Can be selected only when the program pattern is not set to OFF.



■ **Related Parameters**

Standard or heating/cooling: Page 150, Program pattern: Page 151, Transfer output type: Page 155 (initial setting level)

OUT2

Control Output 2 Assignment

Control output 2 must be assigned.



Function



Setting

- This parameter sets the function to be assigned to control output 2.

Setting range	Default
<i>NONE</i> : No function is assigned to control output 2.	<i>NONE</i> (See note 3.)
\bar{a} : Heating control output is output.	
\bar{c} - \bar{a} : Cooling control output is output. (See note 1.)	
<i>RLM1</i> : Alarm 1 is output.	
<i>RLM2</i> : Alarm 2 is output.	
<i>RLM3</i> : Alarm 3 is output.	
<i>P.END</i> : Program end is output. (See note 2.)	

- Note**
- (1) If \bar{c} - \bar{a} is assigned for standard control, a value equivalent to 0% will be output.
 - (2) Can be selected only when the program pattern is not set to OFF.
 - (3) If the “standard or heating/cooling” parameter is set to heating/cooling control, control automatically switches to \bar{c} - \bar{a} .



■ **Related Parameters**

Standard or heating/cooling: Page 150, Program pattern: Page 151, (initial setting level)

RLM1

Alarm 1 Assignment

Alarm output 1 must be assigned.



Function



Setting

- This parameter sets the function to be assigned to alarm output 1.

Setting range	Default
<i>NONE</i> : No function is assigned to alarm output 1.	<i>RLM1</i> (See note 3.)
\bar{a} : Heating control output is output.	
\bar{c} - \bar{a} : Cooling control output is output. (See note 1.)	
<i>RLM1</i> : Alarm 1 is output.	
<i>RLM2</i> : Alarm 2 is output.	
<i>RLM3</i> : Alarm 3 is output.	
<i>P.END</i> : Program end is output. (See note 2.)	

- Note**
- (1) If \bar{c} - \bar{a} is assigned for standard control, a value equivalent to 0% will be output.
 - (2) Can be selected only when the program pattern is not set to OFF.
 - (3) If a setting is changed when the “program pattern” parameter is not set to OFF, control automatically switches to *P.END*.



■ **Related Parameter**

Program pattern (initial setting level): Page 151

RLM2

Alarm 2 Assignment

Alarm output 2 must be assigned.



Function



Setting

- This parameter sets the function to be assigned to alarm output 2.

Setting range	Default
<i>NONE</i> : No function is assigned to alarm output 2.	<i>RLM2</i> (See note 3.)
\bar{a} : Heating control output is output.	
$\bar{c} - \bar{a}$: Cooling control output is output. (See note 1.)	
<i>RLM1</i> : Alarm 1 is output.	
<i>RLM2</i> : Alarm 2 is output.	
<i>RLM3</i> : Alarm 3 is output.	
<i>P.END</i> : Program end is output. (See note 2.)	

- Note**
- (1) If $\bar{c} - \bar{a}$ is assigned for standard control, a value equivalent to 0% will be output.
 - (2) Can be selected only when the program pattern is not set to OFF.
 - (3) If the “standard or heating/cooling” parameter is set to heating/cooling control when there is no control output 2 (E5CN/CN-U), control automatically switches to $\bar{c} - \bar{a}$.



■ **Related Parameters**

Standard or heating/cooling: Page 150, Program pattern: Page 151, (initial setting level)

RLM3

Alarm 3 Assignment

Alarm output 3 must be assigned (E5AN and E5EN only).



- This parameter sets the function to be assigned to alarm output 3.

Setting range	Default
$\bar{N}\bar{a}\bar{N}\bar{E}$: No function is assigned to alarm output 3.	$RLM3$ (See note 3.)
\bar{a} : Heating control output is output.	
$\bar{L}-\bar{a}$: Cooling control output is output. (See note 1.)	
$RLM1$: Alarm 1 is output.	
$RLM2$: Alarm 2 is output.	
$RLM3$: Alarm 3 is output.	
$P.END$: Program end is output. (See note 2.)	

- Note**
- (1) If $\bar{L}-\bar{a}$ is assigned for standard control, a value equivalent to 0% will be output.
 - (2) Can be selected only when the program pattern is not set to OFF.
 - (3) If the “standard or heating/cooling” parameter is set to heating/cooling control when there is no control output 2 (E5AN/EN), control automatically switches to $\bar{L}-\bar{a}$.



■ **Related Parameters**

Standard or heating/cooling: Page 150, Program pattern: Page 151, (initial setting level)

[SEL

Character Select



- This parameter switches the characters to be displayed. The following two types of characters can be displayed.
11-segment display
7-segment display

Setting range	Default
$\bar{a}\bar{N}$: 11-segment display, $\bar{a}\bar{F}\bar{F}$: 7-segment display	$\bar{a}\bar{N}$

When set to $\bar{a}\bar{N}$, an 11-segment display is used.

E-U

Soak Time Unit

The “program pattern” parameter must not be set to OFF.



- Set the soak time unit for the simple program function.



Setting range	Default
M: Minutes, H: Hours	M



■ **Related Parameters**

- Program start, Soak time remain (operation level): Page 123
- Soak time, Wait band (adjustment level): Page 141
- Program pattern (initial setting level): Page 151

RLSP

Alarm SP Selection

Alarm 1, 2, and 3 functions must be assigned.
The “SP ramp set value” and “ST” parameters must not be set to OFF.
The alarm type must set to a deviation alarm.

This parameter sets whether the set point that triggers a deviation alarm during SP ramp operation is to be the ramp SP or target SP.



- Set whether the set point that triggers a deviation alarm is the ramp SP or target SP.



Setting range	Default
SP-M: Ramp SP, SP: SP	SP-M



■ **Related Parameters**

- SP ramp set value (adjustment level): Page 143
- ST (initial setting level): Page 150

EMOV

Move to Calibration Level

Initial setting/communications protect must be 0.

This parameter sets the password to move to the calibration level.



- Set the password to move to the calibration level. The password is 1201.
- Move to the calibration level either by pressing the key or key or by waiting for two seconds to elapse.



■ **Related Parameter**

- Initial setting/communications protect (protect level): Page 116

5-8 Communications Setting Level

<i>PSEL</i>	Protocol Setting	Communications must be supported.
<i>U-Nō</i>	Communications Unit No.	
<i>bPS</i>	Communications Baud Rate	
<i>LEN</i>	Communications Data Length	CompoWay/F must be selected as the protocol.
<i>Sb̄t</i>	Communications Stop Bits	CompoWay/F must be selected as the protocol.
<i>PR̄Y</i>	Communications Parity	
<i>SdWt</i>	Send Data Wait Time	



- Each parameter is enabled when the power is reset.
- Match the communications specifications of the E5□N and the host computer. If multiple devices are connected, ensure that the communications specifications for all devices in the system (except the Communications unit number) are the same.



Item	Symbol	Set values	Settings	Default
Protocol setting	<i>PSEL</i>	<i>ENF, Mōd</i>	CompoWay/F (SYSWAY), Modbus	<i>ENF</i>
Communications Unit No.	<i>U-Nō</i>	0 to 99	0 to 99	<i>1</i>
Communications baud rate	<i>bPS</i>	1.2, 2.4, 4.8, 9.6, 19.2, or 38.4 (kbit/s)	1.2, 2.4, 4.8, 9.6, 19.2, or 38.4 (kbit/s)	<i>9.6</i>
Communications data length	<i>LEN</i>	7, 8 (bit)	7, 8 (bit)	<i>7</i>
Stop bits	<i>Sb̄t</i>	1, 2	1, 2	<i>2</i>
Communications parity	<i>PR̄Y</i>	<i>NōNE, EVEN, ōdd</i>	None, Even, Odd	<i>EVEN</i>
Send data wait time	<i>SdWt</i>	0 to 99	0 to 99 (ms)	<i>20</i>

■ **Related Parameter**

Communications writing (adjustment level): Page 131



SECTION 6 CALIBRATION

This section describes how the user can calibrate the E5CN and E5CN-U Digital Temperature Controllers.

6-1	Parameter Structure	184
6-2	User Calibration	186
6-2-1	Calibrating Inputs	186
6-2-2	Registering Calibration Data	186
6-3	Thermocouple Calibration (Thermocouple/Resistance Thermometer Input)	186
6-3-1	Preparations	187
6-4	Platinum Resistance Thermometer Calibration (Thermocouple/Resistance Thermometer Input)	190
6-5	Analog Input Calibration (Thermocouple/Resistance Thermometer Input)	192
6-6	Calibrating Analog Input (Analog Input)	193
6-6-1	Calibrating a Current Input	193
6-6-2	Calibrating a Voltage Input	194
6-7	Checking Indication Accuracy	195
6-7-1	Thermocouple or Infrared Temperature Sensor	195
6-7-2	Platinum Resistance Thermometer	196
6-7-3	Analog Input	196

6-2 User Calibration

The E5CN/CN-U/AN/EN is correctly calibrated before it is shipped from the factory, and normally need not be calibrated by the user.

If, however, it must be calibrated by the user, use the parameters for calibrating temperature input and analog input. OMRON, however, cannot ensure the results of calibration by the user. Also, calibration data is overwritten with the latest calibration results. The default calibration settings cannot be restored after user calibration. Perform user calibration with care.

6-2-1 Calibrating Inputs

The input type selected in the parameter is used for calibration. The input types are as follows:

Controllers with Thermocouple/Resistance Thermometer Multi-inputs

- Thermocouple: 14 types
- Infrared temperature sensor: 4 types
- Analog input: 1 type
- Platinum resistance thermometer: 5 types

Controllers with Analog Inputs

- Current input: 2 types
- Voltage input: 3 types

6-2-2 Registering Calibration Data

The new calibration data for each item is temporarily registered. It can be officially registered as calibration data only when all items have been calibrated to new values. Therefore, be sure to temporarily register all items when you perform the calibration. When the data is registered, it is also recorded that user calibration has been performed.

Prepare separate measuring devices and equipment for calibration. For details on how to handle measuring devices and equipment, refer to the respective instruction manuals.

6-3 Thermocouple Calibration (Thermocouple/Resistance Thermometer Input)

- Calibrate according to the type of thermocouple: thermocouple 1 group (input types 5, 7, 11, 12, 15) and thermocouple 2 group (input types 6, 8, 9, 10, 13, 14, 16, 17, 18, 19, 20, 21, 22).
- When calibrating, do not cover the bottom of the Controller. Also, do not touch input terminals/pins (terminals 4 and 5 on the E5CN, pins 1 and 2 on the E5CN-U, and pins 17 and 18 on the E5AN/EN) or compensating conductors.

6-3-1 Preparations

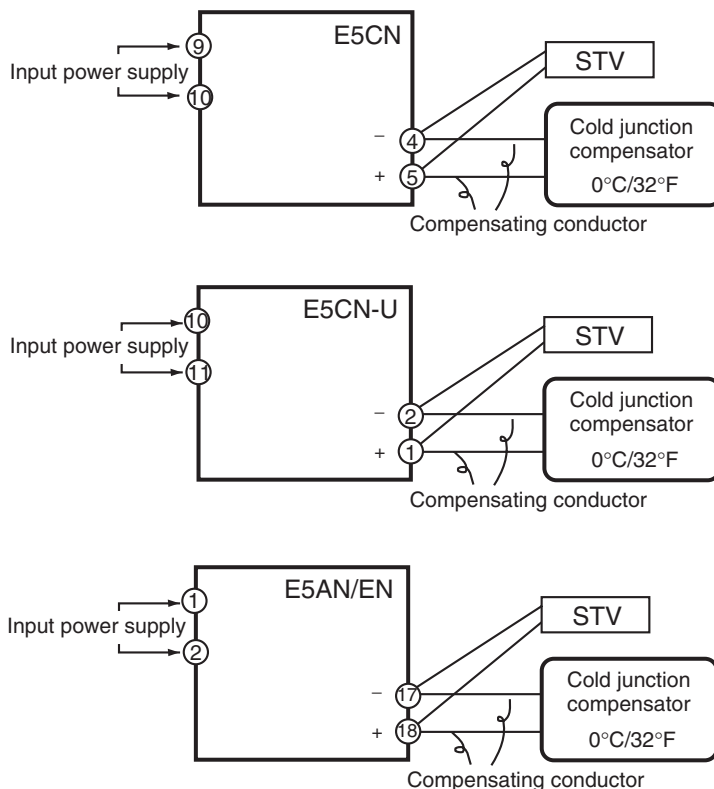

- Set the cold junction compensator designed for compensation of internal thermocouples to 0°C. Make sure that internal thermocouples are disabled (i.e., that tips are open).
- In the above figure, STV indicates a standard DC current/voltage source.
- Use the compensating conductor designed for the selected thermocouple. When thermocouples R, S, E, or B or an infrared temperature sensor is used, the cold junction compensator and the compensating conductor can be substituted with the cold junction compensator and the compensating conductor for thermocouple K.

■ Connecting the Cold Junction Compensator

Correct process values cannot be obtained if you touch the contact ends of the compensating conductor during calibration of a thermocouple. Accordingly, short-circuit (enable) or open (disable) the tip of the thermocouple inside the cold junction compensator as shown in the figure below to create a contact or non-contact state for the cold junction compensator.

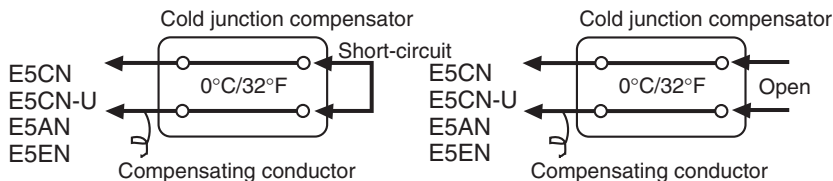

In this example, calibration is shown for a Controller with a Thermocouple/Resistance Thermometer Multi-input, with thermocouple/infrared temperature sensor set as the input type.

- 1,2,3...**
1. Connect the power supply.
 2. Connect a standard DC current/voltage source (STV), precision digital multimeter (DMM), and contact junction compensator (e.g., a zero controller as in the figure) to the thermocouple input terminals, as shown in the figure below.

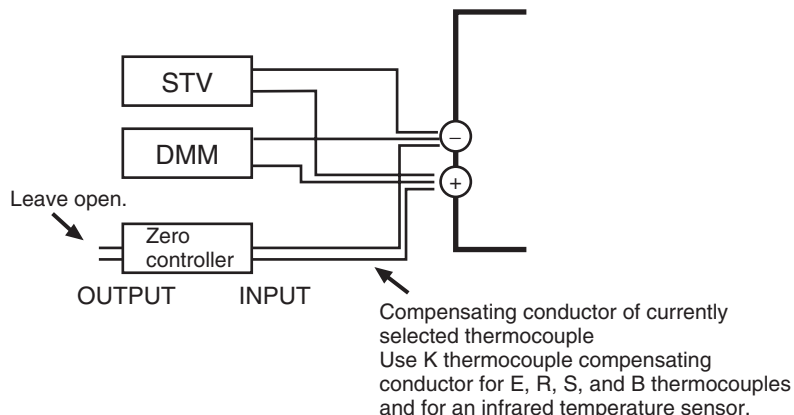

3. Turn the power ON.
4. Move to the calibration level.
This starts the 30-minute aging timer. This timer provides an approximate timer for aging. After 30 minutes have elapsed, the No. 2 display changes to 0. You can advance to the next step in this procedure even if 0 is not displayed.

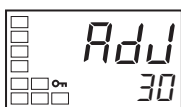

Input types 5, 7, 11, 12, 15:

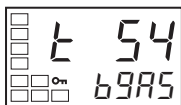

Input types 6, 8, 9, 10, 13, 14, 16, 17, 18, 19, 20, 21, 22:

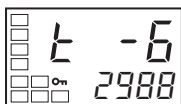
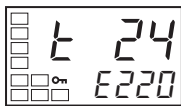

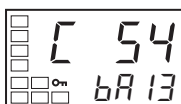

Input types 6, 8, 9, 10, 13, 14, 16, 17, 18, 19, 20, 21, and 22 only:

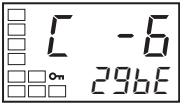

5. When the key is pressed, the status changes as shown to the left. The No. 2 display at this time shows the currently entered count value in hexadecimal. Set the STV as follows:
 - Input types 5, 7, 11, 12, 15 : Set to 54 mV.
 - Input types 6, 8, 9, 10, 13, 14, 16, 17, 18, 19, 20, 21, 22: Set to 24 mV.
 Allow the count value on the No. 2 display to fully stabilize, then press the key to temporarily register the calibration settings. If this count value is outside of the specified range, the No. 2 display will flash and the count value will not be temporarily registered.
6. When the key is pressed, the status changes as shown to the left. Set the STV to -6 mV. Allow the count value on the No. 2 display to fully stabilize, then press the key to temporarily register the calibration settings. If this count value is outside of the specified range, the No. 2 display will flash and the count value will not be temporarily registered.
7. Press the key. The display changes as shown on the left for input types 6, 8, 9, 10, 13, 14, 16, 17, 18, 19, 20, 21, and 22. Set the STV to 54 mV. Allow the count value on the No. 2 display to fully stabilize, then press the key to temporarily register the calibration settings. If this count value is outside of the specified range, the No. 2 display will flash and the count value will not be temporarily registered.

Input types 6, 8, 9, 10, 13, 14, 16, 17, 18, 19, 20, 21, and 22 only:







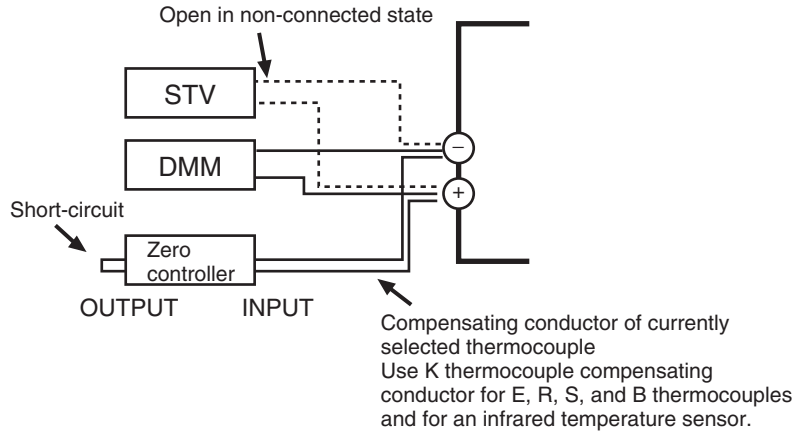

8. Press the  key. The display changes as shown on the left for input types 6, 8, 9, 10, 13, 14, 16, 17, 18, 19, 20, 21, and 22. Set the STV to -6 mV. Allow the count value on the No. 2 display to fully stabilize, then press the  key to temporarily register the calibration settings. If this count value is outside of the specified range, the No. 2 display will flash and the count value will not be temporarily registered.

9. When the  key is pressed, the status changes as shown to the left.

10. Change the wiring as follows:



Disconnect the STV to enable the thermocouple of the cold junction compensator. When doing this, be sure to disconnect the wiring on the STV side.

11. Allow the count value on the No. 2 display to fully stabilize, then press the  key to temporarily register the calibration settings.
12. When the  key is pressed, the status changes as shown to the left. The data to be temporarily registered is not displayed if it is not complete. Press the  key. The No. 2 display changes to $5E5$. Release the key and wait two seconds or press the  key. This stores the temporarily registered calibration data to EEPROM. To cancel the saving of temporarily registered calibration data to EEPROM, press the  key (while $5E5$ is displayed in the No. 2 display) without pressing the  key.
13. The calibration mode is ended by turning the power OFF.

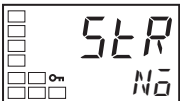

6-4 Platinum Resistance Thermometer Calibration (Thermocouple/Resistance Thermometer Input)

In this example, calibration is shown for Controller with a Thermocouple/Resistance Thermometer Multi-input, with a resistance thermometer set as the input type.

Use connecting wires of the same thickness.

- 1,2,3... 1. Connect the power supply.
2. Connect a precision resistance box (called a “6-dial” in this manual) to the platinum resistance thermometer input terminals, as shown in the following diagram.

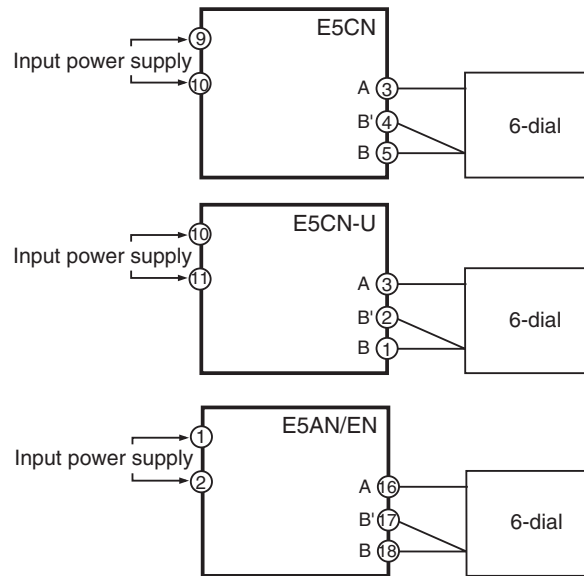

3. Turn the power ON.
4. Move to the calibration level.
This starts the 30-minute aging timer. This timer provides an approximate timer for aging. After 30 minutes have elapsed, the No. 2 display changes to 0. You can advance to the next step in this procedure even if 0 is not displayed.

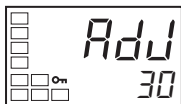

Input type 0:

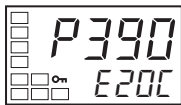

Input types 1, 2, 3, 4:

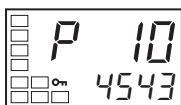
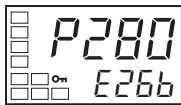

5. Execute calibration for the main input.
Press the key to display the count value for each input type. The No. 2 display at this time shows the currently entered count value in hexadecimal. Set the 6-dial as follows:
 - Input type 0: 390 Ω
 - Input type 1, 2, 3 or 4: 280 Ω
 Allow the count value on the No. 2 display to fully stabilize, then press the key to temporarily register the calibration settings. If this count value is outside of the specified range, the No. 2 display will flash and the count value will not be temporarily registered.
6. When the key is pressed, the status changes as shown to the left. Set the 6-dial to 10 Ω.
Allow the count value on the No. 2 display to fully stabilize, then press the key to temporarily register the calibration settings. If this count value is outside of the specified range, the No. 2 display will flash and the count value will not be temporarily registered.

- Next calibrate the B-B' input.
Change the connections as follows:

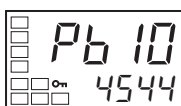
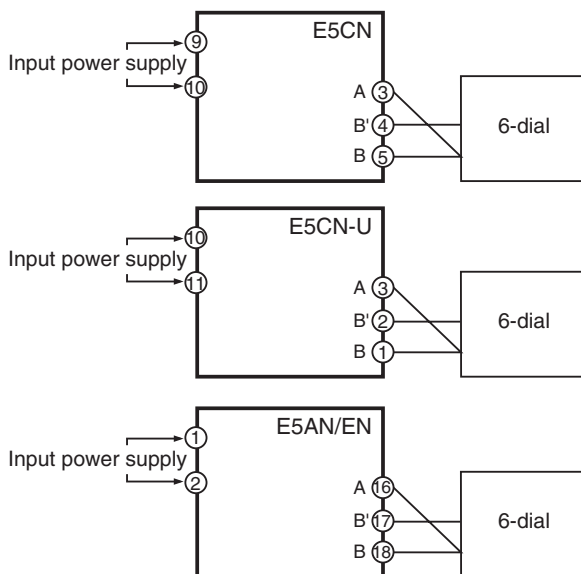

- When the key is pressed, the status changes as shown to the left. Set the 6-dial to 10 Ω.
Allow the count value on the No. 2 display to fully stabilize, then press the key to temporarily register the calibration settings.
If this count value is outside of the specified range, the No. 2 display will flash and the count value will not be temporarily registered.
- When the key is pressed, the status changes as shown to the left. Short-circuit the 6-dial terminals to set 0 Ω.

Note The 6-dial terminals must be short-circuited, because it is otherwise impossible to set 0 Ω for the 6-dial.

Allow the count value on the No. 2 display to fully stabilize, then press the key to temporarily register the calibration settings.
If this count value is outside of the specified range, the No. 2 display will flash and the count value will not be temporarily registered.

- When the key is pressed, the status changes as shown to the left. The data to be temporarily registered is not displayed if it is not complete. Press the key. The No. 2 display changes to 4E5. Release the key and wait two seconds or press the key. This stores the temporarily registered calibration data to EEPROM.
To cancel the saving of temporarily registered calibration data to EEPROM, press the key (while No is displayed in the No. 2 display) without pressing the key.
- The calibration mode is quit by turning the power OFF.

6-5 Analog Input Calibration (Thermocouple/Resistance Thermometer Input)

In this example, calibration is shown for a Controller with a Thermocouple/Resistance Thermometer Multi-input, with an analog input (0 to 50 mV) set as the input type.

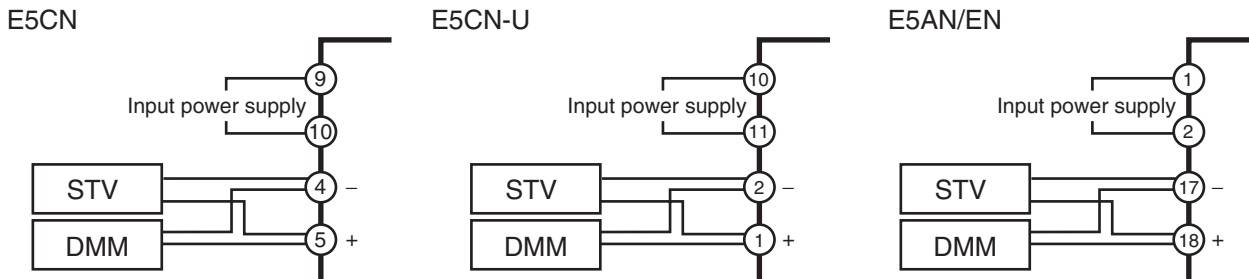

- 1,2,3...**
1. Connect the power supply.
 2. Connect an STV and DMM to the analog input terminals (same as thermocouple inputs), as shown in the figure above.
 3. Turn the power ON.
 4. Move to the calibration level.
This starts the 30-minute aging timer. This timer provides an approximate timer for aging. After 30 minutes have elapsed, the No. 2 display changes to 0. You can advance to the next step in this procedure even if 0 is not displayed.
 5. When the key is pressed, the status changes as shown to the left. The No. 2 display at this time shows the currently entered count value in hexadecimal. Set the STV to 54 mV.
Allow the count value on the No. 2 display to fully stabilize, then press the key to temporarily register the calibration settings.
If this count value is outside of the specified range, the No. 2 display will flash and the count value will not be temporarily registered.
 6. When the key is pressed, the status changes as shown to the left. Set the STV to -6 mV.
Allow the count value on the No. 2 display to fully stabilize, then press the key to temporarily register the calibration settings.
If this count value is outside of the specified range, the No. 2 display will flash and the count value will not be temporarily registered.
 7. When the key is pressed, the status changes as shown to the left. The data to be temporarily registered is not displayed if it is not complete. Press the key. The No. 2 display changes to $4E5$. Release the key and wait two seconds or press the key. This stores the temporarily registered calibration data to EEPROM.
To cancel the saving of temporarily registered calibration data to EEPROM, press the key (while $N\bar{0}$ is displayed in the No. 2 display) without pressing the key.
 8. The calibration mode is ended by turning the power OFF.

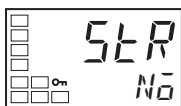
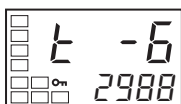
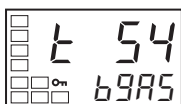
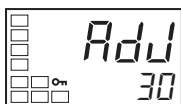

6-6 Calibrating Analog Input (Analog Input)

6-6-1 Calibrating a Current Input

In this example, calibration is shown for a Controller with an Analog Input, with a current input set as the input type.

- 1,2,3... 1. Connect the power supply.
 2. Connect an STV and DMM to the current input terminals, as shown in the following diagram.

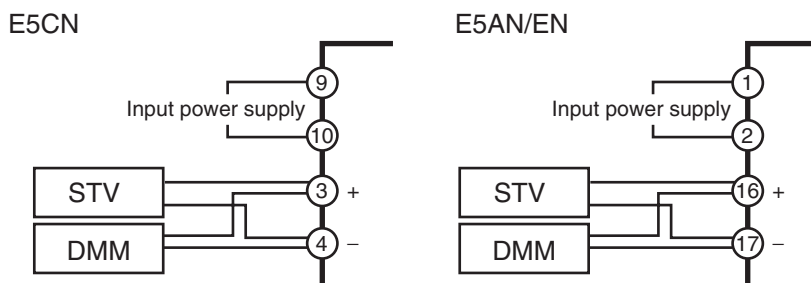

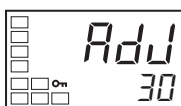

3. Turn the power ON.
 4. Move to the calibration level.
 This starts the 30-minute aging timer. This timer provides an approximate timer for aging. After 30 minutes have elapsed, the No. 2 display changes to 0. You can advance to the next step in this procedure even if 0 is not displayed.



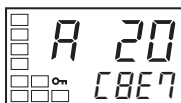

5. When the  key is pressed, the status changes as shown to the left. The No. 2 display at this time shows the currently entered count value in hexadecimal. Set the STV to 20 mA.



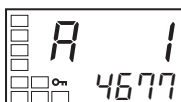

Allow the count value on the No. 2 display to fully stabilize, then press the  key to temporarily register the calibration settings. If this count value is outside of the specified range, the No. 2 display will flash and the count value will not be temporarily registered.



6. When the  key is pressed, the status changes as shown to the left. Set the STV to 1 mA.

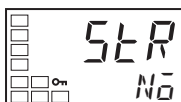

Allow the count value on the No. 2 display to fully stabilize, then press the  key to temporarily register the calibration settings. If this count value is outside of the specified range, the No. 2 display will flash and the count value will not be temporarily registered.

7. When the  key is pressed, the status changes as shown to the left. The data to be temporarily registered is not displayed if it is not complete. Press the  key. The No. 2 display changes to 5E5. Release the key and wait two seconds or press the  key. This stores the temporarily registered calibration data to EEPROM.



To cancel the saving of temporarily registered calibration data to EEPROM, press the  key (while No is displayed in the No. 2 display) without pressing the  key.

8. The calibration mode is ended by turning the power OFF.

6-6-2 Calibrating a Voltage Input

In this example, calibration is shown for a Controller with an Analog Input, with a voltage input set as the input type.

- 1,2,3... 1. Connect the power supply.
2. Connect an STV and DMM to the voltage input terminals, as shown in the following diagram.

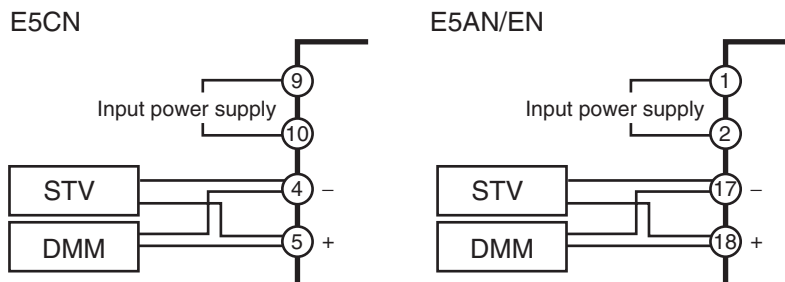

3. Turn the power ON.
4. Move to the calibration level.
This starts the 30-minute aging timer. This timer provides an approximate timer for aging. After 30 minutes have elapsed, the No. 2 display changes to 0. You can advance to the next step in this procedure even if 0 is not displayed.

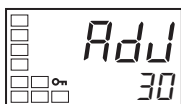

Input type 2 or 3:



Input type 4:

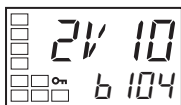

Input type 2 or 3:



Input type 4:

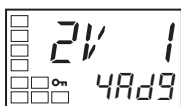

5. When the key is pressed, the status changes as shown to the left. The No. 2 display at this time shows the currently entered count value in hexadecimal. Set the STV as follows:
 - Input type 2 or 3: 5 V
 - Input type 4: 10 V
 Allow the count value on the No. 2 display to fully stabilize, then press the key to temporarily register the calibration settings. If this count value is outside of the specified range, the No. 2 display will flash and the count value will not be temporarily registered.
6. When the key is pressed, the status changes as shown to the left. Set the STV to 1 V.
Allow the count value on the No. 2 display to fully stabilize, then press the key to temporarily register the calibration settings. If this count value is outside of the specified range, the No. 2 display will flash and the count value will not be temporarily registered.

7. When the key is pressed, the status changes as shown to the left. The data to be temporarily registered is not displayed if it is not complete. Press the key. The No. 2 display changes to 4E5. Release the key and wait two seconds or press the key. This stores the temporarily registered calibration data to EEPROM.
To cancel the saving of temporarily registered calibration data to EEPROM, press the key (while N0 is displayed in the No. 2 display) without pressing the key.

8. The calibration mode is ended by turning the power OFF.

6-7 Checking Indication Accuracy

- After calibrating the input, be sure to check the indication accuracy to make sure that the calibration has been executed correctly.
- Operate the E5CN/CN-U/AN/EN in the process value/set point monitor mode.
- Check the indication accuracy at the following three values: upper limit, lower limit, and mid-point.

6-7-1 Thermocouple or Infrared Temperature Sensor

- Preparations

The diagram below shows the required device connections. Make sure that the E5CN/CN-U/AN/EN and cold junction compensator are connected by a compensating conductor for the thermocouple that is to be used during actual operation.

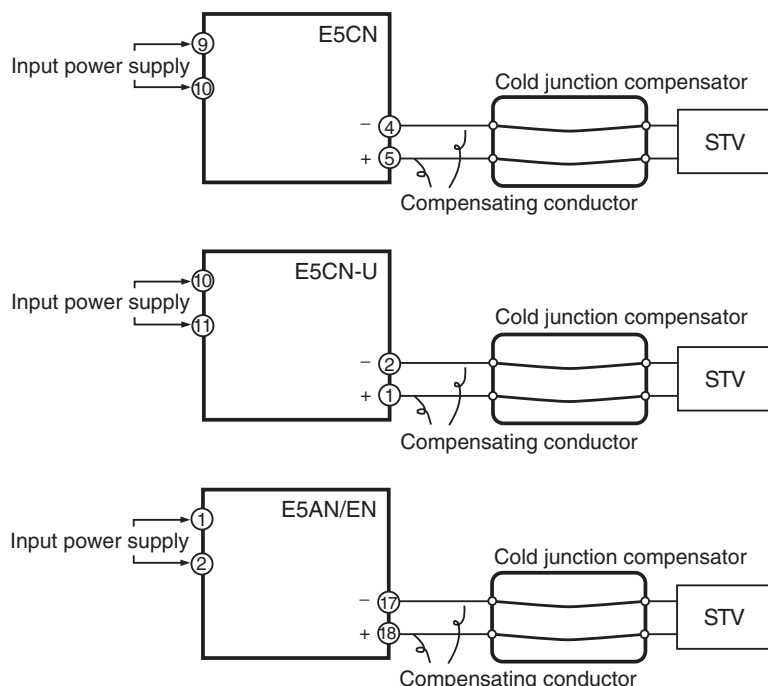

- Operation

Make sure that the cold junction compensator is at 0°C, and set the STV output to the voltage equivalent of the starting power of the check value. The cold junction compensator and compensation conductor are not required when an external cold junction compensation method is used.

6-7-2 Platinum Resistance Thermometer

- Preparations

The diagram below shows the required device connections.

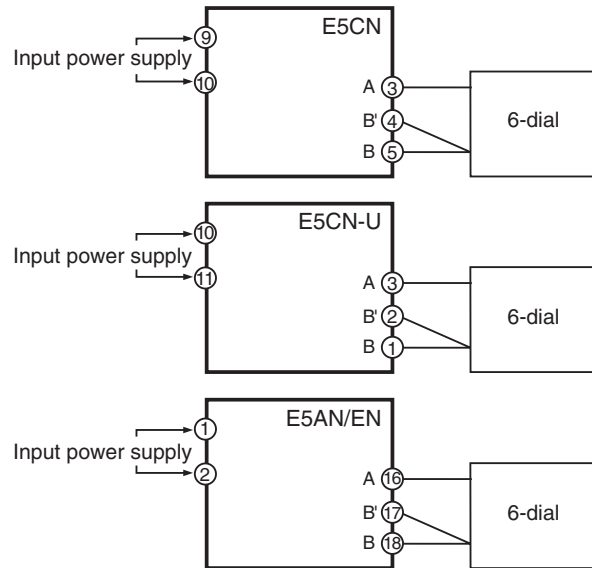

- Operation

Set the 6-dial to the resistance equivalent to the check value.

6-7-3 Analog Input

- Preparations

The diagram below shows the required device connections.

(The connection terminals depend on the model and input type.)

Controller with a Thermocouple/Resistance Thermometer Multi-input (Analog Input)

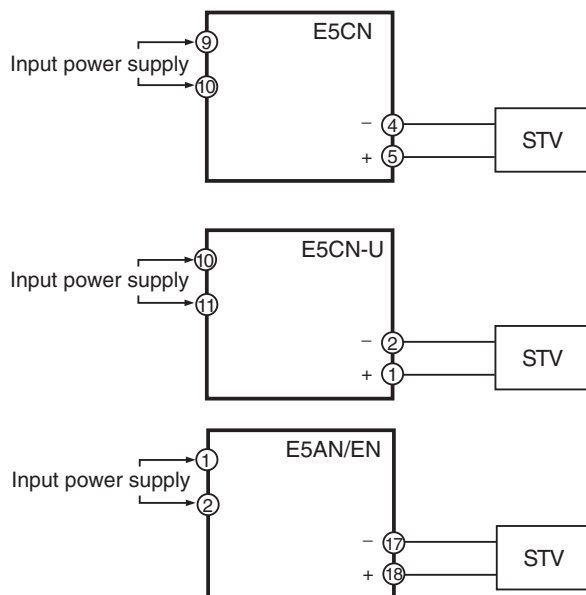

Current Input for a Controller with an Analog Input

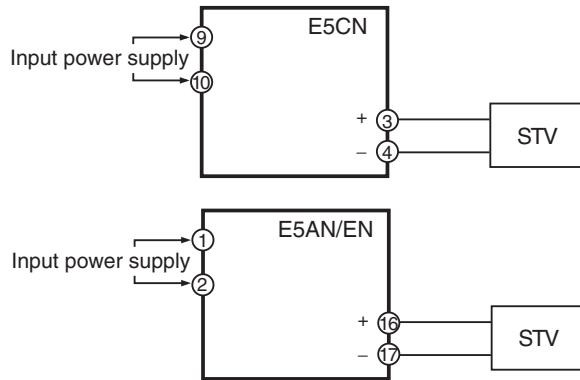

Voltage Input for a Controller with an Analog Input

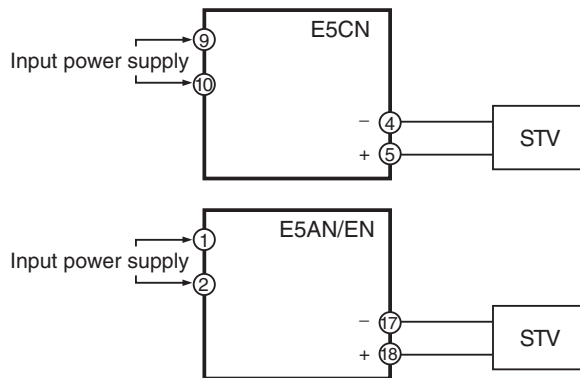

- Operation
Set the STV output to the voltage or current equivalent to the check value.

Appendix A

Specifications

Ratings

Supply voltage	100 to 240 VAC, 50/60 Hz	24 VAC, 50/60 Hz/24 VDC	
Operating voltage range	85 to 110% of rated supply voltage		
Power consumption	E5CN	7.5 VA	5 VA/3 W
	E5CN-U	6 VA	3 VA/2 W
	E5AN	11 VA	5.5 VA/4 W
	E5EN	10 VA	5.5 VA/4 W
Sensor input (See note 1.)	<p>Temperature input type Thermocouple: K, J, T, E, L, U, N, R, S, B Platinum resistance thermometer: Pt100, JPt100 Infrared temperature sensor: 10 to 70°C, 60 to 120°C, 115 to 165°C, 140 to 260°C Voltage input: 0 to 50 mV</p> <p>Controllers with Analog Inputs (See note 2.) Current input: 4 to 20 mA, 0 to 20 mA (Input impedance: 150 Ω max.) Voltage input: 1 to 5 V, 0 to 5 V, 0 to 10 V (Input impedance: 1 MΩ max.)</p>		
Control output	Relay output	E5CN	Relay output: SPST-NO, 250 VAC, 3 A (resistive load), electrical durability: 100,000 operations Min. applicable load: 5 V, 10 mA Long-life relay output: SPST-NO, 250 VAC, 3 A (resistive load), electrical durability: 1,000,000 operations Load power supply voltage: 75 to 250 VAC (See note 3.) Leakage current: 5 mA max. (250 VAC, 60 Hz)
		E5CN-U	SPDT, 250 VAC, 3A (resistive load), electrical durability: 100,000 operations Min. applicable load 5 V 10 mA
		E5AN E5EN	Relay output: SPST-NO, 250 VAC, 5 A (resistive load), electrical durability: 100,000 operations Min. applicable load: 5 V, 10 mA Long-life relay output: SPST-NO, 250 VAC, 3 A (resistive load), electrical durability: 1,000,000 operations Load power supply voltage: 75 to 250 VAC (See note 3.) Leakage current: 5 mA max. (250 VAC, 60 Hz)
	Voltage output	E5CN E5CN-U	Output voltage 12 VDC ±15% (PNP), max. load current 21 mA, with short-circuit protection circuit
		E5AN E5EN	Output voltage 12 VDC +15%/-20% (PNP), max. load current 40 mA, with short-circuit protection circuit Note Control output 2: 12 VDC +15%/-20% (PNP), max. load current 21 mA, with short-circuit protection circuit
	Current output	4 to 20 mA DC, 0 to 20 mA DC, Load: 600 Ω max., Resolution: approx. 2,700	
Alarm output	E5CN E5CN-U	SPST-NO, 250 VAC, 1 A (resistive load), electrical durability: 100,000 operations Min. applicable load: 1 V, 1 mA	
	E5AN E5EN	SPST-NO, 250 VAC, 3 A (resistive load), electrical durability: 100,000 operations Min. applicable load: 1 V, 1 mA	
Control method	2-PID or ON/OFF control		
Setting method	Digital setting using front panel keys		

Indication method	11-segment/7-segment digital display and single-lighting indicator
Other functions	Depend on the model
Ambient temperature	-10 to 55°C (with no condensation or icing); with 3-year guarantee: -10 to 50°C
Ambient humidity	25% to 85%
Storage temperature	-25 to 65°C (with no condensation or icing)
Altitude	2,000 m or less
Recommended fuse	T2A, 250 VAC, time lag, low shut-off capacity
Installation environment	Installation Category II, Pollution Class 2 (IEC 61010-1 compliant)

- Note**
- (1) For the setting ranges for each sensor input, see page 219.
 - (2) When connecting the ES2-THB, connect it 1:1.
 - (3) Always connect an AC load to a long-life relay output. The output will not turn OFF if a DC load is connected, because a triac is used for switching when closing and opening the circuit.

HBA and HS Alarm (for Controller with Heater Burnout and HS Alarm)

Max. heater current	50 A AC
Input current readout accuracy	±5% FS ±1 digit max.
Heater burnout alarm setting range	0.1 to 49.9 A (0.1 A units) 0.0 A: Heater burnout alarm output turns OFF. 50.0 A: Heater burnout alarm output turns ON. Min. detection ON time: 190 ms (See note 1.)
HS alarm setting range	0.1 to 49.9 A (0.1 A units) 0.0 A: HS alarm output turns ON. 50.0 A: HS alarm output turns OFF. Min. detection OFF time: 190 ms (See note 2.)

- Note**
- (1) When the control output 1 ON time is less than 190 ms, heater burnout detection and heater current measurement are not performed.
 - (2) When the control output 1 OFF time is less than 190 ms, HS alarm and leakage current measurement are not performed.

External Power Supply for ES1B

Output voltage	12 VDC ±10%
Output current	20 mA max.

Note Contact your OMRON representative for information on using the external power supply for ES1B for other applications.

Characteristics

Indication accuracy (ambient temperature of 23°C)	Thermocouple (See note 1.): E5CN/AN/EN: (±0.5% of indication value or ±1°C, whichever is greater) ±1 digit max. E5CN-U: (±1% of indication value or ±2°C, whichever is greater) ±1 digit max. Platinum resistance thermometer: (±0.5% of indication value or ±1°C, whichever is greater) ±1 digit max. Analog input: ±0.5% FS ±1 digit max. CT input: ±5% FS ±1 digit max.
Temperature variation influence (See note 2.)	Thermocouple (R, S, B) (±1% of PV or ±10°C, whichever is greater) ±1 digit max. (E5CN) (±2% of PV or ±10°C, whichever is greater) ±1 digit max. (E5CN-U) Other thermocouples: (±1% of PV or ±4°C, whichever is greater) ±1 digit max. (E5CN) (±2% of PV or ±4°C, whichever is greater) ±1 digit max. (E5CN-U)
Voltage variation influence (See note 2.)	*K thermocouple at -100°C max: ±10°C max. Platinum resistance thermometer: (±1% of PV or ±2°C, whichever is greater) ±1 digit max. Analog input: ±1% FS ±1 digit max. (See note 2.)

Hysteresis	Controllers with Thermocouple/Resistance Thermometer Multi-inputs	0.1 to 999.9°C or °F (in units of 0.1°C or °F) (See note 3.)		
	Controllers with Analog Inputs	0.01% to 99.99% FS (in units of 0.01% FS)		
Proportional band (P)	Controllers with Thermocouple/Resistance Thermometer Multi-inputs	0.1 to 999.9°C or °F (in units of 0.1 EU) (See note 3.)		
	Controllers with Analog Inputs	0.1% to 999.9% FS (in units of 0.1% FS)		
Integral time (I)	0 to 3,999 s (in units of 1 s)			
Derivative time (D)	0 to 3,999 s (in units of 1 s) When RT is ON: 0.0 to 999.9 (in units of 0.1 s)			
Control Period	0.5, 1 to 99 s (in units of 1 s)			
Manual reset value	0.0% to 100.0% (in units of 0.1%)			
Alarm setting range	-1,999 to 9,999 (decimal point position depends on input type)			
Sampling period	250 ms			
Insulation resistance	20 MΩ min. (at 500 VDC)			
Dielectric strength	2,000 VAC, 50/60 Hz for 1 min between terminals of different charge			
Malfunction vibration	10 to 55 Hz, 20 m/s ² for 10 min each in X, Y and Z directions			
Vibration resistance	10 to 55 Hz, peak height amplitude of 0.75 mm for 2 hr each in X, Y, and Z directions			
Malfunction shock	100 m/s ² , 3 times each in X, Y, and Z directions			
Shock resistance	300 m/s ² , 3 times each in X, Y, and Z directions			
Weight	E5CN	Approx. 150 g	Adapter: approx. 10 g	Terminal cover: approx. 10 g
	E5CN-U	Approx. 110 g		---
	E5AN	Approx. 310 g	Adapter: approx. 100 g	Terminal cover: approx. 20 g
	E5EN	Approx. 260 g		---
Degree of protection	E5CN E5AN E5EN	Front panel: NEMA4X for indoor use (equivalent to IP66), rear case: IP20, terminals: IP00		
	E5CN-U	Front panel: IP50, rear case: IP20, terminals: IP00		
Memory protection	EEPROM (non-volatile memory) (number of writes: 1,000,000)			

Note (1) The indication of K thermocouples in the -200 to 1,300°C range, T and N thermocouples at a temperature of -100°C or less, and U and L thermocouples at any temperature is ±2°C ±1 digit maximum. The indication of B thermocouples at a temperature of 400°C or less is not specified. The indication of R and S thermocouples at a temperature of 200°C or less is ±3°C ±1 digit maximum.

(2) Ambient temperature: -10°C to 23°C to 55°C
Voltage range: -15 to +10% of rated voltage

(3) Set "none" as the unit for Controllers with Analog Inputs.

Current Transformer (CT)

Specifications

Item	Specifications	
Model number	E54-CT1	E54-CT3
Max. continuous current	50 A	120 A (See note.)
Dielectric strength	1,000 VAC (for 1 min)	
Vibration resistance	50 Hz, 98 m/s ²	
Weight	Approx. 11.5 g	Approx. 50 g
Accessories	None	Armature (2) Plug (2)

Note The maximum continuous current of the E5□N is 50 A.

External Dimensions

E54-CT1

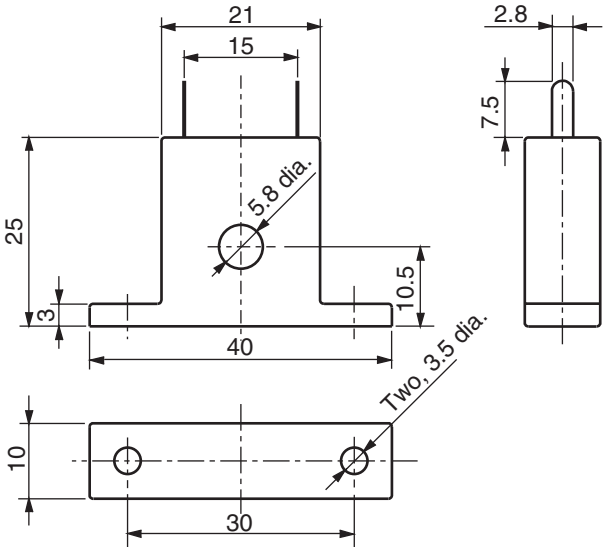

E54-CT3

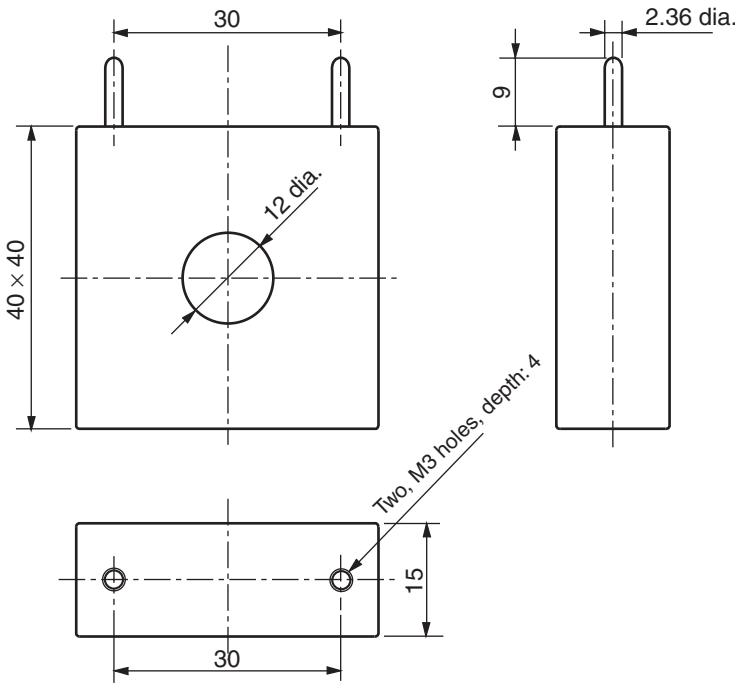

E58-CIFQ1 USB-Serial Conversion Cable

Specifications

Item	Specifications
Applicable OS	Windows 2000/XP
Applicable software	Thermo Mini, CX-Thermo
Applicable models	OMRON E5CN/CN-U Digital Temperature Controllers
USB interface rating	Conforms to USB Specification 1.1
DTE speed	38,400 bps
Connector specifications	Computer end: USB (type A plug) Temperature Controller end: Serial
Power supply	Bus power (5 VDC supplied from USB host controller)
Current consumption	70 mA
Ambient operating temperature	0 to 55°C (with no condensation or icing)
Ambient operating humidity	10% to 80%
Storage temperature	-20 to 60°C (with no condensation or icing)
Storage humidity	10% to 80%
Altitude	2,000 m max.
Weight	Approx. 100 g

Compatible Operating Environment

A personal computer that includes the following specifications is required.

- USB port
- CD-ROM drive
- Windows 2000/XP

Appearance and Nomenclature

Appearance

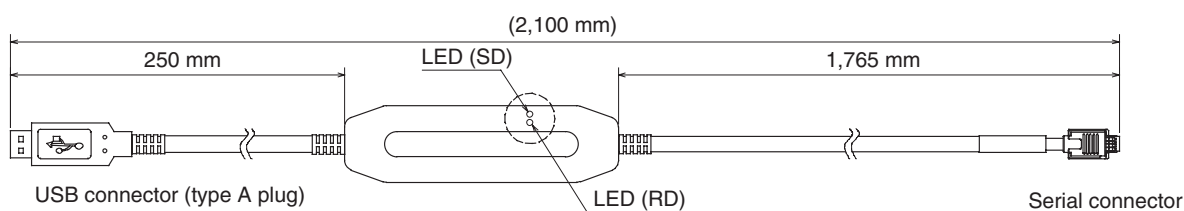

LED Indicator Display

Indicator	Color	Status	Meaning
SD	Yellow	Lit	Sending data from USB-Serial Conversion Cable
		Not lit	Not sending data from USB-Serial Conversion Cable
RD	Yellow	Lit	Sending data from USB-Serial Conversion Cable
		Not lit	Not sending data from USB-Serial Conversion Cable

Error Displays

When an error occurs, the error contents are shown on the No. 1 display.

This section describes how to check error codes on the display, and the actions to be taken to remedy the problems.

Input Error

Meaning

The input value has exceeded the control range. (See note.)

Note Control Range

Resistance thermometer, thermocouple input:	Temperature setting lower limit – 20°C to temperature setting upper limit + 20°C (Temperature setting lower limit – 40°F to temperature setting upper limit + 40°F)
ES1B input:	Same as input indication range
Analog input	–5% to +105% of scaling range

Action

Check the wiring of inputs for miswiring, disconnections, and short-circuits and check the input type.

If no abnormality is found in the wiring and input type, turn the power OFF then back ON again.

If the display remains the same, the Controller must be replaced. If the display is restored, then the probable cause is electrical noise affecting the control system. Check for electrical noise.

Operation at Error

After an error occurs, the error is displayed and the alarm outputs function as if the upper limit has been exceeded.

When the “input error output” parameter in the advanced function level is set to ON, the alarm 1 output turns ON whenever an input error occurs.

An error message is displayed when the PV, PV/SP, or PV/MV is displayed.

Note When the manual MV, MV at stop, or MV at PV error is set, the control output corresponds to the set value.

Display Range Exceeded

Meaning

Though this is not an error, it is displayed if the process value exceeds the display range when the control range is larger than the display range.

The display ranges are shown below (with decimal points omitted).

- When less than –1,999 CCCC
- When more than 9,999 JJJJ

Action

Control continues, allowing normal operation. The message is displayed when the PV, PV/SP, or PV/MV is displayed.

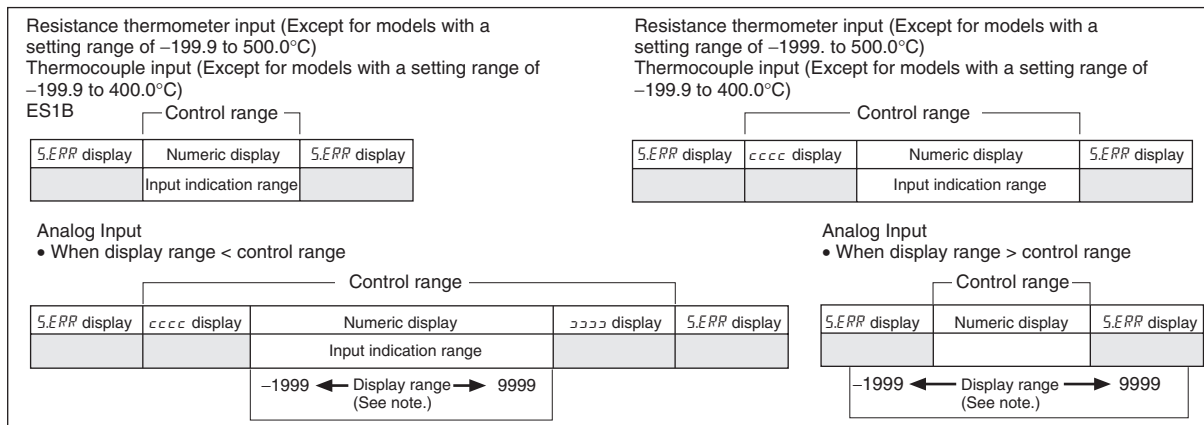

Note: The display range is shown in numbers with decimal points omitted.

H.ERR

HB Error (See note.)

Meaning

There is an error in internal circuits.

Action

First, turn the power OFF then back ON again. If the display remains the same, the Controller must be repaired. If the display is restored, then the probable cause is electrical noise affecting the control system. Check for electrical noise.

Action

The control outputs and alarm outputs turn OFF. An error message is displayed when the PV, PV/SP, or PV/MV is displayed.

When the manual MV, MV at stop, or MV at PV error is set, the control output corresponds to the set value.

For alarm outputs, the operation indicators and status normally turn OFF, but they will turn ON if the “close in alarm” parameter for alarms 1, 2, or 3 in the advanced function setting level is set to $\overline{M-L}$ (Close in alarm).

Note Applies to the E5□N-□□H□ and E5□N-□□HH□.

E111

Memory Error

Meaning

Internal memory operation is in error.

Action

First, turn the power OFF then back ON again. If the display remains the same, the Controller must be repaired. If the display is restored, then the probable cause is electrical noise affecting the control system. Check for electrical noise.

Operation at Error

Control output and alarm output turn OFF. (Current output is approx. 0 mA).

FFFF

Current Value Exceeds**Meaning**

This error is displayed when the heater current value exceeds 55.0 A.

Action

Control continues, allowing normal operation. An error message is displayed when the following items are displayed.

- Heater current 1 value monitor
- Heater current 2 value monitor
- Leakage current 1 monitor
- Leakage current 2 monitor

Et1

Et2

LCR1

LCR2

**Heater Burnout
HS Alarm****Meaning**

When heater burnout or an HS alarm occurs, the No. 1 display in the applicable setting level flashes.

Action

When either heater burnout or HS is detected, the HA indicator lights and the No. 1 display flashes for the applicable “heater current 1 value monitor,” “heater current 2 value monitor,” “leakage current 1 monitor,” or “leakage current 1 monitor” parameters in the operation level and adjustment level. Control continues, allowing normal operation.

Troubleshooting**Checking Problems**

If the Temperature Controller is not operating normally, check the following points before requesting repairs. If the problem persists, contact your OMRON representative for details on returning the product.

Timing	Status	Meaning	Countermeasures	Page
Turning ON the power for the first time	Temperature unit (°C/°F) is flashing.	ST (self-tuning) is in progress (default setting: ON).	This is not a product fault. The temperature unit (°C/°F) flashes while ST (self-tuning) is being performed	46
	Temperature error is large. Input error (S.Err display)	Input type mismatch	Check the sensor type and reset the input type correctly.	36
		Thermometer is not installed properly.	Check the thermometer installation location and polarity and install correctly.	21
	Communications are not possible.	Non-recommended adapter is being used.	Make sure that the connected device is not faulty.	Section 1 of <i>Communications User's Manual</i>

Timing	Status	Meaning	Countermeasures	Page
During operation	Overshooting Undershooting Hunting	ON/OFF control is enabled (default: ON/OFF control selected).	Select PID control and execute either ST (self-tuning) or AT (auto-tuning). When using self-tuning, turn ON the power supply to the Temperature Controller and load (heater, etc.) at the same time, or turn ON the load power supply first. Accurate self-tuning and optimum control will not be possible if the power supply to the load is turned ON after turning ON the power supply to the Temperature Controller.	45
		Control cycle is longer compared with the speed of rise and fall in temperature	Shorten the control cycle. A shorter control cycle improves control performance, but a cycle of 20 ms minimum is recommended in consideration of the service life of the relays.	38
		Unsuitable PID constant	Set appropriate PID constants using either of the following methods. <ul style="list-style-type: none"> Execute AT (autotuning). Set PID constants individually using manual settings. 	45
		HS alarm operation fault	Use breeder resistance if the problem is due to leakage current. Also investigate the errors detected by the HS alarm function.	54
Temperature is not rising	Temperature is not rising	Specified operation is unsuitable for required control (default: Reverse operation)	Select either forward or reverse operation depending on the required control. Reverse operation is used for heating operations.	38
		Heater is burnt out or deteriorated.	Check whether heater burnout or deterioration have occurred. Also investigate the errors detected by the heater burnout alarm.	54
		Insufficient heater capacity	Check whether the heater's heating capacity is sufficient.	---
		Cooling system in operation.	Check whether a cooling system is operating.	---
		Peripheral devices have heat prevention device operating.	Set the heating prevention temperature setting to a value higher than the set temperature of the Temperature Controller.	---
Output will not turn ON	Output will not turn ON	Set to STOP (default: RUN)	Set the RUN/STOP mode to RUN. If STOP is lit on the display, control is stopped.	124
		Specified operation is unsuitable for required control (default: Reverse operation)	Select either forward or reverse operation depending on the required control. Reverse operation is used for heating operations.	38
		A high hysteresis is set for ON/OFF operation (default: 1.0°C)	Set a suitable value for the hysteresis.	43
Temperature Controller will not operate	Temperature Controller will not operate	Set to STOP (default: RUN)	Set the RUN/STOP mode to RUN. If STOP is lit on the display, control is stopped.	124

Timing	Status	Meaning	Countermeasures	Page
During operation (continued)	Temperature error is large Input error (S.err display)	Thermometer has burnt out or short-circuited.	Check whether the thermometer has burnt out or short-circuited	---
		Thermometer lead wires and power lines are in the same conduit, causing noise from the power lines (generally, display values will be unstable).	Wire the lead wires and power lines in separate conduits, or wiring using a more direct path.	---
		Connection between the Temperature Controller and thermocouple is using copper wires.	Connect the thermocouple's lead wires directly, or connect a compensating conductor suitable for the thermocouple.	---
		Installation location of thermometer is unsuitable.	Check whether the location of the thermometer is suitable.	---
		Input shift is not set correctly (default: 0°C)	Set a suitable input shift. If input shift is not required, set the input shift value to 3.	67
	Keys will not operate	Setting change protect is ON.	Turn OFF setting change protect.	85
	Cannot shift levels	Operations limited due to protection.	Set the operation/adjustment protect, initial setting/communications protect, and setting change protect values as required.	85
After long service life	Control is unstable	Terminal screws may be loose.	Retighten terminal screws to a torque of 1.13 to 1.36 N·m (see note).	22
		The internal components have reached the end of their service life.	The Temperature Controller's internal electrolytic capacitor depends on the ambient temperature, and load rate. The structural life depends on the ambient environment (shock, vibration). The life expectancy of the output relays varies greatly with the switching capacity and other switching conditions. Always use the output relays within their rated load and electrical life expectancy. If an output relay is used beyond its life expectancy, its contacts may become welded or burned. Replace the Temperature Controller and all other Temperature Controllers purchased in the same time period.	---

Note The tightening torque for E5CN-U is 0.5 N·m.

Parameter Operation Lists

Multi-input: Controllers with Thermocouple/Resistance Thermometer Multi-inputs

Analog input: Controllers with Analog Inputs

Operation Level

Parameters	Characters	Setting (monitor) value	Display	Default	Unit	Set value
Process value		Sensor input indication range			EU	
Set point		SP lower limit to SP upper limit		0	EU	
Auto/manual switch	<i>R-M</i>					
Multi-SP set point setting	<i>M-SP</i>	0 to 3		0	None	
Set point during SP ramp	<i>SP-M</i>	SP lower limit to SP upper limit			EU	
Heater current 1 value monitor	<i>EE1</i>	0.0 to 55.0			A	
Heater current 2 value monitor	<i>EE2</i>	0.0 to 55.0			A	
Leakage current 1 monitor	<i>LEP1</i>	0.0 to 55.0			A	
Leakage current 2 monitor	<i>LEP2</i>	0.0 to 55.0			A	
Program start	<i>RSET</i>	RSET, STRT	<i>RSET, SETRT</i>	RSET	None	
Soak time remain	<i>SKTR</i>	0 to 9999			min or h	
RUN/STOP	<i>R-S</i>	RUN/STOP	<i>RUN, StOP</i>	Run	None	
Alarm value 1	<i>AL-1</i>	-1999 to 9999		0	EU	
Alarm value upper-limit 1	<i>AL1H</i>	-1999 to 9999		0	EU	
Alarm value lower-limit 1	<i>AL1L</i>	-1999 to 9999		0	EU	
Alarm value 2	<i>AL-2</i>	-1999 to 9999		0	EU	
Alarm value upper-limit 2	<i>AL2H</i>	-1999 to 9999		0	EU	
Alarm value lower-limit 2	<i>AL2L</i>	-1999 to 9999		0	EU	
Alarm value 3	<i>AL-3</i>	-1999 to 9999		0	EU	
Alarm value upper-limit 3	<i>AL3H</i>	-1999 to 9999		0	EU	
Alarm value lower-limit 3	<i>AL3L</i>	-1999 to 9999		0	EU	
MV monitor (heating)	<i>α</i>	-5.0 to 105.5 (standard) 0.0 to 105.0 (heating/cooling)			%	
MV monitor (cooling)	<i>ε-α</i>	0.0 to 105.0			%	

Adjustment Level

Parameters	Characters	Setting (monitor) value	Display	Default	Unit	Set value
Adjustment level display	<i>LAdj</i>					
AT execute/cancel	<i>At</i>	OFF, ON	<i>OFF, ON</i>	OFF	None	
Communications writing	<i>CMWt</i>	OFF, ON	<i>OFF, ON</i>	OFF	None	
Heater current 1 value monitor	<i>Et1</i>	0.0 to 55.0			A	
Heater current 2 value monitor	<i>Et2</i>	0.0 to 55.0			A	
Leakage current 1 monitor	<i>LEP1</i>	0.0 to 55.0			A	
Leakage current 2 monitor	<i>LEP2</i>	0.0 to 55.0			A	
Heater burnout detection 1	<i>Hb1</i>	0.0 to 50.0		0.0	A	
Heater burnout detection 2	<i>Hb2</i>	0.0 to 50.0		0.0	A	
HS alarm 1	<i>HS1</i>	0.0 to 50.0		50.0	A	
HS alarm 2	<i>HS2</i>	0.0 to 50.0		50.0	A	
SP 0	<i>SP-0</i>	SP lower limit to SP upper limit		0	EU	
SP 1	<i>SP-1</i>	SP lower limit to SP upper limit		0	EU	
SP 2	<i>SP-2</i>	SP lower limit to SP upper limit		0	EU	
SP 3	<i>SP-3</i>	SP lower limit to SP upper limit		0	EU	
Temperature input shift	<i>TNS</i>	-199.9 to 999.9		0.0	°C or °F	
Upper-limit temperature input shift value	<i>TNSH</i>	-199.9 to 999.9		0.0	°C or °F	
Lower-limit temperature input shift value	<i>TNSL</i>	-199.9 to 999.9		0.0	°C or °F	
Proportional band	<i>P</i>	Multi-input: 0.1 to 999.9		8.0	°C or °F (See note 6.)	
		Analog input: 0.1 to 999.9		10.0	%FS	
Integral time	<i>I</i>	0 to 3,999		233	Second	
Derivative time	<i>d</i>	RT OFF: 0 to 3,999		40	Second	
		RT ON: 0.0 to 999.9		40.0	Second	
Cooling coefficient	<i>E-Sc</i>	0.01 to 99.99		1.00	None	
Dead band	<i>E-db</i>	Multi-input: -199.9 to 999.9		0.0	°C or °F (See note 6.)	
		Analog input: -19.99 to 99.99		0.00	%FS	
Manual reset value	<i>OF-R</i>	0.0 to 100.0		50.0	%	
Hysteresis (heating)	<i>HYS</i>	Multi-input: 0.1 to 999.9		1.0	°C or °F (See note 6.)	
		Analog input: 0.01 to 99.99		0.10	%FS	

Parameters	Characters	Setting (monitor) value	Display	Default	Unit	Set value
Hysteresis (cooling)	EHYS	Multi-input: 0.1 to 999.9		1.0	°C or °F (See note 6.)	
		Analog input: 0.01 to 99.99		0.10	%FS	
Soak time	SOAK	1 to 9,999		1	min or h	
Wait band	WT-b	Multi-input: OFF, 0.1 to 999.9	OFF, 0.1 to 999.9	OFF	°C or °F (See note 6.)	
		Analog input: OFF, 0.01 to 99.99	OFF, 0.01 to 99.99	OFF	%FS	
MV at stop	MV-S	-5.0 to 105.0 (standard) -105.0 to 105.0 (heating/cooling)		0.0	%	
MV at PV error	MV-E	-5.0 to 105.0 (standard) -105.0 to 105.0 (heating/cooling)		0.0	%	
SP ramp set value	SPRL	OFF or 1 to 9,999	OFF, 1 to 9999	OFF	EU/s, EU/min	
MV upper limit	UL-H	MV lower limit +0.1 /105.0 (standard) 0.0 to 105.0 (heating/cooling)		105.0	%	
MV lower limit	UL-L	-5.0 to MV upper limit -0.1 (standard) -105.0 to 0.0 (heating/cooling)		-5.0 (standard) -105.0 (heating/cooling)	%	

Initial Setting Level

Parameters	Characters	Setting (monitor) value	Display	Default	Unit	Set value
Input type	IN-L	Multi-input	0: Pt100 1: Pt100 2: Pt100 3: JPt100 4: JPt100 5: K 6: K 7: J 8: J 9: T 10: T 11: E 12: L 13: U 14: U 15: N 16: R 17: S 18: B 19: 10 to 70°C 20: 60 to 120°C 21: 115 to 165°C 22: 160 to 260°C 23: 0 to 50 mV		5	None
		Analog input	0: 4 to 20 mA 1: 0 to 20 mA 2: 1 to 5 V 3: 0 to 5 V 4: 0 to 10 V		0	None
Scaling upper limit	IN-H	Scaling lower limit + 1 to 9,999		100	None	

Parameters	Characters	Setting (monitor) value	Display	Default	Unit	Set value
Scaling lower limit	$\bar{L}N-L$	-1,999 to scaling upper limit -1		0	None	
Decimal point	dP	Multi-input: 0 to 1		0	None	
		Analog input: 0 to 3		0	None	
Temperature unit	$d-U$	°C, °F	\bar{C}, F	°C	None	
SP upper limit	$SL-H$	SP lower limit + 1 / input range lower limit (tempera- ture)		1300	EU	
		SP lower limit + 1 / scaling upper limit (analog)		100		
SP lower limit	$SL-L$	Input range lower limit to SP upper limit - 1 (temperature)		-200	EU	
		Scaling lower limit to SP upper limit - 1 (analog)		0		
PID ON/OFF	$\bar{L}N\bar{E}L$	ON/OFF 2-PID	$\bar{a}N\bar{a}F, P\bar{L}d$	ON/OFF	None	
Standard or heating/ cooling	$S-H\bar{C}$	Standard or heating/cooling	$SENd, H-\bar{C}$	Standard	None	
ST	$S\bar{L}$	OFF, ON	$\bar{a}FF, \bar{a}N$	ON	None	
Program pattern	$P\bar{E}RN$	OFF, STOP, CONT	$\bar{a}FF, S\bar{L}\bar{a}P, \bar{C}\bar{a}N\bar{L}$	OFF	None	
Control period (heat)	$\bar{C}P$	0.5 or 1 to 99	$\bar{0}.5, 1\text{ to }99$	20	Second	
Control period (cool)	$\bar{C}-\bar{C}P$	0.5 or 1 to 99	$\bar{0}.5, 1\text{ to }99$	20	Second	
Direct/reverse opera- tion	$\bar{a}REV$	Reverse operation, direct operation	$\bar{a}R-R, \bar{a}R-d$	Reverse operation	None	
Alarm 1 type	$R\bar{L}\bar{L}1$	0: Alarm function OFF 1: Upper and lower-limit alarm 2: Upper-limit alarm 3: Lower-limit alarm 4: Upper and lower-limit range alarm 5: Upper and lower-limit alarm with standby sequence 6: Upper-limit alarm with standby sequence 7: Lower-limit alarm with standby sequence 8: Absolute-value upper-limit alarm 9: Absolute-value lower-limit alarm 10: Absolute-value upper-limit alarm with standby sequence 11: Absolute-value lower-limit alarm with standby sequence 12: LBA (Loop Break Alarm)		2	None	

Parameters	Characters	Setting (monitor) value	Display	Default	Unit	Set value
Alarm 2 type	<i>RLLE2</i>	0: Alarm function OFF 1: Upper and lower-limit alarm 2: Upper-limit alarm 3: Lower-limit alarm 4: Upper and lower-limit range alarm 5: Upper and lower-limit alarm with standby sequence 6: Upper-limit alarm with standby sequence 7: Lower-limit alarm with standby sequence 8: Absolute-value upper-limit alarm 9: Absolute-value lower-limit alarm 10: Absolute-value upper-limit alarm with standby sequence 11: Absolute-value lower-limit alarm with standby sequence		2	None	
Alarm 3 type	<i>RLLE3</i>	Same settings as the alarm 2 type		2	None	
Transfer output type	<i>ER-E</i>	OFF: OFF SP: Set point SP-M: Ramp set point PV: Process value MV: Manipulated variable (heating) C-MV: Manipulated variable (cooling)	<i>OFF</i> <i>SP</i> <i>SP-M</i> <i>PV</i> <i>MV</i> <i>C-MV</i>	OFF	None	
Transfer output upper limit	<i>ER-H</i>	See note 1.		See note 1.	See note 1.	
Transfer output lower limit	<i>ER-L</i>	See note 1.		See note 1.	See note 1.	
Linear current output	<i>AI-E</i>	4-20: 4 to 20 mA 0-20: 0 to 20 mA	<i>4-20, 0-20</i>	4-20	None	
Move to advanced function setting level	<i>RM0V</i>	-1999 to 9,999		0	None	

Manual Control Level

Parameters	Characters	Setting (monitor) value	Display	Default	Unit	Set value
Manual MV		-5.0 to 105.0 (standard) -105.0 to 105.0 (heating/cooling)		0.0	%	

Advanced Function Setting Level

Parameters	Characters	Setting (monitor) value	Display	Default	Unit	Set value
Parameter initialization	<i>INLE</i>	OFF, FACT	<i>OFF, FACT</i>	OFF	None	
Number of multi-SP uses	<i>EV-M</i>	0 to 2		1	None	
Event input assignment 1	<i>EV-I</i>	NONE: None STOP: RUN/STOP MANU: Auto/manual switch PRST: Program start (See note 5.)	<i>NONE,</i> <i>STOP,</i> <i>MANU, PRST</i>	NONE	None	

Parameters	Characters	Setting (monitor) value	Display	Default	Unit	Set value
Event input assignment 2	<i>EV-2</i>	NONE: None STOP: RUN/STOP MANU: Auto/manual switch PRST: Program start (See note 5.)	<i>NONE, SEOP, MANU, PRST</i>	STOP	None	
Multi-SP uses	<i>MSPU</i>	OFF, ON	<i>OFF, ON</i>	OFF	None	
SP ramp time unit	<i>SPRU</i>	S: EU/second M: EU/minute	<i>S, M</i>	M	None	
Standby sequence reset	<i>RESET</i>	Condition A, condition B	<i>R, b</i>	Condition A	None	
Alarm 1 close in alarm	<i>AL1N</i>	N-O: Open in alarm N-C: Close in alarm	<i>N-O, N-C</i>	N-O	None	
Alarm 1 hysteresis	<i>ALH1</i>	Multi-input: 0.1 to 999.9		0.2	°C or °F (See note 6.)	
		Analog input: 0.01 to 99.99		0.02	%FS	
Alarm 2 close in alarm	<i>AL2N</i>	N-O: Open in alarm N-C: Close in alarm	<i>N-O, N-C</i>	N-O	None	
Alarm 2 hysteresis	<i>ALH2</i>	Multi-input: 0.1 to 999.9		0.2	°C or °F (See note 6.)	
		Analog input: 0.01 to 99.99		0.02	%FS	
Alarm 3 close in alarm	<i>AL3N</i>	N-O: Open in alarm N-C: Close in alarm	<i>N-O, N-C</i>	N-O	None	
Alarm 3 hysteresis	<i>ALH3</i>	Multi-input: 0.1 to 999.9		0.2	°C or °F (See note 6.)	
		Analog input: 0.01 to 99.99		0.02	%FS	
HB ON/OFF	<i>HbU</i>	OFF, ON	<i>OFF, ON</i>	ON	None	
Heater burnout latch	<i>HbL</i>	OFF, ON	<i>OFF, ON</i>	OFF	None	
Heater burnout hysteresis	<i>HbH</i>	0.1 to 50.0		0.1	A	
ST stable range	<i>St-b</i>	0.1 to 999.9		15.0	°C or °F	
α	<i>ALFA</i>	0.00 to 1.00		0.65	None	
Input digital filter	<i>INF</i>	0.0 to 999.9		0.0	Second	
Additional PV display	<i>PVAd</i>	OFF, ON	<i>OFF, ON</i>	OFF	None	
MV display	<i>OP</i>	OFF, ON	<i>OFF, ON</i>	OFF	None	
Automatic display return time	<i>RET</i>	OFF or 1 to 99	<i>OFF, 1 to 99</i>	OFF	Second	
Alarm 1 latch	<i>AL1L</i>	OFF, ON	<i>OFF, ON</i>	OFF	None	
Alarm 2 latch	<i>AL2L</i>	OFF, ON	<i>OFF, ON</i>	OFF	None	
Alarm 3 latch	<i>AL3L</i>	OFF, ON	<i>OFF, ON</i>	OFF	None	
Move to protect level time	<i>PRLT</i>	1 to 30		3	Second	
Input error output	<i>SERO</i>	OFF, ON	<i>OFF, ON</i>	OFF	None	
Cold junction compensation method	<i>CJC</i>	OFF, ON	<i>OFF, ON</i>	ON	None	
MB command logic switching	<i>RLRV</i>	OFF, ON	<i>OFF, ON</i>	OFF	None	

Parameters	Characters	Setting (monitor) value	Display	Default	Unit	Set value
PV change color	$\overline{C} \overline{a} L R$	Orange, Red, Green Red to Green: When ALM1 is lit, Green to Red: When ALM1 is lit Red to Green to Red Within PV stable band: Green Outside stable band: Red Green to Orange to Red Within PV stable band: Green Outside stable band: Green, Red Orange to Green to Red Within PV stable band: Green Outside stable band: Green, Red	$\overline{o} R \overline{O}, R E d,$ $\overline{G} R N$ $R - \overline{G}$ $\overline{G} - R$ $R - \overline{G}, R$ $\overline{G} - \overline{o}, R$ $\overline{o} - \overline{G}, R$	RED	None	
PV stable band	$PV - b$	Multi-input: 0.1 to 999.9		5.0	°C or °F (See note 6.)	
		Analog input: 0.01 to 99.99		5.00	%FS	
Alarm 1 ON delay	$R 1 \overline{o} N$	0 to 999 (0: ON delay disabled)		0	Second	
Alarm 2 ON delay	$R 2 \overline{o} N$	0 to 999 (0: ON delay disabled)		0	Second	
Alarm 3 ON delay	$R 3 \overline{o} N$	0 to 999 (0: ON delay disabled)		0	Second	
Alarm 1 OFF delay	$R 1 \overline{o} F$	0 to 999 (0: OFF delay disabled)		0	Second	
Alarm 2 OFF delay	$R 2 \overline{o} F$	0 to 999 (0: OFF delay disabled)		0	Second	
Alarm 3 OFF delay	$R 3 \overline{o} F$	0 to 999 (0: OFF delay disabled)		0	Second	
Input shift type	$\overline{C} S \overline{t} P$	INS1: Temperature input 1-point shift INS2: Temperature input 2-point shift	$\overline{C} N S 1, \overline{C} N S 2$	INS1	None	
MV at stop and error addition	$MV S \overline{t}$	OFF, ON	$\overline{o} F F, \overline{o} N$	OFF	None	
Auto/manual select addition	$R M A \overline{d}$	OFF, ON	$\overline{o} F F, \overline{o} N$	OFF	None	
RT	$R \overline{t}$	OFF, ON	$\overline{o} F F, \overline{o} N$	OFF	None	
HS alarm use	$H S U$	OFF, ON	$\overline{o} F F, \overline{o} N$	ON	None	
HS alarm latch	$H S L$	OFF, ON	$\overline{o} F F, \overline{o} N$	OFF	None	
HS alarm hysteresis	$H S H$	0.1 to 50.0		0.1	A	
LBA detection time	$L b A$	0 to 9999 (0: LBA function disabled)		0	Second	
LBA level	$L b A L$	Multi-input: 0.1 to 999.9		8.0	°C or °F (See note 6.)	
		Analog input: 0.01 to 99.99		10.00	%FS	
LBA band	$L b A b$	Multi-input: 0.0 to 999.9		3.0	°C or °F (See note 6.)	
		Analog input: 0.00 to 99.99		0.20	%FS	

Parameters	Characters	Setting (monitor) value	Display	Default	Unit	Set value
Control output 1 assignment	$\bar{a}Ut 1$	When control output 1 is a pulse output (See note 2.): NONE: No assignment O: Control output (heating) C-O: Control output (cooling) ALM1: Alarm 1 ALM2: Alarm 2 ALM3: Alarm 3 P.END: Program end output (See note 4.)	$N\bar{a}NE$ \bar{a} $\bar{C}-\bar{a}$ $ALM 1$ $ALM 2$ $ALM 3$ $P.END$	O	None	
		When control output 1 is a linear output (See note 2.): NONE: No assignment O: Control output (heating) C-O: Control output (cooling)	$N\bar{a}NE$ \bar{a} $\bar{C}-\bar{a}$			
Control output 2 assignment	$\bar{a}Ut 2$	NONE: No assignment O: Control output (heating) C-O: Control output (cooling) ALM1: Alarm 1 ALM2: Alarm 2 ALM3: Alarm 3 P.END: Program end output (See note 4.)	$N\bar{a}NE$ \bar{a} $\bar{C}-\bar{a}$ $ALM 1$ $ALM 2$ $ALM 3$ $P.END$	NONE	None	
Alarm 1 assignment	$ALM 1$	NONE: No assignment O: Control output (heating) C-O: Control output (cooling) ALM1: Alarm 1 ALM2: Alarm 2 ALM3: Alarm 3 P.END: Program end output (See note 4.)	$N\bar{a}NE$ \bar{a} $\bar{C}-\bar{a}$ $ALM 1$ $ALM 2$ $ALM 3$ $P.END$	ALM1	None	
Alarm 2 assignment	$ALM 2$	NONE: No assignment O: Control output (heating) C-O: Control output (cooling) ALM1: Alarm 1 ALM2: Alarm 2 ALM3: Alarm 3 P.END: Program end output (See note 4.)	$N\bar{a}NE$ \bar{a} $\bar{C}-\bar{a}$ $ALM 1$ $ALM 2$ $ALM 3$ $P.END$	ALM2	None	
Alarm 3 assignment (E5AN/E5EN only)	$ALM 3$	NONE: No assignment O: Control output (heating) C-O: Control output (cooling) ALM1: Alarm 1 ALM2: Alarm 2 ALM3: Alarm 3 P.END: Program end output (See note 4.)	$N\bar{a}NE$ \bar{a} $\bar{C}-\bar{a}$ $ALM 1$ $ALM 2$ $ALM 3$ $P.END$	ALM3	None	
Character select	$\bar{C}SEL$	OFF, ON	$\bar{a}FF, \bar{a}N$	ON	None	
Soak time unit	$\bar{t}-U$	M: Minutes; H: Hours	M, H	M	None	

Parameters	Characters	Setting (monitor) value	Display	Default	Unit	Set value
Alarm SP selection	<i>RLSP</i>	SP-M: Ramp set point SP: Set point	<i>SP-M, SP</i>	SP-M	None	
Move to calibration level	<i>LMOV</i>	-1999 to 9,999		0	None	

Protect Level

Parameters	Characters	Setting (monitor) value	Display	Default	Unit	Set value
Move to protect level	<i>PMOV</i>	-1999 to 9,999		0	None	
Operation/adjustment protect	<i>OPPE</i>	0 to 3		0	None	
Initial setting/communications protect	<i>ICPE</i>	0 to 2		1	None	
Setting change protect	<i>WPEE</i>	OFF, ON	<i>OFF, ON</i>	OFF	None	
Parameter mask enable	<i>PMSK</i>	OFF, ON	<i>OFF, ON</i>	ON	None	
Password to move to protect level	<i>PRLP</i>	-1999 to 9,999		0	None	

Communications Setting Level

Parameters	Characters	Setting (monitor) value	Display	Default	Unit	Set value
Protocol setting	<i>PSEL</i>	CompoWay/F (SYSWAY), Modbus (See note 3.)	<i>WF, Mod</i>	Compo- Way/F (SYSWAY)	None	
Communications Unit No.	<i>U-NO</i>	0 to 99		1	None	
Communications baud rate	<i>bPS</i>	1.2, 2.4, 4.8, 9.6, 19.2, or 38.4	<i>1.2, 2.4, 4.8, 9.6, 19.2, 38.4</i>	9.6	kbps	
Communications data length	<i>LEN</i>	7, 8		7	Bit	
Communications stop bits	<i>SBCE</i>	1, 2		2	Bit	
Communications parity	<i>PPEY</i>	None, Even, Odd	<i>NONE, EVEN, odd</i>	Even	None	
Send data wait time	<i>SDWT</i>	0 to 99		20	ms	

Note (1)

Transfer output type	Setting (monitor) range	Default (transfer output upper/lower limits) (See note 1.1.)	Unit
Set point	SP lower limit to SP upper limit	SP upper limit/lower limit	EU
Set point during SP ramp	SP lower limit to SP upper limit	SP upper limit/lower limit	EU
PV	Temperature: Sensor setting range lower limit to sensor setting range upper limit	Sensor setting range upper/lower limit	EU
	Analog: Scaling lower limit to scaling upper limit	Scaling upper/lower limit	EU
MV monitor (heating)	Standard: -5.0 to 105.0 Heating/cooling: 0.0 to 105.0	100.0/0.0	%
MV monitor (cooling)	0.0 to 105.0	100.0/0.0	%

(1.1) Initialized when the transfer output type is changed.

Initialized if the input type, temperature unit, scaling upper/lower limit, or SP upper/lower limit is changed when the transfer output type is SP, ramp SP, or PV.

(When initialized by the initializing settings, it is initialized to 100.0/0.0.)

- (2) The setting range depends on whether control output 1 is a linear output or pulse output.
- (3) When setting CWF, either CompoWay/F or SYSWAY can be used as the communications protocol. (CompoWay/F and SYSWAY are automatically identified by the command frames.)
- (4) P.END (program end output) can be set when the program pattern is not set to 0 (OFF).
- (5) PRST (program start) can be set when the program pattern is not set to 0 (OFF).
- (6) Set "none" as the unit for Controllers with Analog Inputs.

Sensor Input Setting Range, Indication Range, Control Range

	Input type	Specifications	Set value	Input temperature range	Input indication range
Controllers with Thermocouple/Resistance Thermometer Multi-inputs	Resistance thermometer	Pt100	0	-200 to 850 (°C)/-300 to 1,500 (°F)	-220 to 870 (°C)/-340 to 1,540 (°F)
			1	-199.9 to 500.0 (°C)/-199.9 to 900.0 (°F)	-199.9 to 520.0 (°C)/-199.9 to 940.0 (°F)
			2	0.0 to 100.0 (°C)/0.0 to 210.0 (°F)	-20.0 to 120.0 (°C)/-40.0 to 250.0 (°F)
		JPt100	3	-199.9 to 500.0 (°C)/-199.9 to 900.0 (°F)	-199.9 to 520.0 (°C)/-199.9 to 940.0 (°F)
			4	0.0 to 100.0 (°C)/0.0 to 210.0 (°F)	-20.0 to 120.0 (°C)/-40.0 to 250.0 (°F)
	Thermocouple	K	5	-200 to 1,300 (°C)/-300 to 2,300 (°F)	-220 to 1,320 (°C)/-340 to 2,340 (°F)
			6	-20.0 to 500.0 (°C)/0.0 to 900.0 (°F)	-40.0 to 520.0 (°C)/-40.0 to 940.0 (°F)
		J	7	-100 to 850 (°C)/-100 to 1,500 (°F)	-120 to 870 (°C)/-140 to 1,540 (°F)
			8	-20.0 to 400.0 (°C)/0.0 to 750.0 (°F)	-40.0 to 420.0 (°C)/-40.0 to 790.0 (°F)
		T	9	-200 to 400 (°C)/-300 to 700 (°F)	-220 to 420 (°C)/-340 to 740 (°F)
			10	-199.9 to 400.0 (°C)/-199.9 to 700.0 (°F)	-199.9 to 420.0 (°C)/-199.9 to 740.0 (°F)
		E	11	0 to 600 (°C)/0 to 1,100 (°F)	-20 to 620 (°C)/-40 to 1,140 (°F)
		L	12	-100 to 850 (°C)/-100 to 1,500 (°F)	-120 to 870 (°C)/-140 to 1,540 (°F)
		U	13	-200 to 400 (°C)/-300 to 700 (°F)	-220 to 420 (°C)/-340 to 740 (°F)
			14	-199.9 to 400.0 (°C)/-199.9 to 700.0 (°F)	-199.9 to 420.0 (°C)/-199.9 to 740.0 (°F)
		N	15	-200 to 1,300 (°C)/-300 to 2,300 (°F)	-220 to 1,320 (°C)/-340 to 2,340 (°F)
		R	16	0 to 1,700 (°C)/0 to 3,000 (°F)	-20 to 1,720 (°C)/-40 to 3,040 (°F)
		S	17	0 to 1,700 (°C)/0 to 3,000 (°F)	-20 to 1,720 (°C)/-40 to 3,040 (°F)
		B	18	100 to 1,800 (°C)/300 to 3,200 (°F)	0 to 1,820 (°C)/0 to 3,240 (°F)
		ES1B Infrared Temperature Sensor	10 to 70°C	19	0 to 90 (°C)/0 to 190 (°F)
	60 to 120°C		20	0 to 120 (°C)/0 to 240 (°F)	-20 to 160 (°C)/-40 to 320 (°F)
	115 to 165°C		21	0 to 165 (°C)/0 to 320 (°F)	-20 to 205 (°C)/-40 to 400 (°F)
	140 to 260°C		22	0 to 260 (°C)/0 to 500 (°F)	-20 to 300 (°C)/-40 to 580 (°F)
Analog input	0 to 50 mV	23	Any of the following ranges, by scaling: -1,999 to 9,999 -199.9 to 999.9	-5% to 105% of setting range. The display shows -1999 to 9999 (numeric range with decimal point omitted).	

	Input type	Specifications	Set value	Input temperature range	Input indication range
Controllers with Analog Inputs	Current input	4 to 20 mA	0	Any of the following ranges, by scaling: -1,999 to 9,999 -199.9 to 999.9 -19.99 to 99.99 -1.999 to 9.999	-5% to 105% of setting range. The display shows -1999 to 9999 (numeric range with decimal point omitted).
		0 to 20 mA	1		
	Voltage input	1 to 5 V	2		
		0 to 5 V	3		
		0 to 10 V	4		

- The default is 5 (°C/°F) for Controllers with Thermocouple/Resistance Thermometer Multi-Inputs and 0 for Controllers with Analog Inputs.
- The applicable standards for each of the above input ranges are as follows:
 K, J, T, E, N, R, S, B: JIS C1602-1995, IEC 584-1
 L: Fe-CuNi, DIN 43710-1985
 U: Cu-CuNi, DIN 43710-1985
 JPt100: JIS C 1604-1989, JIS C 1606-1989
 Pt100: JIS C 1604-1997, IEC 751

Control Range

- Resistance thermometer and thermocouple input
 Temperature lower limit – 20°C to temperature upper limit + 20°C, or temperature lower limit – 40°C to temperature upper limit + 40°C
- ES1B input:
 Same as input indication range
- Analog input
 –5% to +105% of scaling range

Parameter Flow

This section describes the parameters set in each level. Pressing the key at the last parameter in each level returns to the top parameter in that level.

Press the Key for at least 3 s. Displays other than that for switching between automatic and manual.

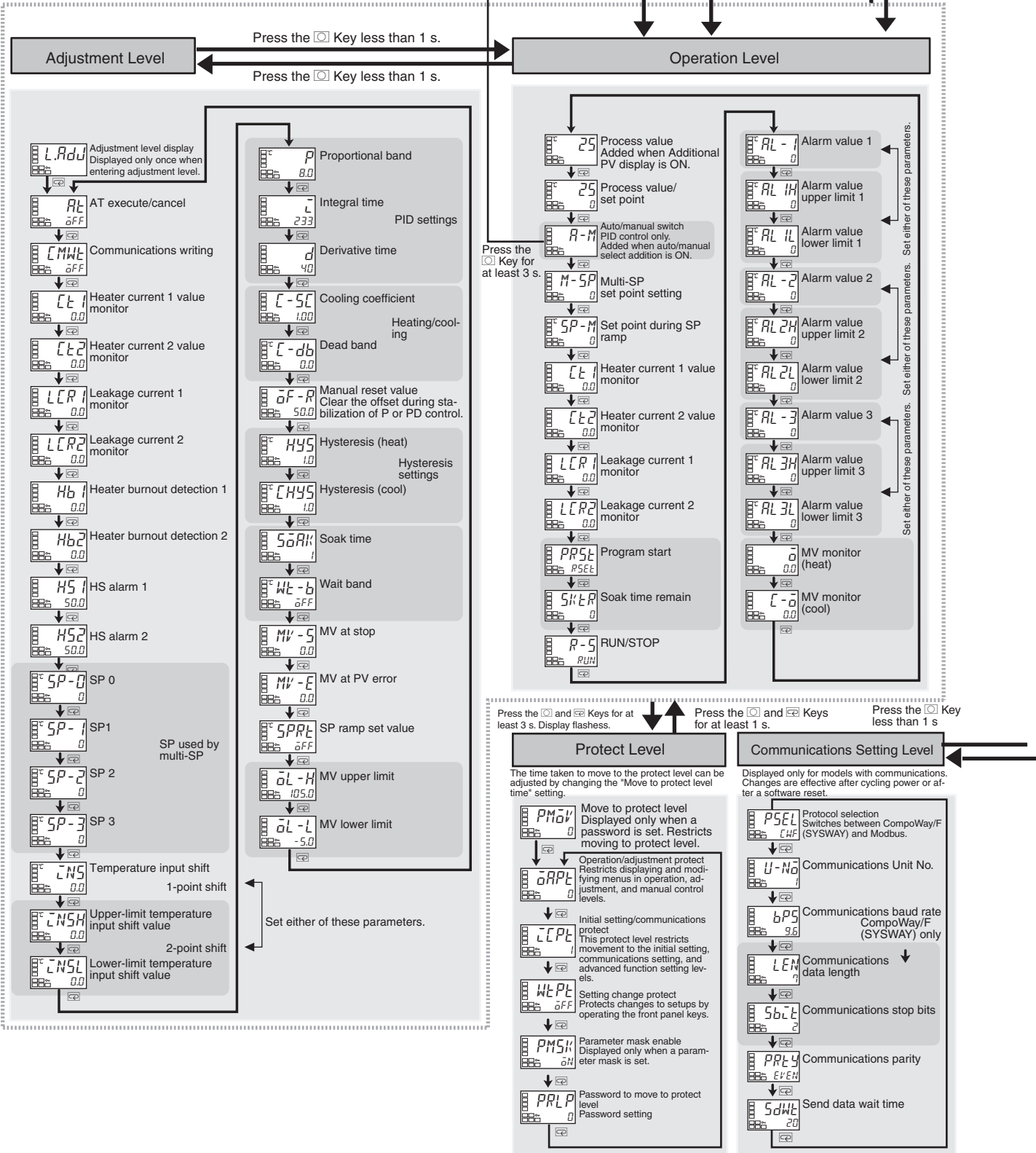

Press the Key for at least 1 s.

Initial Setting Level

Advanced Function Setting Level

Press the Key less than 1 s.

Initial Setting Level menu flow:

- Input type** (CN-E, 5)
- Scaling upper limit** (CN-H, 100)
- Scaling lower limit** (CN-L, 0)
- Decimal point** (dP, 0) *For input type of analog*
- Temperature unit** (d-U, C) *For input type of temperature*
- SP upper limit** (SL-H, 1300) *Limit the set point*
- SP lower limit** (SL-L, -200)
- PID-ON/OFF** (CNLL, ON/OFF)
- Standard or heating/cooling** (S-HC, St/Md)
- ST (self-tuning)** (St, ON) *For input type of temperature, standard control, or PID*
- Program pattern** (PLRN, OFF) *When assigning PID or control output to pulse output*
- Control period (heat)** (CP, 20) *Set the pulse output cycle.*
- Control period (cool)** (C-CP, 20)
- Direct/reverse operation** (dREV, dR-R)
- Alarm 1 type** (AL1, 2)
- Alarm 2 type** (AL2, 2)
- Alarm 3 type** (AL3, 2)
- Transfer output type** (TR-E, OFF) *Linear output*
- Transfer output upper limit** (TR-H, 100.0)
- Transfer output lower limit** (TR-L, 0.0)
- Linear output type** (o1-E, 4-20) *Linear output*
- Move to advanced function setting level** (AMOV, 0) *Displayed when initial setting/communications protection is set to 0.*

Advanced Function Setting Level menu flow:

- Parameter initialization** (CNLE, OFF)
- Number of multi-SP uses** (EV-M, Two SPs: 1, Four SPs: 2)
- Event input 1 assignment** (EV-1, NONE)
- Event input 2 assignment** (EV-2, Stop)
- Multi-SP uses** (MSPU, OFF)
- SP ramp time unit** (SPRU, M)
- Standby sequence reset** (RESL, R)
- Alarm 1 open in alarm** (ALIN, N-o)
- Alarm 1 hysteresis** (ALH1, 0.2)
- Alarm 2 open in alarm** (AL2M, N-o)
- Alarm 2 hysteresis** (ALH2, 0.2)
- Alarm 3 open in alarm** (AL3M, N-o)
- Alarm 3 hysteresis** (ALH3, 0.2)
- HB ON/OFF** (HbU, ON)
- Heater burnout latch** (HbL, OFF)
- Heater burnout hysteresis** (HbH, 0.1)
- ST stable range** (St-b, 15.0)
- Input digital filter** (ALFA, 0.65) α
- Additional PV display** (PVAd, OFF)
- MV display** (o-dP, OFF)
- Display auto-return time** (REt, OFF)
- Alarm 1 latch** (AL1L, OFF)
- Alarm 2 latch** (AL2L, OFF)
- Alarm 3 latch** (AL3L, OFF)
- Move to protect level time** (PRLE, 3)
- Input error output** (SERo, OFF)
- Cold junction compensating method** (CJC, ON)
- MB command logic switching** (ALRV, OFF)
- PV change color** (CoLR, REd)
- PV stable band** (PV-b, 5.0)
- Alarm 1 ON delay** (A1oN, 0)
- Alarm 2 ON delay** (A2oN, 0)
- Alarm 3 ON delay** (A3oN, 0)
- Alarm 1 OFF delay** (A1oF, 0)
- Alarm 2 OFF delay** (A2oF, 0)
- Alarm 3 OFF delay** (A3oF, 0)
- Input shift type** (cSLP, CNS 1)
- MV at stop and error addition** (MVSE, OFF)
- Auto/manual select addition** (AMAd, OFF)
- RT** (RT, OFF)
- HS alarm use** (HSU, ON)
- HS alarm latch** (HSL, OFF)
- HS alarm hysteresis** (HSH, 0.1)
- LBA detection time** (LbA, 0)
- LBA level** (LbAL, 8.0)
- LBA band** (LbAb, 3.0)
- Control output 1 assignment** (oUL1, o)
- Control output 2 assignment** (oUL2, NONE)
- Alarm 1 assignment** (ALM1, ALM1)
- Alarm 2 assignment** (ALM2, ALM2)
- Alarm 3 assignment (E5AN/E5EN only)** (ALM3, ALM3)
- Character select** (CSEL, ON)
- Soak time unit** (t-U, M)
- Alarm SP selection** (ALSP, SP-M)
- Move to calibration level** (CMoV, 0)

Move by setting password (-169).

Index

Numerics

2-PID control, 38, 149

A

adjustment level, 11, 129

parameter operation list, 210

advanced function setting level, 11, 157

moving to, 84, 156

parameter operation list, 213

alarm delays, 92

alarms, 8

alarm 1 assignment, 178

alarm 2 assignment, 179

alarm 3 assignment, 180

alarm delays, 92

alarm hysteresis, 71

alarm latch, 71

alarm outputs, 40, 51

alarm outputs 1 and 2

wiring, 26

alarm types, 51

alarm values, 53

operation, 72

analog input, 8, 73, 196

calibration, 192, 193

AT (auto-tuning), 45

AT execute/cancel, 45

auto control, 80

auto/manual select addition, 99, 173

auto/manual switch, 120

B

basic model

E5AN, 7

E5CN, 5

E5CN-U, 6

E5EN, 7

C

calibration

analog input, 192, 193

current input, 193

indication accuracy, 195

input types, 186

platinum resistance thermometer, 190

registering calibration data, 186

thermocouple, 186

user calibration, 186

voltage input, 194

characteristics, 200

close in alarm, 72

cold junction compensator

connecting, 187

communications

operation commands, 88

wiring

RS-232C, 29

RS-485, 28

communications function, 9

communications setting level, 12, 182

parameter operation list, 217

control outputs, 8, 40

control outputs 1 and 2

wiring, 23, 25

control periods, 38, 151

Controllers with Analog Input, 193

Controllers with Analog Inputs, 185, 194

Controllers with Thermocouple/Resistance Thermometer
Multi-input, 184, 192

cooling coefficient

setting, 76

current input

calibration, 193

current transformer

calculating detection current, 56

Current Transformers (CT), 55, 201

CT inputs

wiring, 27

external dimensions, 202

E54-CT1, 202

E54-CT3, 202

specifications, 201

Current Value Exceeds (error display), 206

D

dead band, 75

setting, 76

derivative time, 50

detection current, 56

dimensions, 16

E5AN, 16

E5CN, 16
E5CN-U, 16
E5EN, 17
direct operation, 39, 152
Display Range Exceeded (error display), 204
down key, 4

E

error displays, 202
 Current Value Exceeds, 206
 Display Range Exceeded, 204
 HB Error, 205
 Heater Burnout, 206
 HS Alarm, 206
 Input Error, 204
 Memory Error, 205
event inputs, 9, 27, 77, 78
 wiring, 27
external dimensions
 Current Transformer (CT), 202
external power supply for ES1B, 9, 29, 68, 200

F

front panel
 E5AN, 2
 E5CN, 2
 E5CN-U, 2
 E5EN, 3

H

HB Error (error display), 205
HBA (heater burnout alarm), 54
 settings, 61
Heater Burnout (error display), 206
heater burnout alarm, 9, 164, 200
heater burnout hysteresis, 164
heating/cooling control, 74, 139, 143, 150
 cooling coefficient, 75, 139
 dead band, 75, 139
 setting, 76
HS alarm, 9, 54, 200
 settings, 63
HS Alarm (error display), 206
hysteresis, 43, 45

I

I/O configuration, 5
 basic model
 E5AN, 7
 E5CN, 5
 E5CN-U, 6
 E5EN, 7
 main functions, 8
indication accuracy, 195
indicators
 meanings, 3
 operation, 3
infrared temperature sensor, 195
initial setting level, 11, 145
 parameter operation list, 211
initial setting/communications protect, 86
initial settings, 34
 examples, 34, 35
initialization, 158
input error, 142
Input Error (error display), 204
input sensor types, 8, 146
input shift, 67
 one-point shift, 67
 two-point shift, 68
 calculating, 68
input types, 36, 219
 default values, 146
 list, 37
 setting, 36
inputs
 wiring, 23
installation, 16, 18
 E5AN/E5EN
 mounting the terminal cover, 19
 mounting to the panel, 19
 E5CN/E5CN-U
 mounting the terminal cover, 19
 mounting to the panel, 19
panel cutout
 E5AN, 17
 E5CN, 17
 E5CN-U, 17
 E5EN, 18
removing from case
 E5AN, 20
 E5CN, 20
 E5EN, 20

integral time, 50

K

keys

- down key, 4
- key operations, 10
- level key, 4
- mode key, 4
- operations, 4
- up key, 4

L

LBA (loop break alarm), 94

- band, 95
- detection time, 95
- level, 95, 96

level key, 4

loop break alarm (LBA), 94

M

main functions, 8

manual control, 80, 97

manual control level, 11

- moving to, 98
- parameter operation list, 213

manual setup, 50

Memory Error (error display), 205

mode key, 4

mounting, 18

- terminal cover
 - E5AN/E5EN, 19
 - E5CN/E5CN-U, 19
- to panel
 - E5AN/E5EN, 19
 - E5CN/E5CN-U, 19

multi-SP, 78, 120, 159

MV at PV error, 111, 173

MV at stop, 110, 173

N

No. 1 display, 3

No. 2 display, 3

O

ON/OFF control, 38, 149

setting, 44

one-point shift, 69

open in alarm, 72

operation level, 11, 118

parameter operation list, 209

operation/adjustment protect, 86

output functions

assignments, 40

output limits, 110

output periods, 151

output specifications

setting, 38

P

panel cutout

- E5AN, 17
- E5CN/E5CN-U, 17
- E5EN, 18

parameter flow, 221

parameter operation list, 209

- adjustment level, 210
- manual control level, 213
- operation level, 209

parameter operation lists

- advanced function setting level, 213
- communications setting level, 217
- initial setting level, 211
- protect level, 217

parameter structure, 184

parameters

- additional PV display, 166
- adjustment level display, 130
- alarm 1 assignment, 178
- alarm 1 hysteresis, 163
- alarm 1 latch, 167
- alarm 1 OFF delay, 172
- alarm 1 ON delay, 171
- alarm 1 open in alarm, 162
- alarm 1 type, 152
- alarm 2 assignment, 179
- alarm 2 hysteresis, 163
- alarm 2 latch, 167
- alarm 2 OFF delay, 172
- alarm 2 ON delay, 171
- alarm 2 open in alarm, 162

- alarm 2 type, 154
- alarm 3 assignment, 180
- alarm 3 hysteresis, 163
- alarm 3 latch, 167
- alarm 3 OFF delay, 172
- alarm 3 ON delay, 171
- alarm 3 open in alarm, 162
- alarm 3 type, 154
- alarm SP selection, 181
- alarm value 1, 124
- alarm value 2, 125
- alarm value 3, 125
- alarm value lower limit 1, 126
- alarm value lower limit 2, 126
- alarm value lower limit 3, 127
- alarm value upper limit 1, 126
- alarm value upper limit 2, 126
- alarm value upper limit 3, 127
- alpha, 165
- AT execute/cancel, 131
- auto/manual select addition, 173
- auto/manual switch, 120
- automatic display return time, 167
- character select, 180
- cold junction compensation method, 168
- communications baud rate, 182
- communications data length, 182
- communications parity, 182
- communications stop bits, 182
- communications Unit No., 182
- communications writing, 131
- control output 1 assignment, 177
- control output 2 assignment, 178
- control period (cool), 151
- control period (heat), 151
- cooling coefficient, 139
- dead band, 139
- decimal point, 148
- derivative time, 138
- direct/reverse operation, 152
- event input assignment 1, 160
- event input assignment 2, 160
- HB ON/OFF, 163
- heater burnout detection 1, 134
- heater burnout detection 2, 134
- heater burnout hysteresis, 164
- heater burnout latch, 164
- heater current 1 value monitor, 121, 132
- heater current 2 value monitor, 122, 132
- HS alarm 1, 135
- HS alarm 2, 135
- HS alarm latch, 175
- hysteresis (cooling), 140
- hysteresis (heating), 140
- initial setting/communications protect, 116
- input digital filter, 166
- input error output, 168
- input shift type, 172
- input type, 146
- integral time, 138
- LBA band, 177
- LBA detection time, 176
- LBA level, 176
- leakage current 1 monitor, 122, 133
- leakage current 2 monitor, 123, 133
- linear current output, 156
- lower-limit temperature input shift value, 137
- manual reset value, 140
- MB command logic switching, 169
- move to advanced function setting level, 156
- move to calibration level, 181
- move to protect level, 116
- move to protect level time, 168
- multi-SP set point setting, 120
- multi-SP uses, 160
- MV (manual MV), 144
- MV at PV error, 142
- MV at stop, 142
- MV at stop and error addition, 173
- MV display, 166
- MV lower limit, 143
- MV monitor (cooling), 128
- MV monitor (heating), 127
- MV upper limit, 143
- number of multi-SP uses, 159
- operation/adjustment protect, 116
- parameter initialization, 158
- parameter mask enable, 117
- password to move to protect level, 117
- PID ON/OFF, 149
- process value, 119
- process value/set point, 120
- program pattern, 151
- program start, 123
- proportional band, 138
- protocol setting, 182
- PV change color, 169
- PV stable band, 170
- PV/MV (manual MV), 144
- RT, 174
- RUN/STOP, 124
- scaling lower limit, 148
- scaling upper limit, 148
- selecting, 12

- send data wait time, 182
- set point during SP ramp, 121
- setting change protect, 116
- soak time, 141
- soak time remain, 124
- soak time unit, 181
- SP 0, 136
- SP 1, 136
- SP 2, 136
- SP 3, 136
- SP lower limit, 149
- SP ramp set value, 143
- SP ramp time unit, 161
- SP upper limit, 149
- ST (self-tuning), 150
- ST stable range, 165
- standard or heating/cooling, 150
- standby sequence reset, 161
- temperature input shift, 136
- temperature unit, 148
- transfer output lower limit, 155
- transfer output type, 155
- transfer output upper limit, 155
- upper-limit temperature input shift value, 137
- wait band, 141
- part names
 - functions, 2
- password, 87, 88
- PID constants, 45, 47
 - setting manually, 50
- PID control
 - setting, 44
- platinum resistance thermometer, 196
 - calibration, 190
- power supply
 - wiring, 23
- precautions
 - wiring, 22
- process value (PV), 119
- program end, 107
 - output, 107
- program patterns, 105
- proportional action, 50
- proportional band, 50
- protect level, 11, 85, 115
 - moving to, 88, 116, 168
 - communications operation command, 88
 - password, 87, 117
 - parameter operation list, 217
- protection, 85

- initial setting/communications, 86, 116
- operation/adjustment, 86, 116
- setting change, 86, 116

- PV display
 - color change, 89
 - stable band, 90
- PV/MV, 144

R

- ratings, 199
- removing from case
 - E5AN/E5EN, 20
 - E5CN, 20
- reverse operation, 39, 152
- RT (robust tuning), 48, 174
- run/stop control, 79

S

- scaling
 - upper and lower limits for analog inputs, 73
- self-tuning (ST), 46, 150
- sensor input
 - control range, 219
 - indication range, 219
 - setting range, 219
- sensor types, 146
- set point (SP), 42
 - limiter, 81
 - limiting change rate, 82
 - lower limit, 82
 - ramp, 82
 - setting, 42, 44
 - setting upper and lower limits, 81
 - switching between SPs, 79
 - upper limit, 81
- setting change protect, 86
- setting level configuration, 10
- setting levels
 - diagram, 221
- settings
 - cooling coefficient, 76
 - dead band, 76
 - event input, 77
 - fixing, 12
 - HBA (heater burnout alarm), 61
 - moving to advanced function setting level, 61
 - heating/cooling control, 76

- HS alarm, 63
 - moving to advanced function setting level, 62
- hysteresis, 45
- LBA detection time, 95
- password, 88
- PID ON/OFF, 44
- SP lower limit, 82
- SP upper limit, 81
- switching between SPs, 79
- shifting input values, 67
- simple program function, 104, 109
 - controlling start, 80
 - starting, 106
- soak time, 106
- SP ramp, 82
 - alarm operations, 84
 - operation at startup, 83
 - restrictions, 83
- specifications, 199
 - Current Transformer (CT), 201
 - external power supply for ES1B, 29
 - output, 38
 - USB-Serial Conversion Cable, 203
- ST (self-tuning), 46
 - ST stable range, 47
 - startup conditions, 47
- standard control, 150
- standby sequence, 71
- startup
 - conditions, 47
 - operation, 83
- support software port, 30

T

- temperature input, 8
 - shift values, 70
- temperature unit, 4, 38
- terminals
 - arrangement
 - E5AN/E5EN, 22
 - E5CN, 21
 - E5CN-U, 22
 - wiring, 21
- thermocouple, 195
 - calibration, 186
- Thermocouple/Resistance Thermometer
 - input type, 190, 192
 - multi-input type, 192

- three-position control, 43
- transfer output, 101
 - type, 101
- troubleshooting, 206, 207, 208
- two-point shift, 68, 70
 - calculating, 68

U

- up key, 4
- USB-Serial Conversion Cable
 - specifications, 203
- user calibration, 186

V

- voltage input
 - calibration, 194

W

- wait band, 106
- wiring, 23
 - alarm outputs 1, 2, and 3, 26
 - communications
 - RS-232C, 29
 - RS-485, 28
 - control output 1, 23
 - control output 2, 25
 - CT inputs, 27
 - event inputs, 27
 - external power supply for ES1B, 29
 - inputs, 23
 - power supply, 23
 - precautions, 22
 - terminal arrangement, 21
 - terminals, 21

Revision History

A manual revision code appears as a suffix to the catalog number on the front cover of the manual.

Cat. No. H134-E1-01A



Revision code

The following table outlines the changes made to the manual during each revision. Page numbers refer to the previous version.

Revision code	Date	Revised content
01	February 2005	Original production
01A	November 2005	Page 21: Middle illustration changed. Page 138: Hysteresis (cooling) setting range corrected. Page 151: Set value of 12 added to table. Page 162: Default setting corrected to OFF. Page 197: Sensor input temperature range corrected for infrared temperature sensor.

